



Classic Single Pyrolytic Oven Instruction Manual

C2239



Contact Caple on 0117 938 7420 for spare parts or www.caple.co.uk

CONTENTS

Safety Warnings	3
Installation Warnings	7
Environmental Protection	10
Warranty	10
Installation	12
Oven Dimensions	13
Electrical Connection	14
Using Your Oven	15
Oven Functions	16
Cooking Guidelines	18
Temperatures & Times for Cooking	19
Roasting Guide	20
Touch Control Electronic Timer	21
Pyrolytic Cleaning	24
Telescopic Runners	25
Care and Maintenance	26
Replacing the Oven Lamps	27
Troubleshooting	28
Useful Notes For Baking	29
Removing the Oven Door	30
Removing the Glass Panels	31
Caple Contact Details	32

SAFETY INSTRUCTIONS

Read these instructions carefully and completely before using your appliance, keep it in a convenient place for reference when necessary.

- This appliance can be used by children aged from 8 years and above.
- Persons with reduced physical, sensory or mental capabilities or lack of experience and knowledge must be supervised and given appropriate instruction concerning the use of the appliance in a safe way and understand the hazards involved.
- Children shall not play with the appliance.
- Cleaning and user maintenance should not be carried out by children without supervision.
- The appliance is not intended to be operated by means of an external timer or separate remote control system.

WARNING:

- The appliance and its accessible parts become hot
- during use. Care should be taken to avoid touching heating elements.
- Children less than 8 years of age should be kept away unless continuously supervised.
- To prevent fire hazards do not store items on the
- cooking surfaces.
- During use, handles can get hot.
- Do not use harsh abrasive cleaners or sharp metal scrapers to clean the oven door glass or any other surface of the appliance as it can scratch the surface which may result in the glass shattering or permanent damage to the surface.
- Do not use steam cleaners for cleaning the appliance.
- Ensure the appliance is switched off before replacing the light to avoid the possibility of electric shock.

CAUTION:

- Accessible parts may be hot when the cooking or grilling is in use. Young children should be kept away.
- Your appliance is produced in accordance with all applicable local and international standards and regulations.
- Maintenance and repair work must be made only by authorised Caple service technicians. Installation and repair work that is carried out by unauthorised technicians may endanger you.
- It is dangerous to alter or modify the specifications of the appliance in any way.
- Prior to installation, ensure that the local distribution conditions (electricity voltage and frequency) and the requirements of the appliance are compatible. The requirements for this appliance are stated on the rating label.
- This appliance is designed only for cooking food and is intended for indoor use.
- This product is not designed for commercial use, it is a household appliance only. It is not intended to be used in:
 - Staff kitchen areas in shops, offices and other working environments.
 - Bed and breakfast type environments.
 - By clients in hotels, motels and other residential type environments.
- Do not try to lift or move the appliance by pulling the door handle.

- All possible security measures have been taken to ensure your safety. Since the glass may break, you should be careful while cleaning to avoid scratching.
- Avoid hitting or knocking on the glass with accessories.
- Ensure that the supply cord is not wedged during the installation. If the supply cord is damaged, it must be replaced by a Caple service technician or similarly qualified persons in order to prevent a hazard.
- While the oven door is open, do not let children climb on the door or sit on it.

INSTALLATION WARNINGS

- Do not operate the appliance before it is fully installed.
- The appliance must be installed by an authorised technician.
- Caple is not responsible for any damage that may be caused by defective placement and installation by unauthorised persons.
- When unpacking the appliance, make sure that it is not damaged during transportation. In the case of any defect; do not use the appliance and contact your retailer or Caple Service immediately.
- Materials used for packaging (nylon, staplers, styrofoam etc) may cause harmful effects to children they should be disposed of immediately.
- Protect your appliance against atmospheric effects. Do not expose it to effects such as sun, rain, snow etc.
- The surrounding materials of the appliance (i.e. kitchen cabinet or furniture) must be able to withstand a minimum temperature of 120°C.

DURING USAGE

- Before using the oven for the first time, heat the empty oven at max. temperature for 1 hour – removing any unpleasant smells and smoke caused by working residues and thermal insulation. Make sure you do this in a well ventilated area.
- During usage, the outer and inner surfaces of the oven get hot. While opening the oven door, step back to avoid the hot steam coming out of the oven as there may be a risk of burns.
- Do not put flammable or combustible materials in or near the appliance when it is operating.
- Always use oven gloves to remove and replace food in the oven.
- Pay close attention to the oven while cooking with solid or liquid oils as they could potentially catch fire when oven is hot.
- Never pour water on flames that are caused by oil. Cover the saucepan or frying pan with its lid in order to choke the flame and turn the oven off.
- If you know you will not be using the appliance for a while switch it off from the main supply and unplug it.
- The oven shelves and trays incline when pulled out. Be careful not to let hot liquid spill over.
- When the door of the oven is open, do not leave anything on it. It may unbalance your appliance or damage the door.

- Do not put anything heavy, flammable or ignitable (nylon, plastic bag, paper or cloth etc) into the oven. This includes cookware with plastic accessories (e.g. handles). Do not hang towels, dishcloths or clothes from the appliance or its handles.
- Do not use the oven for storage purposes.
- Do not touch the appliance with wet hands.
- Do not obstruct the ventilation openings.
- Do not allow supply cords from other small appliances to come into contact with the oven.
- Before operating the Pyrolytic function, ensure all internal shelves, trays and side racks are removed.
- Before use, remove all plastic films protecting some parts of the appliance (fascia - panel, parts in stainless steel, etc)
- Do not use the appliance to heat a room.
- When the appliance is not in use, we recommend you turn it off, and isolate it from the electrical supply.

DURING CLEANING AND MAINTENANCE

- Always switch off the appliance from the mains isolating the electrical supply before any cleaning or maintenance.
- To maintain the efficiency and safety of your appliance, we recommend you always use original spare parts and to call only our authorised Caple Service agents in case of need.



ENVIRONMENTAL PROTECTION

Waste electrical products should not be disposed of with household waste. Please recycle where facilities exist. Check with your Local Authority or retailer for recycling advice. This appliance is marked according to the European directive on Waste Electrical and Electronic Equipment (WEEE).

By ensuring this product is disposed of correctly, you will help prevent potential negative consequences for the environment and human health, which could otherwise be caused by inappropriate waste handling of this product. The symbol on the product indicates that this product may not be treated as household waste. Instead it shall be handed over to the applicable collection point for the recycling of electrical and electronic equipment. Disposal must be carried out in accordance with local environmental regulations for waste disposal.

For more detailed information about treatment, recovery and recycling of this product, please contact your local council, your household waste disposal service or the retailer where you purchased the product.

WARRANTY

Your new appliance is covered by warranty. The warranty card is enclosed - if it is missing, you must provide the following information to your retailer in order to receive a replacement: date of purchase, model and serial number. Registration can also be completed online by visiting www.caple.co.uk.

Ensure you keep your warranty card safe, you may need to show it to Caple Service together with proof of purchase.

If you fail to show your warranty card you will incur all repair charges.

Spare parts are only available from Caple Service and spare parts authorised centres.

CE DECLARATIONS OF CONFORMITY



This appliance has been manufactured to the strictest standards and complies with all applicable legislation, Low Voltage Directive (LVD) and Electromagnetic Compatibility (EMC).

UKCA DECLARATIONS OF CONFORMITY



This appliance has been manufactured to the strictest standards and complies with all applicable legislation.

TECHNICAL FICHE

This appliance conforms to all current and applicable energy regulations. To view the Technical Fiche that supports the energy labelling data, please visit the product page on our website www.cable.co.uk

INSTALLATION

IMPORTANT:

ISOLATE YOUR OVEN FROM THE ELECTRICAL SUPPLY BEFORE PERFORMING INSTALLATION OR MAINTENANCE.

Installation should be carried out according to the instructions by a professionally qualified person only.

The manufacturer declines all responsibility for any damage to persons, animals or materials due to incorrect installation.

FITTING THE APPLIANCE:

Fit the appliance into its surround (beneath a worktop or above another appliance in a tall housing) by inserting screws and plastic covers into the 2 holes (A - fig.3) that can be seen in the frame of the oven when the door is open.

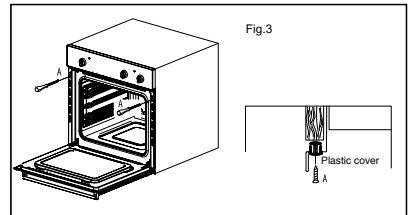

For the most efficient air circulation, the oven should be fitted according to the dimensions shown in fig. 1 & 2.

The rear panel of the cabinet must be removed so that air can circulate freely. The panel to which the oven is fitted should have a gap of at least 70 mm at the rear for ventilation (fig.4 & fig.5).

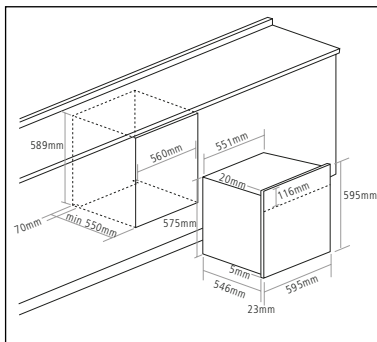

Fig1

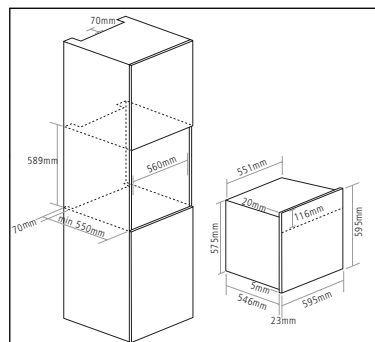
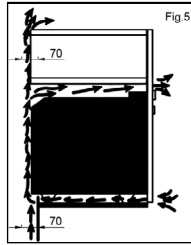
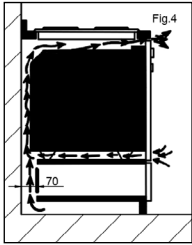

Fig2



See below for full dimensional drawings of your oven to help with installation.

For a built-in oven to work well the cabinet must be of the right type.

The panels of the adjoining furniture should be heat resistant. Particularly when the adjoining furniture is made of veneered wood, the adhesives should be able to withstand a temperature of 120°C. Plastic materials or adhesive which cannot withstand this temperature may become deformed or unstuck.

To comply with safety regulations, once the appliance has been fitted it should not be possible to make contact with the electrical parts.

All parts which offer protection should be fixed in such a way that they cannot be removed without the use of a tool.

OVEN DIMENSIONS

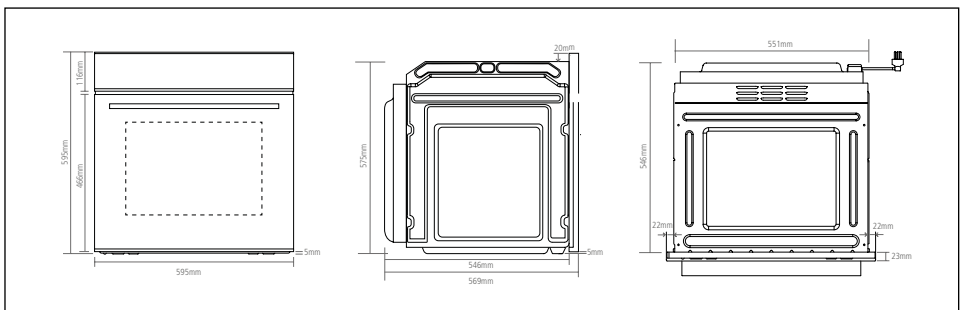

ELECTRICAL CONNECTION

WARNING: THIS APPLIANCE MUST BE EARTHED

Check that the power rating of the mains supply is suitable for the maximum power of the appliance as indicated on the rating label.

The fuse rating for this appliance is 20amp.

The appliance is supplied with a mains lead it should be "Hard wired" as follows:

- › The "yellow/green" earth wire, which must be connected to a terminal, and has to be about 10mm longer than the other wire.
- › The neutral wire has to be connected to the terminal marked with a letter N.
- › The Live wire should only be connected to the terminal marked L.

Mains connection can also be made by fitting a double pole switch with a minimum gap between the contacts of 3mm, proportionate to the load and complying with the regulations in force.

The yellow/green earth wire should not be controlled by the switch.

When a double pole switch is used for mains supply connection it should be easily accessed, once the appliance is in position.

IMPORTANT:

The mains supply cable should be positioned so that it is never subjected to temperatures which are more than 50°C above ambient temperature.

The electrical safety of the appliance can only be guaranteed when it has been correctly connected to a properly earthed mains electrical supply, as laid down in the current regulations for electrical safety.

The manufacturer cannot be held responsible for any damage to persons or objects due to lack of an earth connection.

The ovens are designed to operate with a mono-phase alternating current of 220-240V, 50Hz.

Before the installation of the appliance, check the specifications on the rating label.





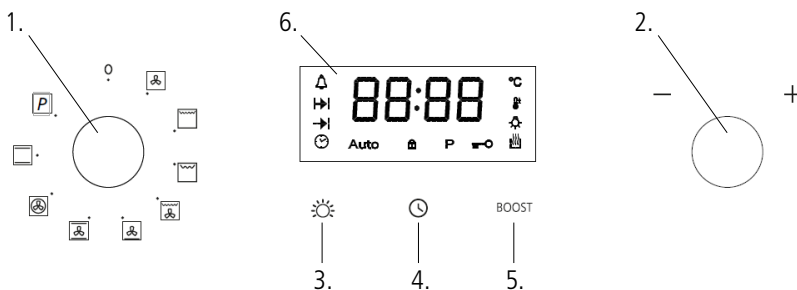







USING YOUR OVEN

CONTROL PANEL:



1. Function control knob
2. Temperature control knob (+/-)
3. Light
4. Timer
5. Boost
6. Display screen

OVEN FUNCTIONS

	LIGHT	Internal oven light.
	CONVENTIONAL HEAT	Both the lower and upper heating elements operate together. This is the traditional cooking method, perfect for roasting joints, cooking pastry and baking cakes.
	TURBO DEFROST	The air at ambient temperature is distributed inside the oven to speed up defrosting time.
	FAN HEAT	Both the fan and the circular heating element operate together. The fan evenly distributes the hot air (between 50°C and MAX) inside the oven. This is ideal for cooking several types of food e.g. meat and fish, at the same time without affecting taste and smell. It is also ideal for delicate pastries.
	TURBO BASE HEAT	Both the fan and the lower heating element operate together. The air which is heated by the lower heating element is circulated by the fan helping to distribute the heat. This function can be used for sterilising glass jars.
	ECO GRILL	This function can be used for grilling and gratinating small quantities of food. This function can be used with the door closed.
	FULL GRILL	This function can be used for grilling and gratinating food. When grilling, the oven door must be closed.
	TURBO GRILL	This function can be used for grilling and gratinating food quicker than other grill functions. When grilling, the oven door must be closed.
	TURBO CONVENTIONAL HEAT	This function uses both top and bottom heating elements simultaneously. The heat produced by these is then circulated around the oven by the fan to help distribute the heat more evenly.
	BOOST	Press the Boost button once a function and temperature have been selected to activate the rapid preheat boost function. When the oven reaches the set temperature, the boost function will automatically turn off. The Boost function is only available with the following 3 functions:   
	PYROLYTIC CLEANING	When the Pyrolytic cleaning function is selected, the door will lock, and the oven will reach extremely high temperatures to clean the inside of the oven. Ensure all the shelves, trays and side racks are removed before selecting this function. Note: All functions will start automatically 5 seconds after being selected.

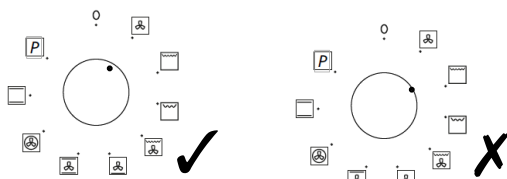

WARNING:

When selecting a function, ensure the function control knob is placed directly in line with the required function, and not in-between two functions.





COOKING GUIDELINES

- › Set the function for the type of cooking required.
- › Preheat the oven, setting the thermostat to the required temperature. Once the oven has heated to the selected temperature, the orange temperature indicator light will go out.
- › This same light will appear again automatically during operation of the oven to indicate that the heating elements are on.
- › Remove the drip tray when using the oven for conventional cooking, roasting etc. The tray should be left in place only when using the grill, as its purpose is to catch falling droplets of fat. Food should be placed in oven dishes with raised edges and positioned centrally under the grill.
- › If the fan heat operation is selected, different foods can be cooked simultaneously (e.g. meat and fish), although in this case the respective cooking time must be observed.

COOKING FUNCTION	FOOD TYPE	SHELF POSITION	TEMPERATURE (°C)	TIME (MINS)	
Conventional cooking 	Yorkshire Pudding	1	200	30-40	
	Sponge Cake	1	180	25-30	
	Small Cakes	2	190	15-20	
	Fruit Tart	1	200	40-45	
	Scones	2	220	10-15	
	Fruit Cake	1	140	120-180	
Grilling 	Pork chops (4 pcs)	5	250	Side 1 15	Side 2 12
	Steak (4 pcs)	5	250	10	8
	Sausages (6 pcs)	5	250	9	6
	Toast (6 pcs)	5	250	1	1

TEMPERATURES AND TIMES FOR COOKING

DISHES	TEMPERATURE (°C)		TIME (MINS)
			
SWEET			
Short pastry flan	200	190	8-10
Fruit pie/tart	200	190	25-35
Shortcake biscuits	200	190	10-15
Savoury biscuits	200	190	15-20
MEAT			
Slow roast	175	170	12-15
Quick roast	200	190	12-15
Meat loaf	200	190	30-40
POULTRY			
Duck 1.5-2kg	200	170	120-180
Goose 3kg	200	180	150-210
Roast chicken	200	190	60-90
Turkey 5kg	175	150	240
GAME			
Hare	200	180	60-90
Haunch of venison	175	175	90-180

- › Frozen meat should be thoroughly thawed before cooking. For large joints it is advisable to thaw overnight.
- › Frozen poultry should be thoroughly thawed before cooking. The time required depends on the size of the bird e.g. a large turkey may take up to 48 hours to thaw.
- › Adjust the shelf position so the meat or poultry will be in the centre of the oven.
- › The times given in the roasting guide are only approximate because the size and age of the bird will influence cooking times, as will the shape of a joint and the proportion of bone.

ROASTING GUIDE

COOKING IN OVEN 180°C Fan heat 200°C Conventional heat		TIME
Beef	Rare Medium Well done	20 minutes per 450g (1lb) plus 20 minutes 25 minutes per 450g (1lb) plus 20 minutes 30 minutes per 450g (1lb) plus 30 minutes
Lamb	Medium Well done	25 minutes per 450g (1lb) plus 25 minutes 30 minutes per 450g (1lb) plus 30 minutes
Pork		35 minutes per 450g (1lb) plus 35 minutes
Fowl		20 minutes per 450g (1lb) plus 20 minutes

NOTE:

- › If you are cooking a very large turkey, we recommend that it is turned around halfway through cooking, so that both legs will be cooked evenly.
- › Remove any excess fat from the tin before turning, to prevent any fat splashing.
- › When cooking stuffed meat or poultry, calculate the cooking time from the total weight of the meat plus the stuffing.
- › For joints cooked in foil and for lidded casseroles, add 5 minutes per 450g (1lb) to the calculated cooking time.
- › Smaller joints weighing less than 1.25kg (2lb) may require 5 minutes per 450g (1lb) extra cooking time.

TOUCH CONTROL ELECTRONIC TIMER





NOTE:

The oven only operates when the time has been set.

SETTING AND CHANGING THE TIME



BOOST

- › When the appliance has been connected to the electrical supply or when there has been a power cut, the time indicator  flashes automatically.
- › To change the time that has already been set, press the time button  repeatedly, until the time indicator  flashes.
- › Set the current time using the + or - button. After approx. 5 seconds, the flashing stops and the clock display the time of day set.
- › The appliance is now ready to use.
- › The time can only be changed if neither of the automatic functions (cook time  or end time ) has been set.

TIMER FUNCTIONS

Countdown 

- › To set a countdown, a signal sounds after the time has elapsed.
- › This function does not affect the operation of the oven.

Cook Time 

- › To set how long the oven is to be in use.



End Time 

- › To set when the oven is to switch off again.



Time 

- › To set, change or check the time.



HOW TO USE THE CLOCK FUNCTION

- › When a function has been selected, the corresponding function indicator flashes for approx. 5 seconds. During this time the desired times can be set using the + / – control knob.
- › When the desired time has been set, the function indicator flashes for approx. another 5 seconds. After that the function indicator is then lit. The set time begins to run.
- › Press any of the buttons to stop the acoustic signal.
- › The desired oven function and temperature can be selected before or after the clock functions of cook time  and end time  are set.
- › When the cooking time has ended, turn the oven function and temperature dial back to the OFF position.

COUNTDOWN

- › Press  button repeatedly, until the countdown indicator  flashes.
- › Using the + / – control knob, set the required countdown (max. 2 hours 30 minutes).
- › After approx. 5 seconds, the display shows the remaining time.
- › The countdown indicator  will light up.
- › When the time has elapsed, the function indicator flashes and an acoustic signal sounds for 2 minutes. Press any button to switch off the signal.

COOK TIME

- › Press selection button  repeatedly, until the cook time indicator  flashes.
- › Using the + / – control knob, set the required cooking time.
- › After approx. 5 seconds, the display returns to the current time. The cook time indicator  will flash and AUTO symbol will appear in the display.
- › When the time has elapsed, the cook time indicator will flash, an acoustic signal will sound for 2 minutes and the oven will switch itself off. Press any button to switch the signal and the programme off.



END TIME →

- › Press selection button  repeatedly, until the end time indicator → flashes.
- › Using the + / – control knob, set the required switch-off time.
- › After approx. 5 seconds, the display returns to the current time.
- › The end time indicator → will light up.
- › When the time has lapsed, the function indicator will flash, an acoustic signal will sound for 2 minutes and the oven will switch itself off. Press any button to switch the signal and the programme off.

COOK TIME ⇨ AND END TIME →

- › Cook time ⇨ and end time → can be used simultaneously, if you want the oven to be automatically switched on and off at a specific time.
- › Using the cook time function ⇨ set the period of time that the dish requires to cook. For example, 1 hour.
- › Using the end time function →, set the time at which the dish is to be ready. In this example, 14:05.
- › The cook time ⇨ and end time → light up and the time is shown in the display. In this example, 12:05.
- › The oven will automatically switch itself on at the appropriate time - in this example, at 13:05 - and will switch itself off when the cooking time set has elapsed. In this example, at 14:05.

CHILDREN SAFETY LOCK 🔒

- › Press  for 5 seconds to activate the child safety lock. The display shows 🔒.
- › When the child safety lock is activated, the buttons are all locked.
- › Press  for 5 seconds to cancel the child safety lock.

PYROLYTIC CLEANING



With the Pyro clean mode, the internal temperature of the oven reaches 475°C. The pyrolytic cycle is activated, burning away food and grime residues. Dirt is literally incinerated. Keep children away from the appliance during the automatic cleaning cycle as surfaces may become very hot. Particles may ignite inside the oven due to the combustion process. There is no cause for concern: this process is both normal and hazard-free.

Before initiating the Pyro clean mode:

- › Remove large or coarse food residues from the inside of the oven using a damp sponge. Do not use detergents.
- › Remove all accessories.
- › Remove the side racks, telescopic runners, trays and wire shelves.
- › Do not place tea towels or pot holders over the oven handle.
- › Ensure any tin foil is removed from the oven cavity.

NOTE:

If the oven is too hot, the pyrolytic may not start. Wait for the oven to cool down.

- › Select the Pyrolytic function  with the Function Control knob, the display shows **P**, and the cooking time indicator  flashes.
- › Using the +/- Control knob, set the required pyrolytic time 1:15, 1:30 or 2:00.
- › After approx.. 5 seconds, pyrolytic cleaning will start.

SAFETY DEVICES

- › The icon  on the display, when lit, indicates that the oven door was automatically locked as soon as the temperature reached a high value.
- › If a malfunction occurs, the heating elements will be switched off.
- › Once the oven door has been locked, you cannot change the duration and cycle end time settings.

ONCE THE PYROLYTIC CLEANING CYCLE IS OVER

You will have to wait until the temperature inside the oven has cooled down sufficiently before you can open the oven door. You will notice some white dust deposits on the bottom and the sides of your oven; remove these deposits with a damp sponge once the oven has cooled down completely alternatively, you can make use of the already heated oven, in which case it is not necessary to remove the deposits, they are completely harmless and will not affect your food in any way.

TELESCOPIC RUNNERS

To assemble the telescopic runners:

- › Remove the side racks (see section below and Fig.2)
- › Choose which shelf to use with the telescopic runner. Paying attention to the direction in which the runner is to be extracted, position joint 'B' and joint 'C' on the frame (see Fig.1).
- › Squeeze the bars together slightly and clip either end of the telescopic runners on to the side racks.
- › Finally, refit the side racks (See below and Fig.2)

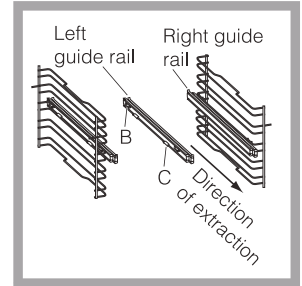

Figure 1.

NOTE:

Telescopic runners are optional accessories and are not included.

SIDE RACKS

Attach the side racks by pushing these onto the furthest steel clip and then clicking the other end onto the closest steel clip.

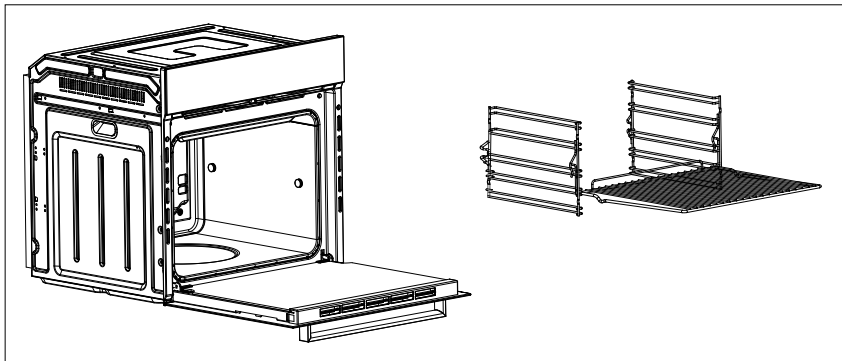

Figure 2.

CARE AND MAINTENANCE

IMPORTANT:

Unplug your oven before cleaning, or performing maintenance!

To extend the life of your oven, it must be cleaned frequently, keeping in mind the following:

DO NOT USE STEAM EQUIPMENT TO CLEAN THE APPLIANCE

- › To protect against the risk of electrical shock, do not immerse the unit, cord or plug in water or other liquid, or sprinkle water to clean the appliance!
- › Don't clean the appliance when it is still hot! The inside and external surfaces of the oven should preferably be cleaned with a damp cloth when it has cooled down.
- › Wash all accessories in hot soapy water or in a dishwasher, wipe dry with a paper towel or cloth.
- › If you use your oven for an extended period of time, condensation may form.
- › Dry it using a soft cloth.
- › There is a rubber seal surrounding the oven opening which guarantees its perfect functioning. Check the condition of this seal on a regular basis. If necessary, clean it and avoid using abrasive products or objects to do so. Should it become damaged, please contact Caple service. We recommend you avoid using the oven until it has been repaired.
- › Never line the oven bottom with aluminium foil, as the consequent accumulation of heat could compromise the cooking and even damage the enamel.
- › Clean the glass door using a damp cloth and dry it with a soft cloth.
- › Do not use harsh abrasive cleaners or sharp metal scrapers to clean the oven door glass since they can scratch the surface, which may result in shattering of the glass.

REPLACING THE OVEN LIGHT

- › Switch off your oven at the mains.
- › Remove the glass cover, by unscrewing this from the light socket.
- › Remove the light bulb by pulling it from the light socket and replace it with a similar bulb.
- › Remount the glass cover and reconnect the appliance to the power supply.

HALOGEN LIGHT CHARACTERISTICS

- › Voltage: AC220V-240V
- › Wattage: 25W
- › Cap: G9

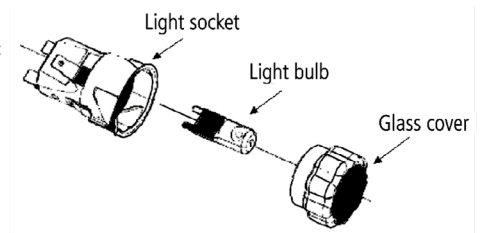
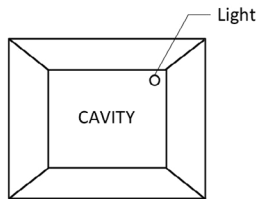

DO NOT TOUCH the light bulb directly with your hands.

WARNING:

Ensure that the appliance is disconnected from the mains before replacing the light to avoid the possibility of electric shock.

TROUBLESHOOTING

TROUBLES	SOLUTION
The oven does not operate	<ul style="list-style-type: none"> › Check it is switched on at the mains › There has been a power cut › The time is not set
The oven is not heating	<ul style="list-style-type: none"> › The thermostat is not turned to a temperature
The interior light does not illuminate	<ul style="list-style-type: none"> › Check the product is connected to the electrical supply and is switched on › Replace the bulb
Lower and upper parts of the oven are not cooking evenly	<ul style="list-style-type: none"> › Control the shelf location, cooking period and temperatures according to the manual

ERROR CODES

DISPLAY	ERROR	REASON
E 01	No sensor	Temperature might be too high; oven will stop working and cooling fan start.
E 02	Sensor short circuit	Wrong sensor. Oven will stop working and cooling fan start.
E 03	Door lock	Under pyrolytic mode, heating element will stop working until door is locked well.

If the problem still persists, please contact Caple service for assistance:

T - 0117 938 7420

E - service@caple.co.uk

USEFUL NOTES FOR BAKING

In the following table are some indicative hints for baking:

FAULTS	CAUSES	REMEDIES
The upper crust is dark and the lower part too pale	Not enough heat from the bottom	<ul style="list-style-type: none">› Use the natural convection position› Use deeper cake tins› Lower the temperature› Put the cake on a lower shelf
The lower part is dark and the upper crust too pale	Excessive heat from the bottom	<ul style="list-style-type: none">› Use the natural convection position› Use lower side tins› Lower the temperature› Put the cake on a higher shelf
The outside is too cooked and the inside not cooked enough	Too high temperature	<ul style="list-style-type: none">› Lower the temperature and increase the cooking time
The outside is too dry even though it is the right colour	Too low temperature	<ul style="list-style-type: none">› Increase the temperature and reduce the cooking time.

REMOVING THE OVEN DOOR

To make it easier to clean the inside of your oven, the oven door can be easily removed by proceeding as follows:

- › Open the door completely and lift the 2 levers "B" (Fig.1);
- › Now, shutting the door slightly, you can lift it out by pulling out the hooks "A" as shown in Fig.2.

TO REASSEMBLE THE DOOR:

- › With the door in a vertical position, insert the two hooks "A" into the slots;
- › Ensure that seat "D" is hooked perfectly onto the edge of the slot (move the oven door backwards and forward slightly);
- › Keep the oven door open fully, unhook the 2 levers "B" downwards and then shut the door again.

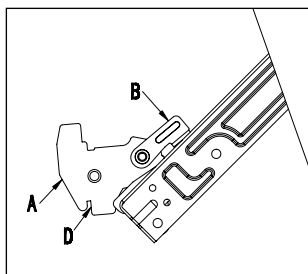

Fig.1

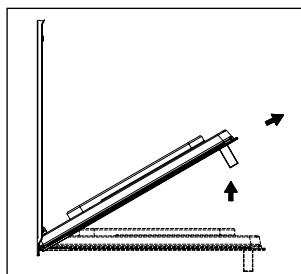

Fig.2

Scan the QR code below to access the 'How to video'.



REMOVING THE GLASS PANELS

The oven door is made up of 4 panes of glass and has vents at the top and bottom. When the oven is operating, air is circulated through the door to keep the outer pane cool. If condensation has worked its way in between the glass panes, the door can be dismantled in order to clean in between the panes. Remove the door as per the below instructions and place it on a protective surface (e.g. on a table cloth) to prevent it getting scratched. The door handle should line up with the edge of the table. Make sure the glass lies flat to avoid breakage of glass during cleaning.

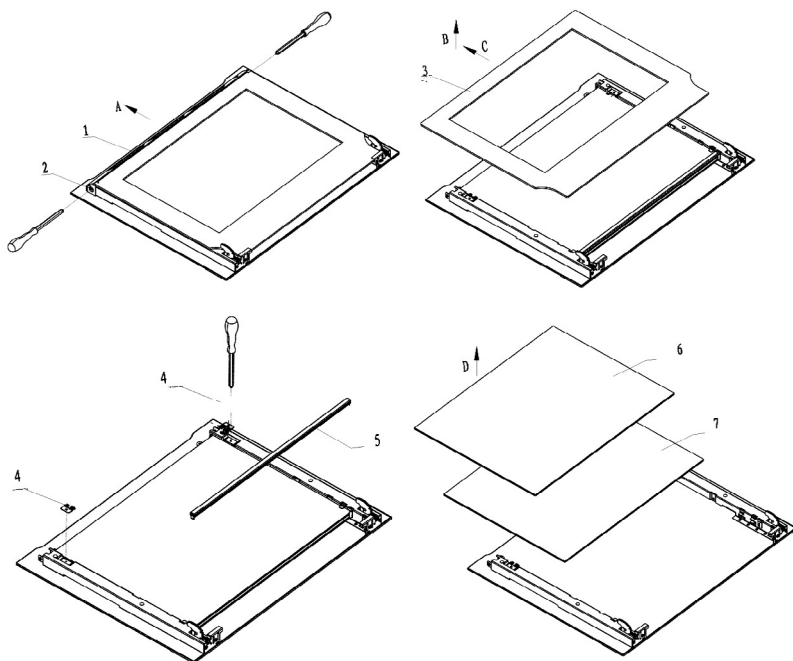



Caple Service
Fourth Way
Avonmouth
Bristol
BS11 8DW

T: 0117 938 1900
E: service@caple.co.uk
www.caple.co.uk