

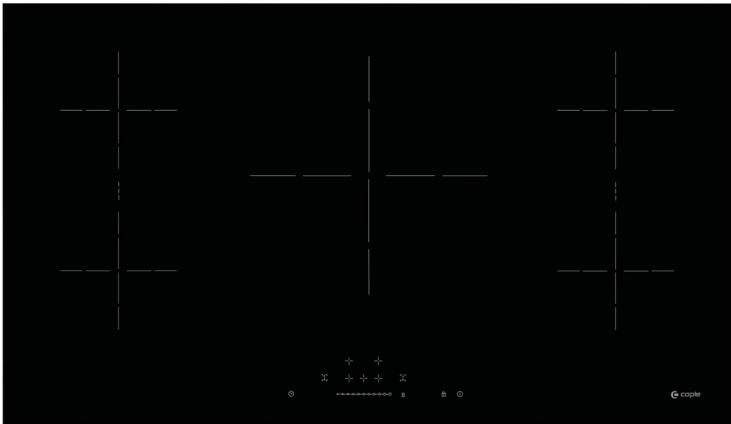

# Induction Hob Instruction Manual

---

# C897i



Contact Caple on 0117 938 7420 for spare parts or [www.caple.co.uk](http://www.caple.co.uk)

## CONTENTS

---

Safety Instructions	3
Environmental Protection	10
Warranty	10
Product Description	11
Using Your Induction Hob	15
Cooking Guidelines	24
Installation	27
Cleaning and Maintenance	32
Troubleshooting	33
Failure display error codes	34
Technical Specification	35
Caple Contact Details	36

## **INTRODUCTION**

Congratulations on the purchase of your new Caple induction hob. We recommend that you spend some time reading instruction manual in order to fully understand how to correctly install and operate your hob. For installation, please read the installation section. Read all the safety instructions carefully before using your hob and keep this instruction manual for future reference.

## **SAFETY INSTRUCTIONS**

Your safety is important to us. Please read this information before using your hob.

## **INSTALLATION**

### **ELECTRICAL SHOCK HAZARD**

- Disconnect the appliance from the mains electricity supply before carrying out any work or maintenance on it.
- Connection to a good earth wiring system is mandatory.
- Alterations to the domestic wiring system must only be made by a qualified electrician.
- Failure to follow this advice could be fatal or seriously injure the user.

### **CUT HAZARD**

- Take care - panel edges are sharp. Failure to do so may result in injury or cuts.

## **IMPORTANT SAFETY INSTRUCTIONS**

- Read these instructions carefully before installing or using this appliance.
- No combustible materials or products should be placed on this appliance at any time.
- Please make this information available to the person responsible for installing the appliance.
- In order to avoid a hazard, this appliance must be installed according to these instructions.
- This appliance is to be installed correctly and earthed only by a suitably qualified person.
- This appliance should be connected to a circuit which incorporates an isolating switch providing full disconnection from the power supply.
- Failure to install the appliance correctly could invalidate any warranty or liability claims.

## **OPERATION AND MAINTENANCE WARNINGS**

### **ELECTRICAL SHOCK HAZARD**

- Do not cook on a broken or cracked hob. If the hob surface should break or crack, switch the appliance off immediately at the main power supply (wall switch) and contact a qualified technician.
- Switch the hob off at the wall before cleaning or maintenance.

- Failure to follow this advice could be fatal or seriously injure user.

## **HEALTH HAZARD**

- This appliance complies with electromagnetic safety standards.
- Persons with cardiac pacemakers or other electrical implants must consult their doctor before using this appliance to ensure the implants will not be affected by the electromagnetic field.
- Failure to follow this advice could be fatal or seriously injure the user.

## **HOT SURFACE HAZARD**

- During use, accessible parts of this appliance will become hot enough to cause burns.
- Do not let your body, clothing or any item other than suitable cookware contact the induction glass until the surface is cool.
- Metallic objects such as knives, forks, spoons and lids should not be placed on the hob surface.
- Keep children away from appliance.
- Handles of saucepans may be hot to touch. Check saucepan handles do not overhang other cooking zones that are on. Keep handles out of reach of children.
- Failure to follow this advice could result in burns and scalds.

## IMPORTANT SAFETY INSTRUCTIONS

- Never leave the appliance unattended when in use as pans may boil over which may result in smoking or grease spills that may ignite.
- Never use your appliance as a work or storage surface.
- Never leave any objects or utensils on the appliance.
- Do not place or leave any magnetic objects (e.g. credit cards, memory cards) or electronic devices (e.g. computers, mobile phones, MP3 players) near the appliance, as they may be affected by its electromagnetic field.
- Never use your appliance for warming or heating the room.
- After use, always turn off the cooking zones and the hob as described in this manual (i.e. by using the touch controls). Do not rely on the pan detection feature to turn off the cooking zones when pans are removed.
- Do not allow children to play, sit, stand, or climb on the appliance.
- Do not store childrens toys in cabinets above the appliance to avoid the risk of children climbing on the hob as this could result in serious injury.
- Do not leave children alone or unattended in the kitchen when the hob is in use.
- Persons with reduced physical, sensory or mental capabilities or lack of experience and knowledge must be supervised and given appropriate instruction concerning the use of the appliance in a safe way and understand the hazards involved.

- Do not repair or replace any part of the appliance unless specific instructions are detailed in the manual. All other servicing should be done by a qualified technician.
- Do not use a steam cleaner to clean the hob.
- Do not place or drop heavy objects on your hob.
- Do not stand on your hob.
- Do not use pans with jagged edges or drag pans across the surface as this can scratch the glass.
- Do not use scourers or any other harsh abrasive cleaning agents to clean your hob, as these can scratch glass.
- If the supply cord is damaged, it must be replaced by Caple service or similarly qualified persons in order to avoid a hazard.
- This appliance is intended to be used in household and similar applications such as:
  - › Staff kitchen areas in shops, offices and other working environments.
  - › Farm Houses.
  - › By clients in hotels, motels and other residential type environments.
  - › Bed and breakfast type environments.

## **WARNING:**

- **WARNING:** The appliance and its accessible parts become hot during use.
- Care should be taken to avoid touching heating elements.
- Children less than 8 years of age shall be kept away unless continuously supervised.
- This appliance can be used by children aged from 8 years and above and persons with reduced physical, sensory or mental capabilities or lack of experience and knowledge if they have been given supervision or instruction concerning use of the appliance in a safe way and understand the hazards involved.
- Children should not play with the appliance.
- Cleaning and user maintenance should not be carried out by children without supervision.
- **WARNING:** Unattended cooking on a hob with fat or oil can be dangerous and may result in fire. NEVER try to extinguish a fire with water, but switch off the appliance and then cover flame e.g. with a lid or a fire blanket.
- **WARNING:** Danger of fire: do not store items on the cooking surfaces.
- **WARNING:** If the glass/ceramic surface is cracked it can expose live parts, switch off the appliance to avoid the possibility of electric shock.
- Do not steam clean.
- The appliance is not intended to be operated by means of an external timer or separate remote control system.

## **WARNING:**

- Warning: If the surface is cracked, switch off the appliance to avoid the possibility of electric shock. Hob surfaces that are glass-ceramic or of a similar material protect live parts.
- The appliance is not intended to be operated by means of an external timer or separate remote-control system.
- The cooking process has to be supervised. A short term cooking process has to be supervised continuously.
- Unattended cooking on a hob with fat or oil can be dangerous and may result in fire. NEVER try to extinguish a fire with water, but switch off the appliance and then cover flame e.g. with a lid or a fire blanket.



## ENVIRONMENTAL PROTECTION

Waste electrical products should not be disposed of with household waste. Please recycle where facilities exist. Check with your Local Authority or retailer for recycling advice. This appliance is marked according to the European directive on Waste Electrical and Electronic Equipment (WEEE). By ensuring this product is disposed of correctly, you will help prevent potential negative consequences for the environment and human health, which could otherwise be caused by inappropriate waste handling of this product. The symbol on the product indicates that this product may not be treated as household waste. Instead it shall be handed over to the applicable collection point for the recycling of electrical and electronic equipment. Disposal must be carried out in accordance with local environmental regulations for waste disposal. For more detailed information about treatment, recovery and recycling of this product, please contact your local council, your household waste disposal service or the retailer where you purchased the product.

## CE DECLARATIONS OF CONFORMITY



This appliance has been manufactured to the strictest standards and complies with all applicable legislation, Low Voltage Directive (LVD) and Electromagnetic Compatibility (EMC).

## UKCA DECLARATIONS OF CONFORMITY



This appliance has been manufactured to the strictest standards and complies with all applicable legislation.

## TECHNICAL FICHE

This appliance conforms to all current and applicable energy regulations. To view the Technical Fiche that supports the energy labelling data, please visit the product page on our website [www.caple.co.uk](http://www.caple.co.uk)

## WARRANTY

Your new appliance is covered by warranty. The warranty card is enclosed - if it is missing, you must provide the following information to your retailer in order to receive a replacement: date of purchase, model and serial number. Registration can also be completed online by visiting [www.caple.co.uk](http://www.caple.co.uk).

Ensure you keep your warranty card safe, you may need to show it to Caple Service together with proof of purchase.

If you fail to show your warranty card you will incur all repair charges. Spare parts are only available from Caple Service and spare parts authorised centres.

## PRODUCT DESCRIPTION

### TOP VIEW

1. max. 1800/2300 W zone
2. max. 1800/2300 W zone
3. max. 3000/3600 W zone
4. max. 2200/3000 W zone
5. max. 1800/2300 W zone
6. max. 1800/2300 W zone
7. max. 3000/3600 W zone
8. Control Panel

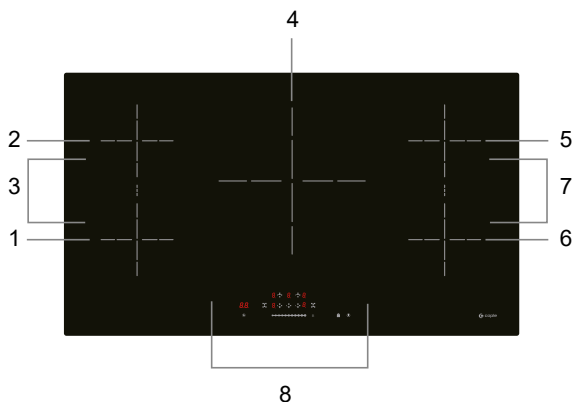

### CONTROL PANEL

1. Heating zone selection controls
2. Timer control
3. Boost control
4. Keylock control
5. ON/OFF control
6. Bridge control

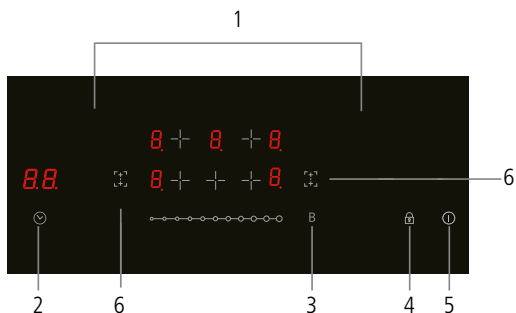

## INDUCTION COOKING

Induction cooking is a safe, advanced, efficient, and economical cooking technology. It works by electromagnetic vibrations generating heat directly in the pan, rather than indirectly through heating the glass surface. The glass becomes hot only because the pan eventually warms it up.

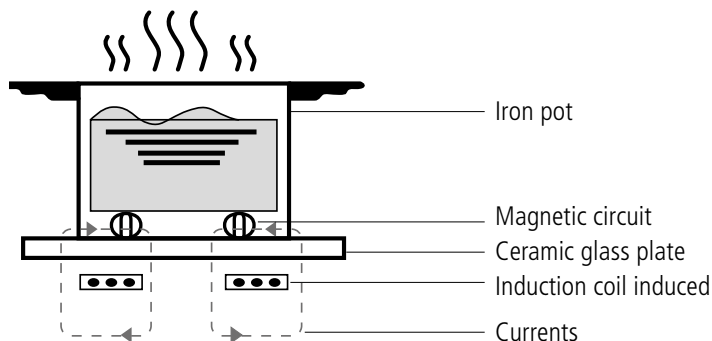

## BEFORE USING YOUR NEW INDUCTION HOB

- › Read this guide, taking special note of the 'Safety Warnings' section.
- › Remove any protective film that may still be on your Induction hob.

## USING THE TOUCH CONTROLS

- › The controls respond to touch, so you don't need to apply any pressure.
- › Use the ball of your finger, not its tip.
- › You will hear a beep each time a touch is registered.
- › Make sure the controls are always clean, dry, and that there is no object (e.g. a utensil or a cloth) covering them. Even a thin film of water may make the controls difficult to operate.

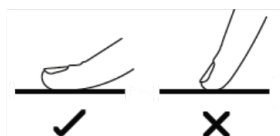

## CHOOSING THE RIGHT COOKWARE

›  Only use cookware with a base suitable for induction cooking. Look for the induction symbol on the packaging or on the bottom of the pan.

› You can check whether your cookware is suitable by carrying out a magnet test. Move a magnet towards the base of the pan. If it is attracted, the pan is suitable for induction.

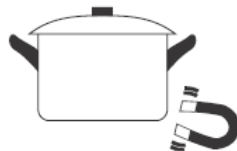

› If you do not have a magnet:

1. Put some water in the pan you want to check.

2. If  does not flash in the display and the water is heating, the pan is suitable.

› Cookware made from the following materials is not suitable: pure stainless steel, aluminium or copper without a magnetic base, glass, wood, porcelain, ceramic, and earthenware.

Do not use cookware with jagged edges or a curved base.



Make sure that the base of your pan is smooth, sits flat against the glass, and is the same size as the cooking zone. Use pans that have a diameter as large as the graphic of the zone selected. Using a pan slightly wider, will mean energy is used at its maximum efficiency. If you use a smaller pan the efficiency could be less than expected. A pan less than the minimum dimensions detailed below could be undetected by the hob.

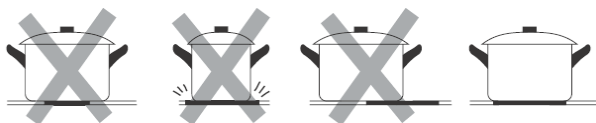

Always lift pans off the induction hob – do not slide them or they may scratch the glass.

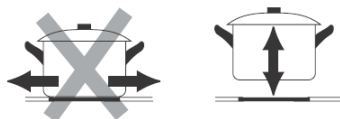

## PAN DIMENSIONS

The cooking zones are, up to a limit, automatically adapted to the diameter of the pan. However the bottom of this pan must have a minimum diameter according to the corresponding cooking zone. To obtain the best efficiency of your hob, please place the pan in the centre of the cooking zone.

COOKING ZONE	MIN. PAN DIAMETER (MM)	MAX. PAN DIAMETER (MM)
1	140	180
2	140	180
3	250	280
4	140	280
5	140	180
6	140	180
7	250	280

# USING YOUR INDUCTION HOB

## TO START COOKING

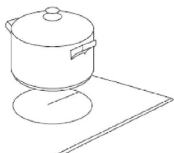
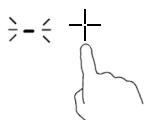
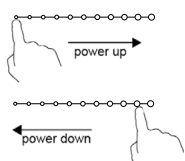



	<p>Touch the ON/OFF control. After power on, the buzzer beeps once, all displays show “-” or “- -”, indicating that the induction hob has entered the state of standby mode.</p>
	<p>Place a suitable pan on the cooking zone that you wish to use. Make sure the bottom of the pan and the surface of the cooking zone are clean and dry.</p>
	<p>Touch the heating zone selection control, and the indicator next to the key will flash.</p>
	<p>Adjust the heat setting by touching the slider control. If you don't choose a heat setting within 1 minute, the induction hob will automatically switch off. You will need to start again at step 1. You can modify the heat setting at any time during cooking.</p>

If the display flashes  alternately with the heat setting this means that:

- › You have not placed a pan on the correct cooking zone.
- › The pan you're using is not suitable for induction cooking.
- › The pan is too small or not properly centred on the cooking zone.

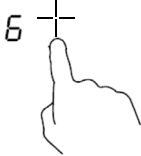
No heating takes place unless there is a suitable pan on the cooking zone. The display will automatically turn off after 2 minutes if no suitable pan is placed on it.

## WHEN YOU HAVE FINISHED COOKING

	<p>Touch the heating zone selection control that you wish to switch off.</p>
	<p>Turn the cooking zone off by moving the slider to "1". Make sure the display shows "0".</p>
	<p>Turn the hob off completely by touching the ON/OFF control.</p>
	<p> <b>Beware of hot surfaces</b></p> <p>'H' will show which cooking zone is hot to touch. It will disappear when the surface has cooled down to a safe temperature. It can also be used as an energy saving function if you want to heat further pans, use the zone that is still hot.</p>

## USING THE BOOST

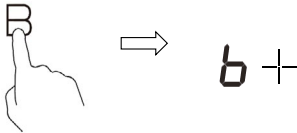
	<p>Touch the heating zone selection control.</p>
	<p>Touch the boost control <b>B</b>, the zone indicator shows 'b' and the power reaches max.</p>

## CANCEL THE BOOST FUNCTION

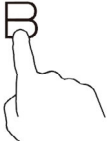
	<p>Touch the heating zone selection control that you wish to cancel the boost function for.</p>
	<p>Touch the boost control <b>B</b>, to cancel the Boost function. The cooking zone will revert to its original setting.</p>

### NOTES:

- › The function can work on all cooking zones.
- › The cooking zone returns to its original setting after 5 minutes.
- › If the original heat setting equals 0, it will return to 9 after 5 minutes.

## BRIDGE FUNCTION

The bridge function allows you to link two smaller zones to make one larger cooking zone.

### ACTIVATE BRIDGE FUNCTION

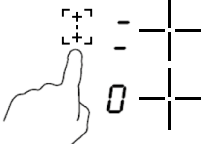
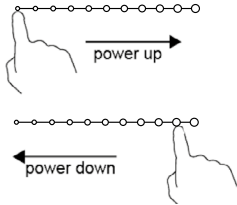
	<p>To activate the Bridge zone area, press the Bridge zone button for the side of the hob you wish to bridge.</p>
	<p>Adjust the heat setting by touching the slider control.</p>

We suggest using cookware 250mm or 280mm in diameter (square or oval cookware are acceptable).

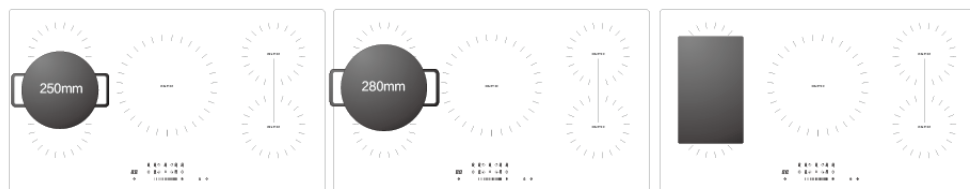



#### NOTE:

Placing cookware alternatively to the suggestions above is not recommended and might effect the heating of the appliance.

## CHILD SAFETY LOCK

- › You can lock the controls to prevent unintended use (for example children accidentally turning the cooking zones on).
- › When the controls are locked, all the controls except the ON/OFF control are disabled. In the event of an emergency, you can always turn the hob off by using the ON/OFF button.

TO LOCK THE CONTROLS	
	Touch the lock control, the timer will then display 'Lo'.
TO UNLOCK THE CONTROLS	
	Make sure the induction hob is turned on. Touch and hold the keylock control for a while. You can now start using your induction hob.

 When the hob is in the lock mode, all the controls are disabled except the ON/OFF button, you can always turn the induction hob off with the ON/OFF control in an emergency, but you will need to unlock the hob first before the next operation.

## OVER-TEMPERATURE PROTECTION

A temperature sensor equipped can monitor the temperature inside the induction hob. When an excessive temperature is monitored, the induction hob will stop operation automatically.

## DETECTION OF SMALL ARTICLES

When an unsuitable size or non-magnetic pan (e.g. aluminium), or some other small item (e.g. knife, fork, key) has been left on the hob, the hob will automatically switch to standby after 1 minute. The fan will keep cooling down the induction hob for a further 1 minute.

## AUTO SHUTDOWN PROTECTION

Auto shut down is a safety protection function for your induction hob. It shuts down automatically if ever you forget to turn off your hob. The default working times for various power levels are shown in the below table:

Power level	1	2	3	4	5	6	7	8	9
Default working timer (hours)	8	8	8	4	4	4	2	2	2

When a pan is removed, the induction hob will stop heating immediately and the hob automatically switches off after 2 minutes.







**WARNING:**

People with a heart pace maker should consult with their doctor before using the hob.



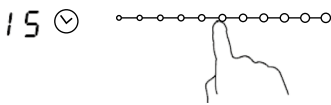

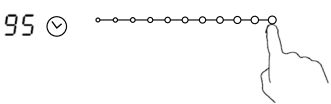

## TIMER CONTROL

You can use the timer in two different ways:



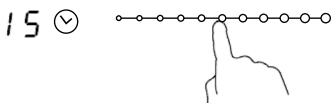

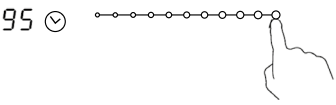
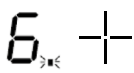
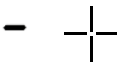

- › You can use it as a minute minder. In this case, the timer will not turn any cooking zone off when the set time is up.
- › You can set it to turn one or more cooking zones off after the set time is up. The timer maximum is 99 minutes.

USING THE TIMER AS A MINUTE MINDER	
	<p>Make sure the hob is turned on and a heating zone is in use.</p> <p>Touch the timer control. The minder indicator will start flashing and "10" will show in the timer display, the "0" will flash.</p>
	<p>Set the time by touching the slider control (e.g. 5).</p>
	<p>Touch the timer control again, the "1" will flash.</p>
	<p>Set the time by touching the slider control (e.g. 9).</p> <p>The timer has now been set to 95 minutes.</p>
	<p>When the time is set, it will begin to count down immediately.</p> <p>The display will show the remaining time and the timer indicator will flash for 5 seconds.</p> <p>The buzzer will sound for 30 seconds and the timer indicator shows "--" when the set time finished.</p>

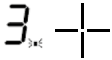
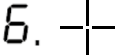
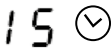



SETTING THE TIMER TO TURN ONE COOKING ZONE OFF

	<p>Touch the heating zone selection control that you want to set the timer for.</p>
	<p>Touch the timer control, "10" will show in the timer display and the "0" will flash.</p>
	<p>Set the time by touching the slider control (e.g.5).</p>
	<p>Touch the timer control again and the "1" will flash.</p>
	<p>Set the time by touching the slider control (e.g.9). The timer will now be set to 95 minutes.</p>
	<p>When the time is set, it will begin to count down immediately. The display will show the remaining time.</p> <p>The red dot next to power level indicator will illuminate indicating that zone is selected.</p>
	<p>When cooking timer expires, the corresponding cooking zone will be switched off automatically.</p> <p> The other cooking zone will keep operating if it was turned on previously.</p>

## SETTING THE TIMER TO TURN MORE THAN ONE COOKING ZONE OFF

<p>(Set to 15 minutes) </p> <p>(Set to 45 minutes) </p> <p> </p>	<p>When you set the time for several cooking zones simultaneously, decimal dots of the relevant cooking zones appear. The minute display shows the minute timer. The dot of the corresponding zone flashes.</p>
<p></p> <p></p> <p> </p>	<p>Once the countdown timer expires, the corresponding zone will switch off. Then it will show the new minute timer and the dot of the corresponding zone will flash.</p> <p>Touch the heating zone selection control and the corresponding timer will be shown in the timer indicator.</p>

## CANCELLING THE TIMER

<p> </p>	<p>Touch the heating zone selection control that you want to cancel the timer for.</p>
<p> </p>	<p>Touch the timer control; the indicator will flash.</p> <p>Touch the slider control to set the timer to "00". The timer is cancelled.</p>

## COOKING GUIDELINES

---



Take care when frying as the oil and fat heat up very quickly, particularly if you're using the Boost function. At extremely high temperatures oil and fat will ignite spontaneously and this presents a serious fire risk.

- › When food comes to the boil, reduce the temperature setting.
- › Using a lid will reduce cooking times and save energy by retaining the heat.
- › Minimise the amount of liquid or fat to reduce cooking times.
- › Start cooking on a high setting and reduce the setting when the food has heated through.

### **SIMMERING**

- › Simmering occurs below boiling point, at around 85°C, when bubbles are just rising occasionally to the surface of the cooking liquid. It is the key to delicious soups and tender stews because the flavours develop without overcooking the food. You should also cook egg-based and flour thickened sauces below boiling point.
- › Some tasks, including cooking rice by the absorption method, may require a setting higher than the lowest setting to ensure the food is cooked properly in the time recommended.

### **SEARING STEAK**

To cook juicy flavoursome steaks:

1. Stand the meat at room temperature for about 20 minutes before cooking.
2. Heat up a heavy-based frying pan.
3. Brush both sides of the steak with oil. Drizzle a small amount of oil into the hot pan and then lower the meat onto the hot pan.
4. Turn the steak only once during cooking. The exact cooking time will depend on the thickness of the steak and how cooked you want it. Times may vary from about 2– 8 minutes per side. Press the steak to gauge how cooked it is – the firmer it feels the more 'well done' it will be.
5. Leave the steak to rest on a warm plate for a few minutes to allow it to relax and become tender before serving.

## **STIR-FRYING**

1. Choose an induction compatible flat-based wok or a large frying pan.
2. Have all the ingredients and equipment ready. Stir-frying should be quick. If cooking large quantities, cook the food in several smaller batches.
3. Preheat the pan briefly and add two tablespoons of oil.
4. Cook any meat first, put it aside and keep warm.
5. Stir-fry the vegetables. When they are hot but still crisp, turn the cooking zone to a lower setting, return the meat to the pan and add your sauce.
6. Stir the ingredients gently to make sure they are heated through.
7. Serve immediately.

## **DETECTION OF SMALL ARTICLES**

When an unsuitable size or non-magnetic pan (e.g. aluminium), or small items (e.g. knife, fork, key) has been left on the hob, the hob will automatically go on to standby in 1 minute. The fan will keep cooking down the induction hob for a further 1 minute.

## HEAT SETTINGS

The settings below are guidelines only. The exact setting will depend on several factors, including your cookware and the amount you are cooking. Experiment with the induction hob to find the settings that best suit you.

HEAT SETTING	SUITABILITY
1 - 2	Delicate warming for small amounts of food. Melting chocolate, butter, and foods that burn quickly. Gentle simmering. Slow warming.
3 - 4	Reheating. Rapid simmering. Cooking rice.
5 - 6	Pancakes.
7 - 8	Sautéing. Cooking pasta.
9	Stir-frying. Searing. Bringing soup to the boil. Boiling water.

# INSTALLATION

## SELECTION OF INSTALLATION EQUIPMENT

Cut out the work surface according to the sizes shown in the drawing. For the purpose of installation and use, a minimum of 50mm space shall be preserved around the hole. Be sure the thickness of the work surface is at least 30mm. Please select heat-resistant work surface material to avoid larger deformation caused by the heat radiation from the hob. As shown below:

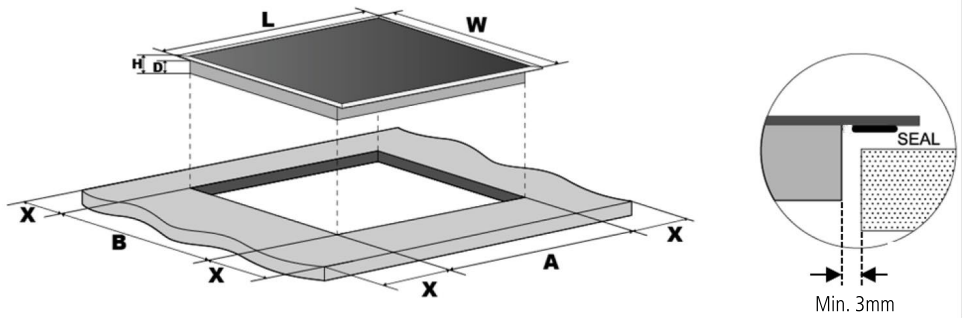

L (mm)	W (mm)	H (mm)	D (mm)	A (mm)	B (mm)	X (mm)
900	520	60	56	874	494	50

## VENTILATION REQUIREMENTS

To ensure adequate ventilation of your induction hob, please ensure the installation requirements shown in this diagram are followed.

A 5mm gap at the front of the unit must be left, and a minimum 10mm gap must be cut out at the back of the cabinet to allow air to circulate.

A minimum distance of 50mm must be left between the underside of the hob and the appliance directly below. If a drawer is installed below the hob, a minimum distance of 50mm must be left between the underside of the hob, and the contents of the drawer.

Over filling the drawer may effect the airflow. If the drawer is overfilled or the ventilation requirements not followed, this will void the guarantee.



### NOTE:

The safety distance between the hotplate and cupboard above the hotplate should be at least 600mm.

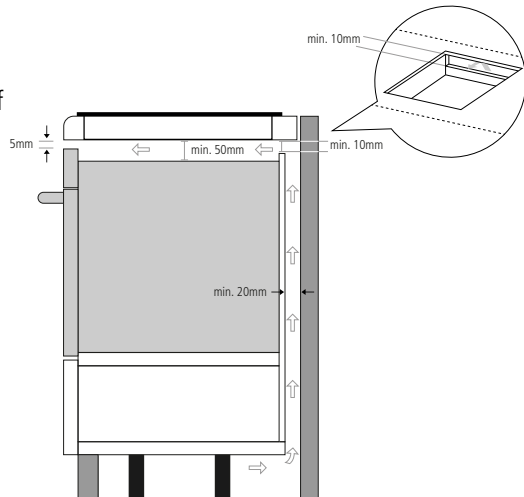

The panels of the adjoining furniture should be heat resistant. Particularly when the adjoining furniture is made of veneered wood, the adhesives should be able to withstand a temperature of 150°C. Plastic materials or adhesive which cannot withstand this temperature may become deformed or unstuck.



There are ventilation holes around the outside of the hob. YOU MUST ensure these holes are not blocked by the worktop when you place the hob in position.

The rear wall, adjacent and surrounding surfaces must be able to withstand an temperature of 90°C.

## **BEFORE INSTALLING THE HOB, MAKE SURE THAT:**

- › The induction hob must be installed by qualified personnel or Caple technicians. Please never conduct the installation yourself.
- › Check the work surface is square and level, and no structural members interfere with space requirements.
- › Check the work surface is made of a heat-resistant material.
- › If the hob is installed above an oven, the oven has a built-in cooling fan.
- › The installation will comply with all clearance requirements and applicable standards and regulations.
- › Ensure a suitable isolating switch providing full disconnection from the mains power supply is incorporated in the permanent wiring, mounted and positioned to comply with the local wiring rules and regulations.
- › The isolating switch must be of an approved type and provide a 3mm air gap contact separation in all poles (or in all active [phase] conductors if the local wiring rules allow for this variation of the requirements).
- › The isolating switch will be easily accessible to the customer once the hob is installed.
- › You consult local building authorities and by-laws if in doubt regarding installation.
- › You use heat-resistant and easy-to-clean finishes (such as ceramic tiles) for the wall surfaces.

## **AFTER INSTALLING THE HOB, MAKE SURE THAT:**

- › Ensure the power supply cable is not accessible through cupboard doors or drawers.
- › Ensure there is adequate flow of fresh air from outside the cabinetry to the base of the hob.
- › If the hob is installed above a drawer or cupboard space, a thermal protection barrier is installed below the base of the hob.
- › The isolating switch must be easily accessible by the customer.

## **BEFORE LOCATING THE FIXING BRACKETS**

- › The unit should be placed on a stable, smooth surface (use the packaging).
- › Do not apply force onto the controls protruding from the hob.

## ADJUSTING THE BRACKET POSITION

Fix the hob on the work surface by screwing 2 brackets on the bottom of hob (see picture) after installation. Adjust the bracket position to suit for different worktop thickness.

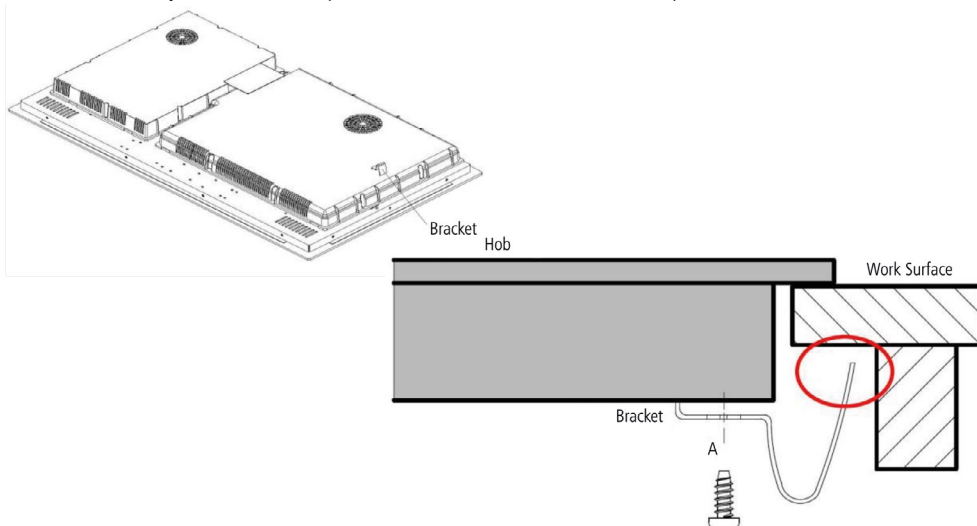

**!** Under any circumstances, the brackets cannot touch with the inner surfaces of the worktop after installation (see picture). This will ensure the hob is properly secured to the underside of the work surface.

### CAUTIONS:

- › The hob should not be installed directly above a dishwasher, fridge, freezer, washing machine or clothes dryer, as the humidity may damage the hob electronics.
- › The wall and induced heating zone above the table surface should be able to withstand heat.
- › To avoid any damage, the worktop sandwich layer and adhesive must be heat resistant.

## CONNECTING THE HOB TO THE MAINS POWER SUPPLY

### **!** WARNING:

- › This hob must be connected to the mains power supply only by a suitably qualified person.
- › Before connecting the hob to the mains power supply, check that:
  1. The domestic wiring system is suitable for the power drawn by the hob.

2. The voltage corresponds to the value given in the rating plate.
  3. The power supply cable sections can withstand the load specified on the rating plate.
- › To connect the hob to the mains power supply, do not use adapters, reducers, or branching devices, as they can cause overheating and fire.
  - › The power supply cable must not touch any hot parts and must be positioned so that its temperature will not exceed 75°C at any point.
  - › Check with an electrician whether the domestic wiring system is suitable without alterations. Any alterations must only be made by a qualified electrician.

The power supply should be connected in compliance with the relevant standard, or a single-pole circuit breaker. The method of connection is shown below:

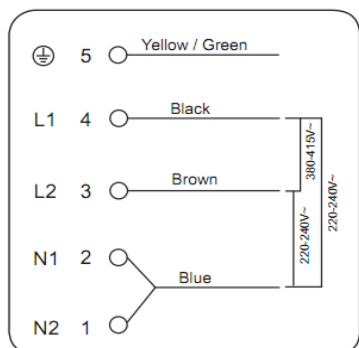

- › If the cable is damaged or needs replacing the operation must be carried out by a Cable service engineer.
- › If the appliance is being connected directly to the mains an omnipolar circuit breaker must be installed with a minimum opening of 3mm between contacts.
- › The installer must ensure that the correct electrical connection has been made and that it is compliant with safety regulations.
- › The cable must not be bent or compressed.
- › The cable must be checked regularly and replaced by authorised technicians only.



**NOTE:**

The bottom surface and the power cord of the hob are not accessible after installation.

## CARE AND MAINTENANCE

WHAT?	HOW?	IMPORTANT
<p>Everyday soiling on glass (fingerprints, marks, stains left by food or non-sugary spills on the glass).</p>	<ol style="list-style-type: none"> <li>1. Switch the power to the hob off.</li> <li>2. Apply a hob cleaner while the glass is still warm (but not hot).</li> <li>3. Rinse and wipe dry with a clean cloth or paper towel.</li> <li>4. Switch the power to the hob back on.</li> </ol>	<p>When the power to the hob is switched off, there will be no 'hot surface' indication but the cooking zone may still be hot. Take extreme care.</p> <p>Heavy-duty scourers, some nylon scourers and harsh/abrasive cleaning agents may scratch the glass. Always read the label to check if your cleaner or scourer is suitable.</p> <p>Never leave cleaning residue on the hob: the glass may become stained.</p>
<p>Boil-overs, melts, and hot sugary spills on the glass.</p>	<p>Remove these immediately with a fish slice, palette knife or razor blade scraper suitable for Induction glass hobs, but beware of hot cooking zone surfaces:</p> <ol style="list-style-type: none"> <li>1. Switch the power to the hob off at the wall.</li> <li>2. Hold the blade or utensil at a 30° angle and scrape the soiling or spill to a cool area of the hob.</li> <li>3. Clean the soiling or spill up with a dish cloth or paper towel.</li> <li>4. Follow steps 2 to 4 for 'Everyday soiling on glass' above.</li> </ol>	<p>Remove stains left by melts and sugary food or spillovers as soon as possible. If left to cool on the glass, they may be difficult to remove or even permanently damage the glass surface.</p> <p>Cut hazard: when the safety cover is retracted, the blade in a scraper is razor-sharp. Use with extreme care and always store safely and out of reach of children.</p>
<p>Spills on the touch controls.</p>	<ol style="list-style-type: none"> <li>1. Switch the power to the hob off.</li> <li>2. Soak up the spill.</li> <li>3. Wipe the touch control area with a clean damp sponge or cloth.</li> <li>4. Wipe the area completely dry with a paper towel.</li> <li>5. Switch the power to the hob back on.</li> </ol>	<p>The hob may beep and turn itself off, and the touch controls may not function while there is liquid on them. Make sure you wipe the touch control area dry before turning the hob back on.</p>

## TROUBLESHOOTING

PROBLEM	POSSIBLE CAUSES	WHAT TO DO
The induction hob cannot be turned on.	No power.	Make sure the induction hob is connected to the power supply and that it is switched on. Check whether there is a power outage in your home or area. If you've checked everything and the problem persists, call a qualified technician.
The touch controls are unresponsive.	The controls are locked.	Unlock the controls. See section 'Using your induction hob' for instructions.
The touch controls are difficult to operate.	There may be a slight film of water over the controls or you may be using the tip of your finger when touching the controls.	Make sure the touch control area is dry and use the ball of your finger when touching the controls.
The glass is being scratched.	Rough-edged cookware. Unsuitable, abrasive scourer or cleaning products being used.	Use cookware with flat and smooth bases. See 'Choosing the right cookware'. See 'Care and Maintenance'.
Some pans make crackling or clicking noises.	This may be caused by the construction of your cookware (layers of different metals vibrating differently).	This is normal for cookware and does not indicate a fault.
The induction hob makes a low humming noise when used on a high heat setting.	This is caused by the technology of induction cooking.	This is normal, but the noise should quieten down or disappear completely when you decrease the heat setting.
Fan noise coming from the induction hob.	A cooling fan built into your induction hob has come on to prevent the electronics from overheating. It may continue to run even after you've turned the induction hob off.	This is normal and needs no action. Do not switch the power to the induction hob off at the wall while the fan is running.
Pans do not become hot and appears in the display.	The induction hob cannot detect the pan because it is not suitable for induction cooking. The induction hob cannot detect the pan because it is too small for the cooking zone or not properly centred on it.	Use cookware suitable for induction cooking. See section 'Choosing the right cookware'. Centre the pan and make sure that its base matches the size of the cooking zone.
The induction hob or a cooking zone has turned itself off unexpectedly, a tone sounds and an error code is displayed (typically alternating with one or two digits in the cooking timer display).	Technical fault.	Please note down the error letters and numbers, switch the power to the induction hob off at the wall, and contact Caple Service on 0117 938 1900.

## FAILURE DISPLAY ERROR CODES

---

The induction hob is equipped with a self diagnostic function. With this test the technician is able to check the function of several components without disassembling or dismantling the hob from the working surface.

PROBLEM	POSSIBLE CAUSES	WHAT TO DO
F3-F8	Temperature sensor failure.	Please contact Caple service
F9-FE	Temperature sensor of the IGBT failure.	Please contact Caple service
E1/E2	Abnormal supply voltage	Please inspect whether power supply is normal. Power on after the power supply is normal.
E3/E4	Temperature sensor of the ceramic glass plate is high	Please restart after the induction hob cools down.
E5/E6	Temperature sensor of the IGBT is high	Please restart after the induction hob cools down.

The above are the judgment and inspection of common failures.

Please do not disassemble the unit by yourself to avoid any dangers and damages to the induction hob. Caple Service can be contacted by telephone on 0117 938 1900.

## TECHNICAL SPECIFICATION

---

MODEL CODE	C8971
Cooking zones	5 Zones
Supply voltage	220-240V~ 50/60Hz
Installed electric power	9400 W
Product size LxWxH (mm)	900 X 520 X 60
Building in dimensions AxB (mm)	874 X 494

Weight and dimensions are approximate. We continually strive to improve our products therefore we may change specifications and designs without prior notice.



Caple Service  
Fourth Way  
Avonmouth  
Bristol  
BS11 8DW

T: 0117 938 1900  
E: [service@caple.co.uk](mailto:service@caple.co.uk)  
[www.caple.co.uk](http://www.caple.co.uk)