



Sense Premium, Combination
Microwave with Steam
Instruction Manual

CMS260



Contact Caple on 0117 938 7420 for spare parts or www.caple.co.uk

CONTENTS

Safety Warnings	4
Environmental Protection	15
Warranty	16
Installation	17
Dimensions	20
Electrical Connection	21
Control Panel and Display	23
Operation	24
Settings Menu	49
Functions	54
Special Functions	56
Care and Maintenance	64
Accessories	66
CapleHome App	70
Troubleshooting	77
Error Codes	79
Caple Contact Details	80

Welcome to your new Sense Premium Combination Microwave with Steam.

Featuring our new CapleTouch+ Technology, you'll be able to save your family favourites, set multi-stage cooking timers and customise with ease.

To control your appliance from your smart phone or tablet, download the CapleHome App  from www.caple.co.uk or the relevant app store for your device.

SAFETY INSTRUCTIONS:

Read these instructions carefully and completely before using your appliance. They provide you with important information regarding the safe installation, use and maintenance of the appliance as well as useful advice for getting the best out of your microwave oven. Keep this booklet in a safe place for future reference and pass on to any future owner.

INSTALLATION WARNINGS:

- This appliance is produced in accordance with all applicable local and international standards and regulations.
- The microwave oven is intended for heating food and beverages. Drying of food or clothing and heating of warming pads, slippers, sponges, damp cloth and similar may lead to risk of injury, ignition or fire.
- The microwave oven is not intended for outdoor use.
- This appliance is intended to be used in household and similar applications such as:
 - › Staff kitchen areas in shops, offices and other working environments.
 - › Farm Houses.
 - › By clients in hotels, motels and other residential type environments.
 - › Bed and breakfast type environments.
- Do not try to lift or move the appliance by pulling the door handle.

- This appliance may only be used by persons (including children) with reduced physical, sensory or mental capabilities, or lack of experience and knowledge, if they are supervised whilst using it. They may only use it unsupervised if they have been shown how to use it in a safe manner. They must be able to recognise and understand the dangers of misuse.

SAFETY WITH CHILDREN:

- This appliance can be used by children aged from 8 years and above and persons with reduced physical, sensory or mental capabilities or lack of experience and knowledge if they have been given supervision or instruction concerning use of the appliance in a safe way and understand the hazards involved.
- Children less than 8 years of age should be kept away unless continuously supervised or they have been shown how to use it in a safe manner. Children must be able to understand and recognise the possible dangers caused by incorrect operation.
- Children should be supervised in the vicinity of the appliance. Never allow children to play with the appliance.
- Cleaning and user maintenance should not be carried out by children without supervision.
- External parts of the oven such as the door glass, control panel and the vent become hot. Do not let children touch the oven when it is in operation, particularly when the grill is in use.

- Materials used for packaging (plastic sheeting, nylon, staplers, Styrofoam etc.) may cause harmful effects to children, they should be disposed of immediately.
- Children can injure themselves on an open door. Do not let children sit on the open door, lean against it or swing on it.

TECHNICAL SAFETY:

- Maintenance and repair work must be made only by authorised Caple service technicians. Installation and repair work that is carried out by unauthorised technicians may endanger you.
- It is hazardous for anyone other than a competent person to carry out any service or repair operation that involves the removal of a cover which gives protection against exposure to microwave energy.
- While the oven is under warranty, repairs should only be undertaken by a Caple authorised service technician, otherwise the warranty will be invalidated
- It is dangerous to alter or modify the specifications of the appliance in any way. The requirements for this appliance are stated on the rating label.
- Risk of injury due to electric shock. Any contact with live connections or tampering with the electrical or mechanical components of the appliance will endanger your safety and may lead to the appliance malfunctioning. Do not open the appliance housing under any circumstances.

- To maintain the efficiency and safety of your appliance, we recommend you always use original spare parts and to call only our authorised Caple Service agents in case of need.
- Multi-socket adapters and extension leads should not be used to connect the appliance to the mains electricity supply.
- The electrical system of this appliance may be used safely only when it is correctly connected to an efficient earthing system in compliance with the safety standards currently in effect.

INSTALLATION WARNINGS:

- Prior to installation, ensure that the local distribution conditions (electricity voltage and frequency) and the requirements of the appliance are compatible.
- During installation the oven must be completely disconnected from the mains electricity supply.
- Do not operate the appliance before it is fully installed.
- The appliance must be installed by an authorised technician.
- Caple is not responsible for any damage that may be caused by defective placement and installation by unauthorised persons.
- Before use, remove all plastic films protecting some parts of the appliance (fascia - panel, parts in stainless steel, etc.).

- To reduce the risk of burns, electric shock, fire, injury to persons or exposure to excessive microwave energy, make sure that all the packing materials are removed from the inside of the door.
- When unpacking the appliance, make sure that it is not damaged during transportation.
- Check the appliance for any damage, such as misaligned or bent door, damaged door seals and sealing surface, broken or loose door hinges and latches and dents inside the cavity or on the door.
- In the case of any defect; do not use the appliance and contact your retailer or Caple Service immediately.
- Ensure that the supply cord is not wedged during the installation.
- Do not operate this appliance if it has a damaged cord or plug, if it is not working properly or if it has been damaged or dropped. If the supply cord is damaged, it must be replaced by a Caple service technician or similarly qualified persons in order to prevent a hazard.
- Protect your appliance against atmospheric effects. Do not expose it to effects such as sun, rain, snow etc.
- This microwave oven must be placed on a flat, stable surface to hold its weight and the heaviest food likely to be cooked in the oven.
- Do not place the microwave oven where heat, moisture, or high humidity are generated, or near combustible materials.

- The surrounding materials of the appliance (i.e. kitchen cabinet or furniture) must be able to withstand a minimum temperature of 120°C.

DURING USE:

- Before using for the first time, heat the empty appliance at max. temperature for 1 hour on Fan Heat-removing any unpleasant smells and smoke caused by working residues and thermal insulation. Make sure you do this in a well-ventilated area.
- Do not operate the appliance on any microwave function when empty.
- Do not open the oven door immediately after cooking end to avoid scald by the steam.
- While opening the appliance door, step back to avoid the hot steam coming out of the cavity as there may be a risk of burns.
- Do not put flammable or combustible materials in or near the appliance when it is operating.
- During use, handles can get hot.
- The appliance and its accessible parts become hot during use. Care should be taken to avoid touching heating elements.
- Always use oven gloves to remove and replace food in the oven, or to adjust oven shelves if the oven compartment is hot.

- Liquids and other foods must not be heated in sealed containers since they are liable to explode. Only use plastic containers that are suitable for use in microwave ovens.
- Only use utensils that are suitable for use in microwave ovens.
- When heating food in plastic or paper containers, check the oven frequently for the possibility of ignition.
- Pay close attention to the appliance while cooking with solid or liquid oils as they could potentially catch fire when oven is hot.
- Microwave heating of liquids can result in delayed eruptive boiling, therefore care has to be taken when handling the container.
- Do not fry food in the microwave oven. Hot oil can damage oven parts and utensils and even result in skin burns.
- Eggs in their shell and whole hard-boiled eggs should not be heated in microwave ovens since they may explode even after microwave heating has ended.
- Pierce foods with heavy skins such as potatoes, whole squashes, apples and chestnuts before cooking.
- The contents of feeding bottles and baby jars should be stirred or shaken and the temperature should be checked before serving in order to avoid burns.
- Never pour water on flames that are caused by oil. Cover the saucepan or frying pan with its lid in order to choke the flame and turn the oven off.
- Never roast or bake on the oven base.

- If you know you will not be using the appliance for a while, switch it off and isolate it from the electrical supply.
- The appliance shelves and trays incline when pulled out. Be careful not to let hot liquid spill over.
- When the door of the appliance is open, do not leave anything on it. It may unbalance your appliance or damage the door.
- Make sure that nothing gets trapped between the door and the appliance compartment.
- Do not put anything heavy, flammable or ignitable (nylon, plastic bag, paper or cloth etc) into the microwave oven. This includes cookware with plastic accessories (e.g. handles).
- Remove wire ties from paper or plastic bags before placing bag in microwave oven.
- Do not hang towels, dishcloths or clothes from the appliance or its handles.
- To avoid fire hazards, do not use the oven for storage purposes.
- Do not leave paper products, cooking utensils or food in the cavity when not in use.
- Do not touch the appliance with wet hands.
- Do not obstruct the ventilation openings.
- Do not allow supply cords from other small appliances to come into contact with the oven.
- Do not use the appliance to heat a room.

- Do not place magnets on the oven door. Magnets can scratch the surface as well as damage your oven.
- The oven compartment floor can become damaged by items being pushed around. Ensure pots, pans and crockery are carefully placed in the oven.
- If smoke is observed. Switch off or unplug the appliance and keep the door closed in order to stifle any flames.
- When the appliance is not in use, we recommend you turn it off, and isolate it from the electrical supply.
- The appliance is not intended to be operated by means of an external timer or separate remote-control system.
- The manufacturer will not be held liable for any damages that might arise out of incorrect or improper use of the appliance.

CLEANING AND MAINTENANCE:

- Always switch off the appliance from the mains isolating the electrical supply before any cleaning or maintenance.
- The oven should be cleaned regularly and any food deposits removed.
- All possible security measures have been taken to ensure your safety. Since the glass may break, you should be careful while cleaning to avoid scratching.
- Do not use harsh abrasive cleaners or sharp metal scrapers to clean the oven door glass or any other

surface of the appliance as it can scratch the surface which may result in the glass shattering or permanent damage to the surface.

- Do not use steam cleaners for cleaning the appliance.
- Ensure the appliance is switched off before replacing the lamp to avoid the possibility of electric shock.
- Failure to maintain the oven in a clean condition could lead to deterioration of the surface that could adversely affect the life of the appliance and possibly result in a hazardous situation.

ACCESSORIES:

- Avoid hitting or knocking the door glass with accessories.
- Do not use the wire shelf with any microwave function. This could damage the shelf or even your microwave oven. The wire shelf is for normal convection/Fan cooking or grilling only.
- Do not use the glass tray on or under a flame or other direct heat source.
- Do not drop or hit the tray against hard objects or strike utensils against it.
- Handle the glass tray with care to prevent breakage, chipping, cracking or severe scratching. Do not use or repair the tray if it is chipped, cracked or severely scratched.
- Avoid sudden changes in temperature to the glass tray.
- Do not use the Grill Rack supplied with the glass tray with any microwave function. This could damage the rack or even your microwave oven. The wire rack is for normal convection/Fan cooking or grilling only.

ENVIRONMENTAL PROTECTION



Waste electrical products should not be disposed of with household waste. Please recycle where facilities exist. Check with your Local Authority or retailer for recycling advice. This appliance is marked according to the European directive on Waste Electrical and Electronic Equipment (WEEE).

By ensuring this product is disposed of correctly, you will help prevent potential negative consequences for the environment and human health, which could otherwise be caused by inappropriate waste handling of this product. The symbol on the product indicates that this product may not be treated as household waste. Instead it shall be handed over to the applicable collection point for the recycling of electrical and electronic equipment. Disposal must be carried out in accordance with local environmental regulations for waste disposal.

For more detailed information about treatment, recovery and recycling of this product, please contact your local council, your household waste disposal service or the retailer where you purchased the product.

CE DECLARATIONS OF CONFORMITY



Radio Equipment Directive (RED) 2014/53/EU

This Declaration is issued under the sole responsibility of the manufacturer.

Hereby, Caple declares that the radio equipment included in the product is in compliance with the RED directive 2014/53/EU.

The full text of the EU Declaration of Conformity is available on our website www.caple.co.uk.

UKCA DECLARATIONS OF CONFORMITY



This appliance has been manufactured to the strictest standards and complies with all applicable legislation.

TECHNICAL FICHE

This appliance conforms to all current and applicable energy regulations. To view the Technical Fiche that supports the energy labelling data, please visit the product page on our website www.caple.co.uk

WARRANTY:

Your new appliance is covered by warranty. The warranty card is enclosed - if it is missing, you must provide the following information to your retailer in order to receive a replacement: date of purchase, model and serial number (found inside the door opening). Registration can also be completed online by visiting www.caple.co.uk.

Ensure you keep your warranty card safe, you may need to show it to Caple Service together with proof of purchase.

If you fail to show your warranty card you will incur all repair charges.

Spare parts are only available from Caple Service and spare parts authorised centres.

TECHNICAL	
Rated Voltage	220-240V
Rated frequency	50Hz
Power	3050W
WiFi Band	2.4Ghz
Microwave Power	1000W

INSTALLATION

IMPORTANT:

Isolate your appliance from the electrical supply before performing installation or maintenance.

- › Installation should be carried out according to the instructions by a professionally qualified person only.
- › The manufacturer declines all responsibility for any damage to persons, animals or materials due to incorrect installation.
- › The appliance requires a sufficient supply of cool air for efficient operation. Make sure that the supply of cool air is not hindered in any way (e.g. by fitting heat insulation strips in the cabinet carcass). Furthermore, the required supply of cool air must not be excessively heated by other heat sources.

FITTING THE APPLIANCE

Fit the appliance into its surround (beneath a worktop or in an appliance tall housing) by inserting screws and plastic covers into the 2 holes (A – fig.1) that can be seen in the frame of the appliance when the door is open. The screws should then be fixed into the kitchen carcass.

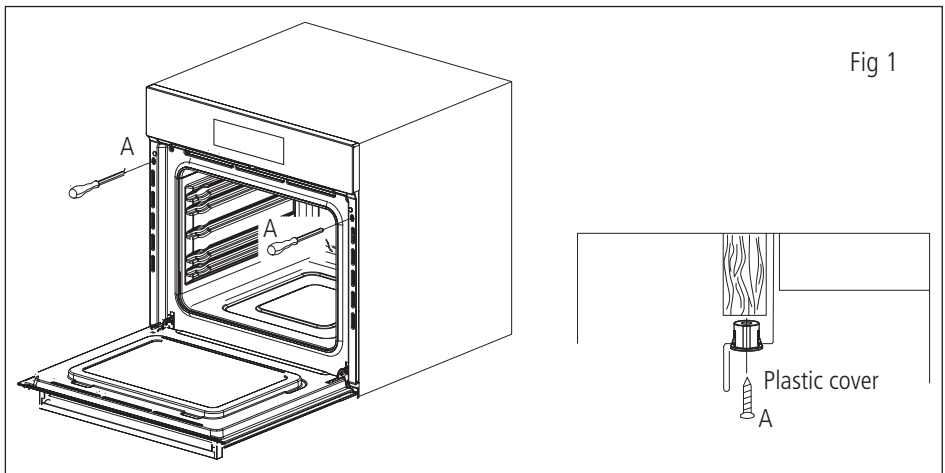

For the most efficient air circulation, the oven should be fitted according to the dimensions shown below:

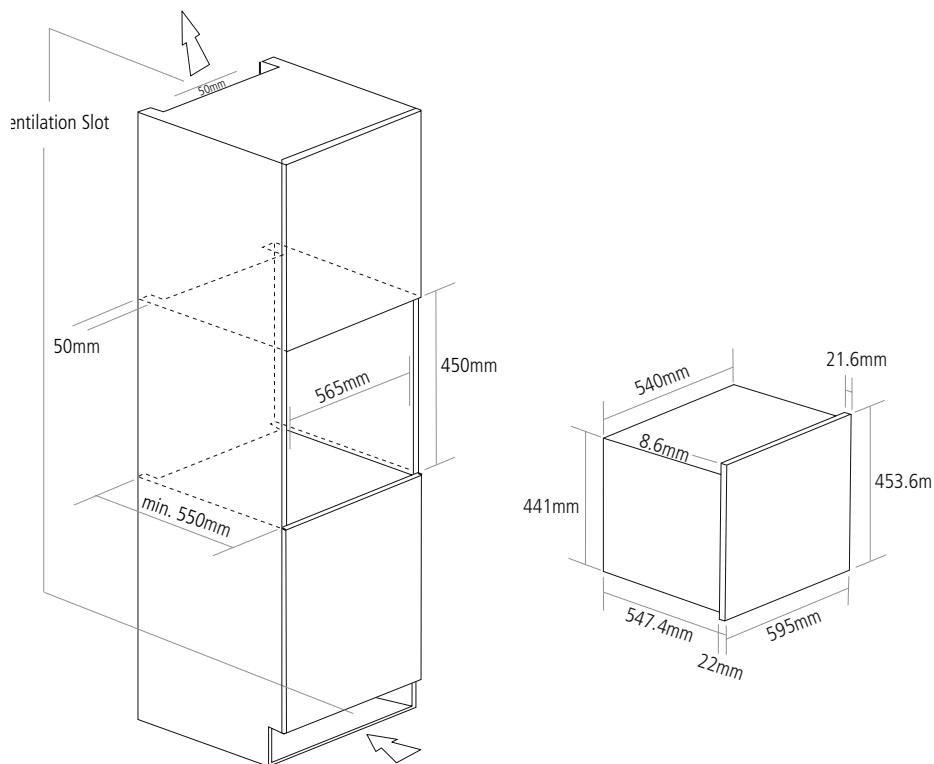

NOTE:

To aid ventilation, we suggest leaving a small gap of around 3mm between the top of the plinth and underside of the cabinet to allow fresh air to circulate around the oven.

The rear panel of the cabinet must be removed so that air can circulate freely. The panel to which the oven is fitted should have a gap of at least 50mm at the rear for ventilation:

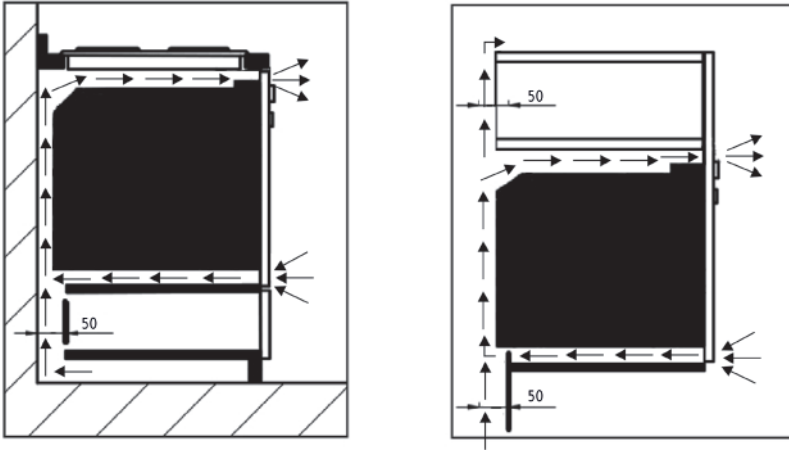

See page 20 for full dimensional drawings of your oven to help with installation.

For a built-in microwave oven to work well, the cabinet must be of the right type.

The panels of the adjoining furniture should be heat resistant. Particularly when the adjoining furniture is made of veneered wood, the adhesives should be able to withstand a temperature of 120°C. Plastic materials or adhesive which cannot withstand this temperature may become deformed or unstuck.

To comply with safety regulations, once the appliance has been fitted it should not be possible to make contact with the electrical parts.

All parts which offer protection should be fixed in such a way that they cannot be removed with the use of a tool.



DIMENSIONS

FRONT

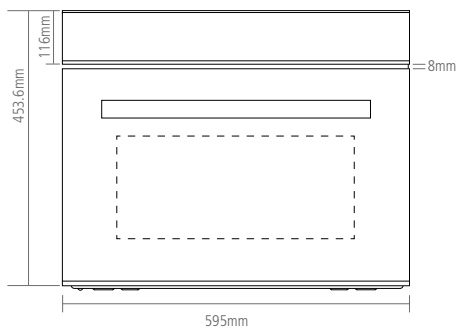

SIDE

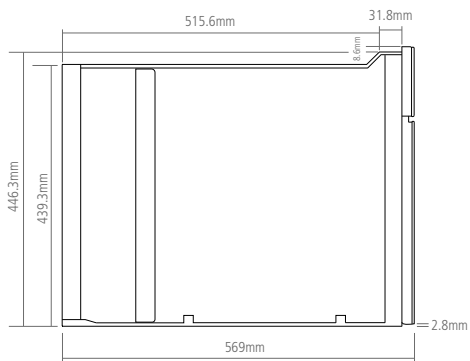

BACK

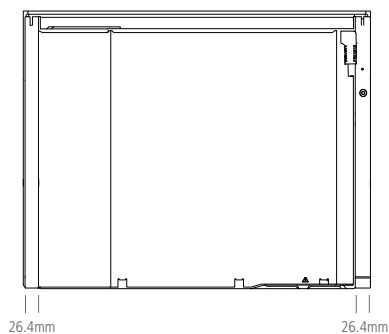

ELECTRICAL CONNECTION

WARNING:

This appliance must be earthed.

Check that the power rating of the mains supply is suitable for the maximum power of the appliance as indicated on the rating label. The fuse rating for this appliance is 16amp. The appliance is supplied with a mains lead it should be "Hard wired" as follows:

- › The "yellow/green" earth wire, which must be connected to a terminal, and has to be about 10mm longer than the other wire.
- › The neutral wire has to be connected to the terminal marked with a letter N.
- › The Live wire should only be connected to the terminal marked L.

Mains connection can also be made by fitting a double pole switch with a minimum gap between the contacts of 3mm, proportionate to the load and complying with the regulations in force.

WARNING:

The yellow/green earth wire should not be controlled by the switch.

When a double pole switch is used for mains supply connection it should be easily accessed, once the appliance is in position.

IMPORTANT:

The mains supply cable should be positioned so that it is never subjected to temperatures which are more than 50°C above ambient temperature.

The electrical safety of the appliance can only be guaranteed when it has been correctly connected to a properly earthed mains electrical supply, as laid down in the current regulations for electrical safety.

The manufacturer cannot be held responsible for any damage to persons or objects due to lack of an earth connection.

The ovens are designed to operate with a mono-phase alternating current of 220-240V, 50Hz.

BEFORE THE INSTALLATION OF THE APPLIANCE, CHECK THE SPECIFICATIONS ON THE RATING LABEL.

CONTROL PANEL AND DISPLAY

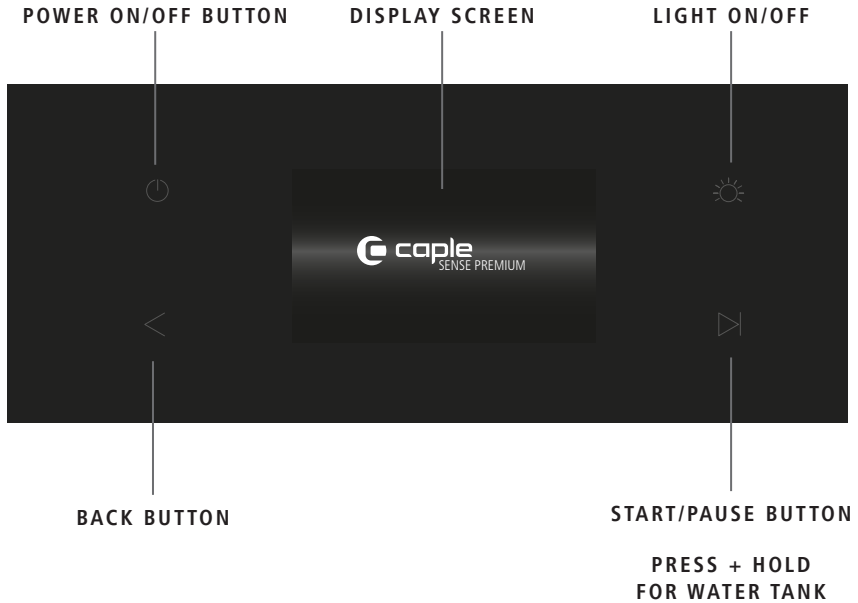

ACCESSORIES

2 x Side Racks

1 x Safety Stop Shelf

1 x Glass Tray

1 x Grill Rack for Glass Tray

1 x Glass Base Plate

1 x Steam Tray

1 x Cleaning Sponge

1 x Water Absorber

To purchase additional or replacement accessories, please visit www.caple.co.uk

OPERATION

POWER BUTTON:

To turn the display screen On and Off.

NOTE:

Turning Off will take you to the standby screen.

LIGHT BUTTON:

Press this button to switch the internal oven lights on and off.

Press and hold for 5 seconds to activate/deactivate Child Safety Lock.

NOTE:

The light will turn itself off after 10 minutes of inactivity.

BACK BUTTON:

Press to return to the previous screen on the display.

Press to cancel cooking.

START/PAUSE / WATER TANK BUTTON:

After turning the oven on, select your desired cooking programme and duration and press  to start cooking.

Press  while the appliance is in operation to pause cooking.

NOTE:

Pause feature only available during Single Stage Cooking, multi-stage cooking cannot be paused.

Press and hold this button to access the Water Tank.

NAVIGATING THE TOUCH CONTROL DISPLAY:

To adjust Times, Dates, Temperatures and Functions etc., press the up and down arrow controls or scroll by pressing and dragging up and down.

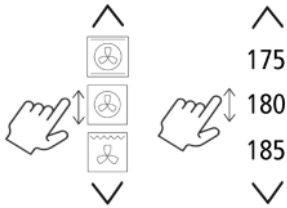

TIP: When adjusting temperatures and times, press and hold ∇ or \blacktriangle to scroll quickly.

USING FOR THE FIRST TIME

1. Press  to turn the appliance on.

When turning the appliance on for the first time you will be asked to set the date and time.

NOTE:

All other menu items cannot be selected at this point.

2. Adjust the Time before pressing

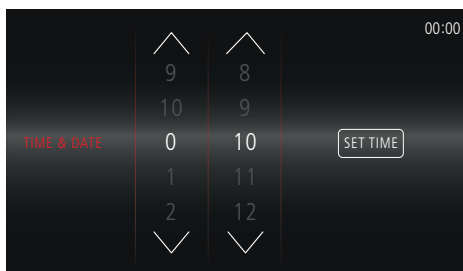

3. Adjust the Date before pressing

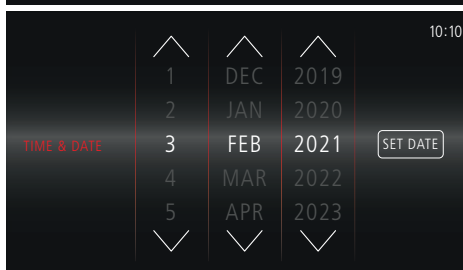

4. Select whether you want the Time and Date to display on the Standby Screen.

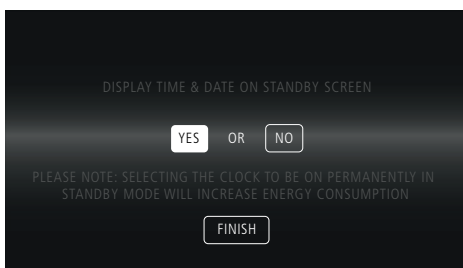

PLEASE NOTE:

Selecting to have the clock on permanently in standby mode will increase Energy consumption. If **Yes** is selected, the default clock display will be analogue mode. This can be changed later in the **Settings Menu**.

5. To complete setup, press

QUICKSTART MICROWAVE COOKING GUIDE

To quickly start cooking without setting a timer and cooking stage or saving to favourites, proceed as follows:

1. Press  to turn the appliance on. The home screen will appear.

The microwave oven is automatically set to Microwave Function at 100%.

To start cooking press 

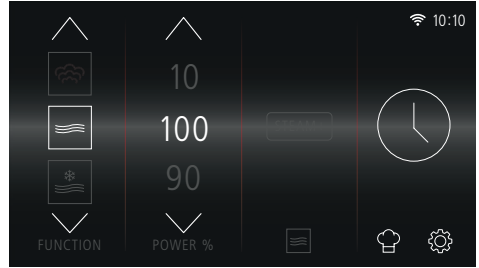

2. The timer will automatically count down from 30 seconds.

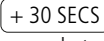
Each press of  adds an additional 30 seconds to the timer.

The timer will count down from the new set time.

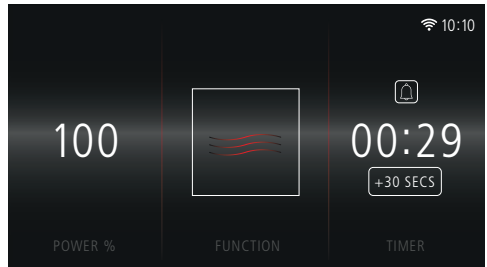

SETTING COOKING STAGES AND SAVING TO FAVOURITES

ONE COOKING STAGE:

1. Press  to turn the appliance on.
2. Select desired Function, Temperature/Power, Steam+ (if required).

Then press 

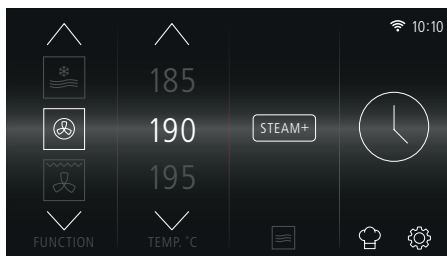

3. Select a Cooking Duration and End Time.

NOTE:

Microwave Function cooking duration is shown in minutes and seconds 'mins:secs'.

End Time will automatically adjust once Duration is set.

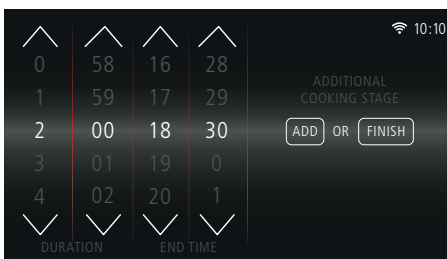

If only one cooking stage is required press

4. Review selection, press to change selection. Press  to begin cooking without saving or press to store in your favourite's menu.

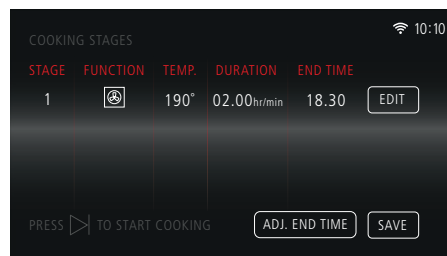

5. If saving to favourites, name your selection and press . If required, press to amend your selection name, or press to store in your favourites.

NOTE:

Selection names are limited to 14 characters.

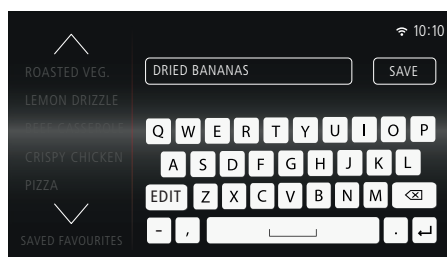

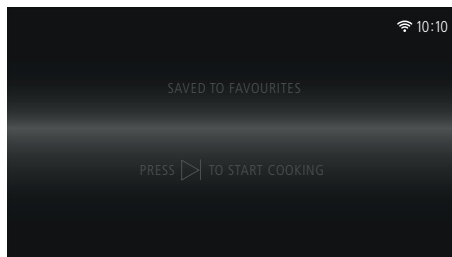

6. Press  to begin cooking.

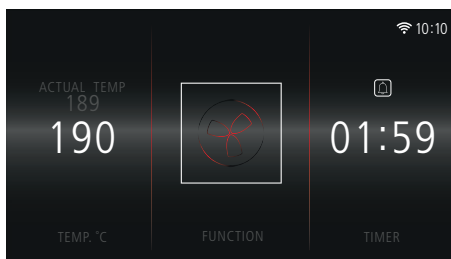

7. Cooking will begin and the main cooking screen will display.



8. When cooking has completed. **'COOKING FINISHED'** will appear.

If a timer has been set, turn off the end of cooking alarm by pressing either  or  button.

Pressing the  button will cancel the alarm and turn the light on.

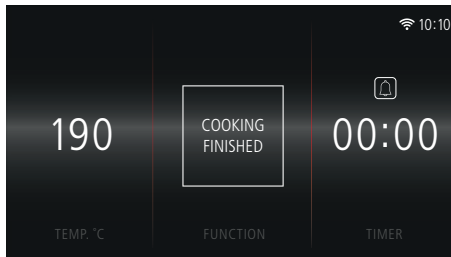

MULTI-STAGE COOKING

1. Press  to turn the appliance on.
2. Select desired Function, Temperature/Power, Steam+ (if required).

Then press 

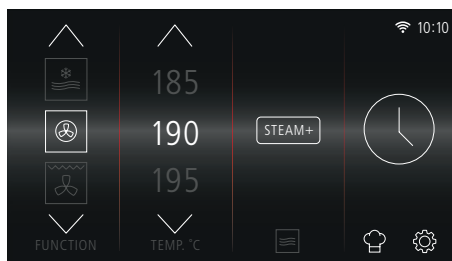

NOTE:

Microwave and Microwave Combi Functions cannot be used for Multi-Stage cooking. If one of these Functions is selected when adding an Additional Cooking stage, **'MICROWAVE FUNCTIONS ARE NOT AVAILABLE FOR MULTI-STAGE COOKING'** message will appear.



3. Select a Cooking Duration.

To add additional cooking stages press 

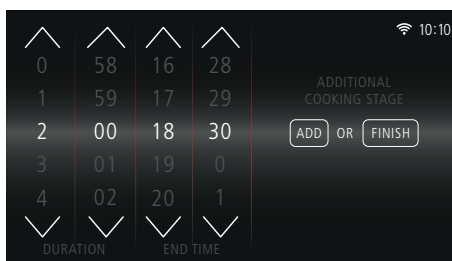

4. Select desired Function, Temperature/Power, Steam+ (if required).

Then press 

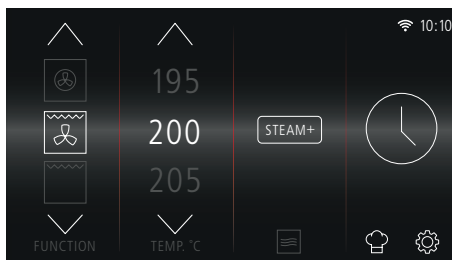

NOTE:

If  is pressed before a 2nd stage timer has been selected, 'PLEASE SELECT COOKING TIME' message will appear.

Select a cooking Duration and/or End Time to continue.

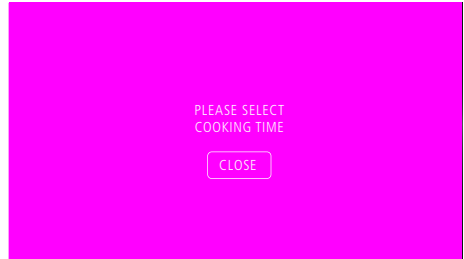



5. Select 2nd cooking stage Duration.

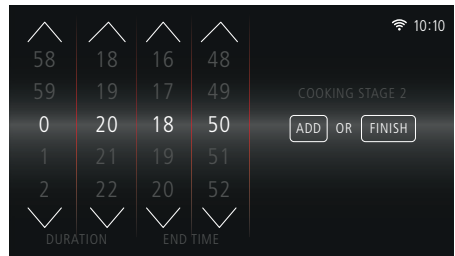

Further Cooking Stages (maximum of 4 in total) can be added by repeating the  process.

Press  to go to overview screen.





6. Review selection, press  to change selection.

Press  to begin cooking without saving or press  to store in the favourite's menu.

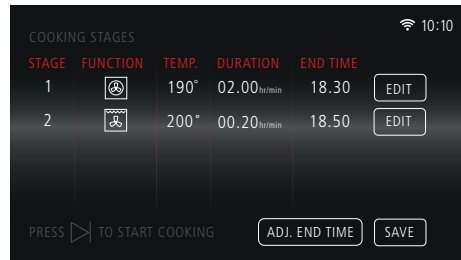
NOTE: If you press  on multi-stage cooking, the timer will reset. Press  to reset time before proceeding.



7. Name your selection, press  and then press  to store to favourites.

NOTE:

Selection names are limited to 14 characters.

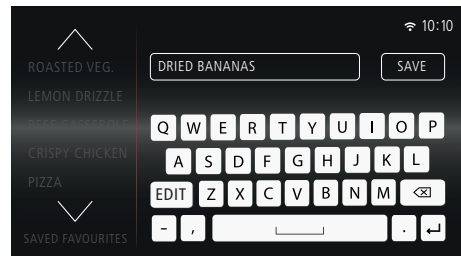

8. Press  to begin cooking.

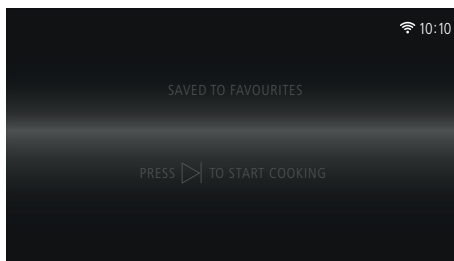

9. Cooking will begin and the main cooking screen will display.

EDITING STAGES BEFORE COOKING

1. To Edit a cooking stage before cooking has begun, press **EDIT** next to the relevant stage on the Cooking Review screen.

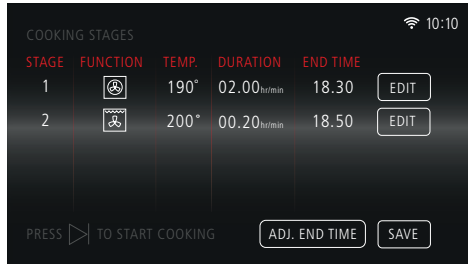

2. The Cooking Selection Screen will appear for the chosen cooking stage. Make the necessary amends and then press to continue.

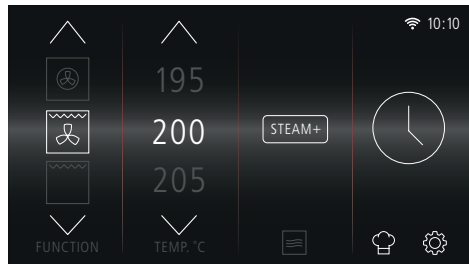

NOTE:

When multi-stage cooking, pressing **EDIT** will reset the timer for that cooking stage.

If is pressed before a timer has been selected, **'PLEASE SELECT COOKING TIME'** message will appear.

Press , select a cooking duration and/or End Time to continue.

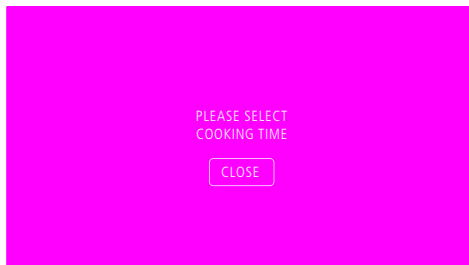

If you no longer want to Edit the selected cooking stage press the < button.

'WOULD YOU LIKE TO CONTINUE EDITING OR REVIEW COOKING'

message with appear.

Press **REVIEW** to return to the cooking review screen.

Press **EDIT** to continue editing.

NOTE:

Please refer to bottom of page 42 for more information on Adjusting the End Time before cooking.

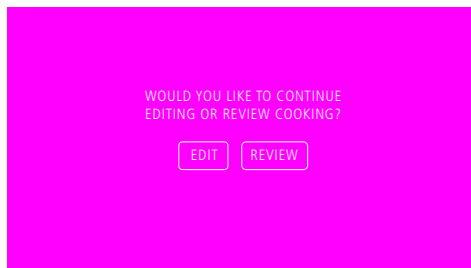

CANCELLING STAGES BEFORE COOKING

To Cancel your cooking stage(s) before cooking has begun, press the < button when in the Cooking Review screen.

The Homescreen will appear and any previous cooking stage(s) will have been cancelled.

NOTE:

During multi-stage cooking, all cooking stages will be cancelled.

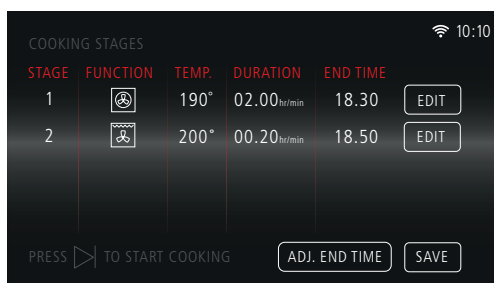

AUTOMATIC COOKING

After selecting a Cooking Duration, you can adjust the End Time so that your cooking automatically starts later in the day.

Oven Start Time = End Time – Duration

For example: If you select a Duration of 2 hours and an End Time of 6:30pm, your cooking Start Time will be 4:30pm.

After selecting desired cooking Duration and End Time, press  to begin cooking. The standby screen will appear with **'COOKING WILL START AT...'** message.

At the Start Time, the oven will automatically turn on and begin cooking.

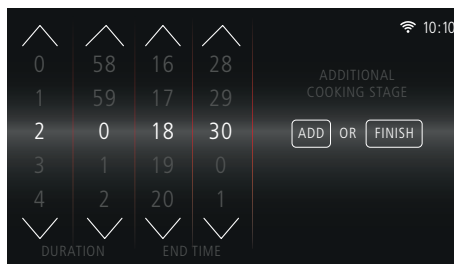

NOTE:

To set automatic cooking for multi-stage cooking, do not adjust the end times in the timer section. Use the **ADJ. END TIME** button in the review screen, as this will edit the end time of all cooking stages.

NOTE:

An End Time cannot be set for the Microwave only Function and Microwave with Steam Function.

END TIME ERROR

If an End Time is selected that is sooner than the **'Current Time + Duration Time'**, an Error message will display.

For example: If the current time is 10:10am, you select a Duration of 2 hours and an End Time 12:00pm, the Error message will appear.

I.E. $10:10 + 02:00 = 12:10$

Adjust the end time accordingly, so **'IT IS EQUAL TO OR GREATER THAN THE CURRENT TIME + DURATION TIME'** to proceed.

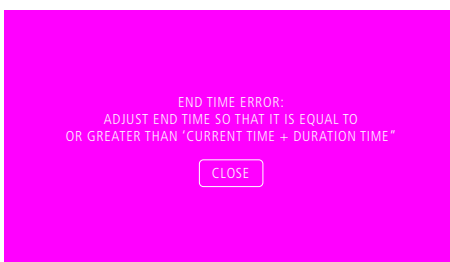
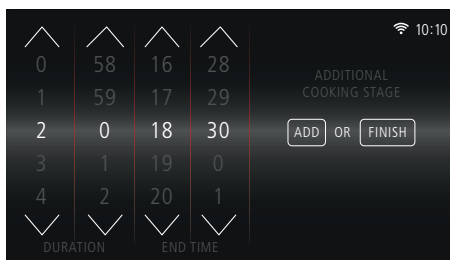

AUTO-TIME

If no Timer is set, when you press ▶ to begin cooking, the Timer will count up from 00:00, so you can see how long you have been cooking.

NOTE:

Auto-Time excludes all Microwave cooking functions.

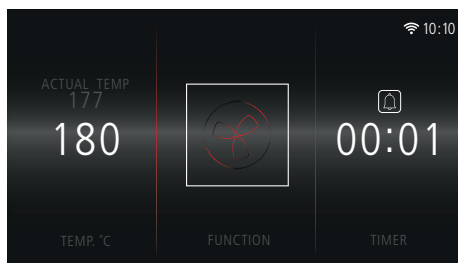

ADJUSTING COOKING TEMPERATURE, POWER AND TIMER DURING COOKING

It is simple to make adjustments to the Cooking Temperature, Power and Timer from the main cooking screen.

ADJUST TEMPERATURE

Touch the Temperature ('180') to adjust. The left column appears as shown to allow adjustment.

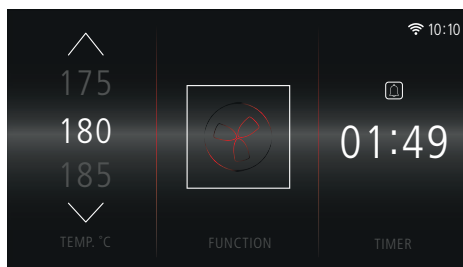

Once the new temperature is selected, wait 3 seconds for it to confirm. Once confirmed it will return to the normal cooking screen and display the new temperature.

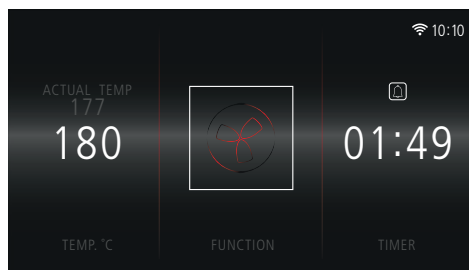

ADJUST POWER

Touch the Power (70) to adjust.

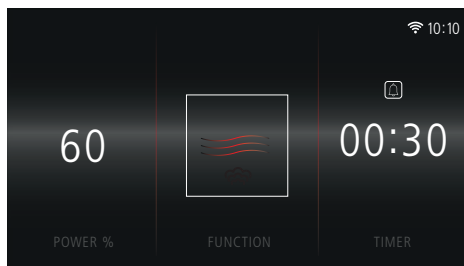

The left column appears as shown to allow adjustment.

Once the power is chosen, touch the power again to confirm. This will then return to the Main Cooking Screen.

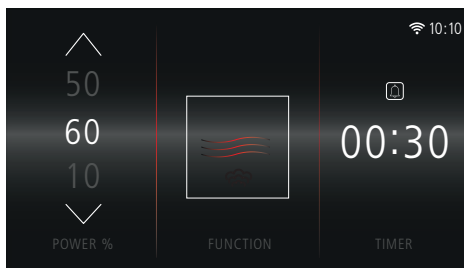

ADJUST TIMER

Touch the Timer Display ('01:49') to amend cooking time.

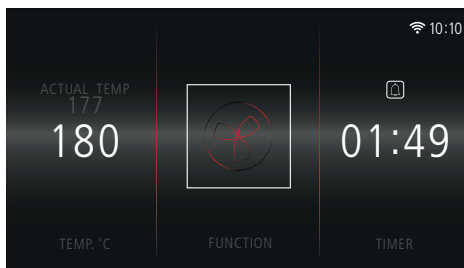

The Time Adjustment screen will appear.

Use controls to adjust the Duration and End Time, then press **FINISH** to return to Main Cooking Screen.

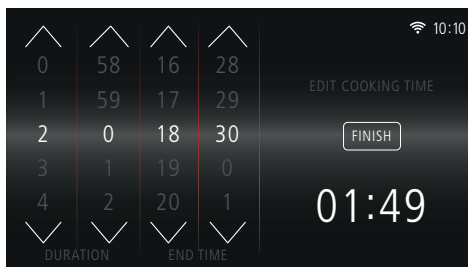

SETTING THE MINUTE MINDER

Pressing  on the main cooking screen takes you to the Minute Minder screen. Here you can set an alarm separate to the timer, to sound after a pre-set duration.

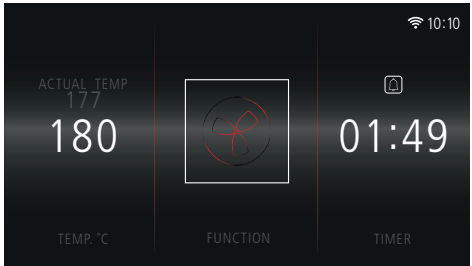

Use the controls to set the Minute Minder for your desired duration, then press **SELECT**.

If no adjustments are made, the main cooking screen will display after 3 seconds.

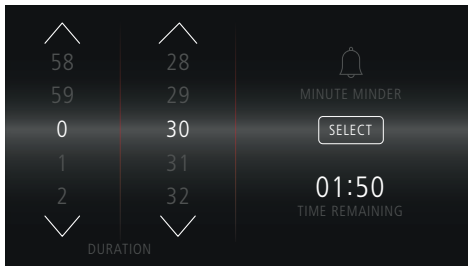

The Minute Minder Symbol will now appear white. Press the Minute Minder symbol again to view the time remaining before the audible alarm sounds.

NOTE:

To cancel the Minute Minder, press , reduce the Duration to 00:00, then press **SELECT**.

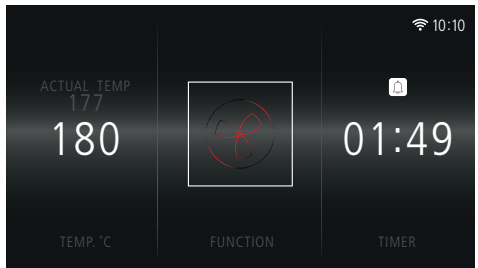

When the alarm sounds, the Minute Minder symbol will flash. To turn the alarm off, press .

ADJUSTING MICROWAVE POWER



For adjusting Microwave Power for Combi-Microwave functions before cooking.

Select a Combi Microwave function from the function selection screen and press 

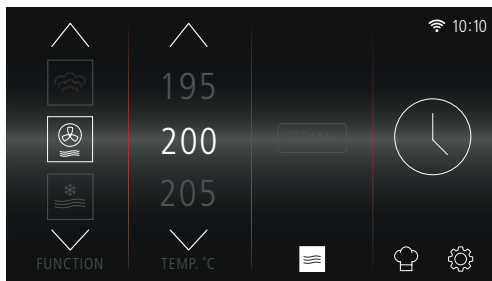

Select a power level and press **FINISH**

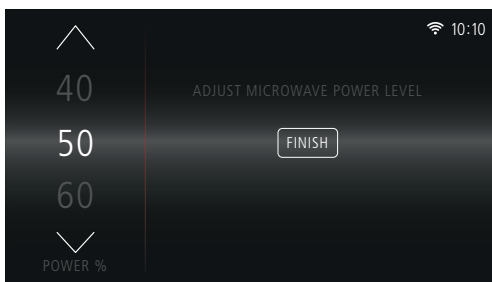

If necessary, select Duration, add additional Cooking Stages and/or save to Favourites.

Press  to start cooking.

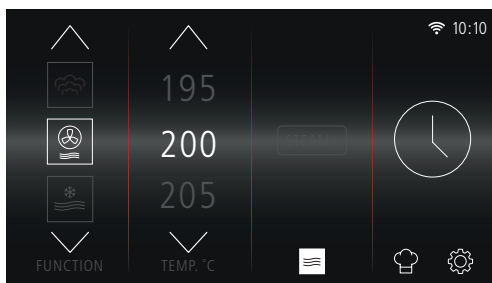

Main cooking screen displays set Power underneath set Temperature.

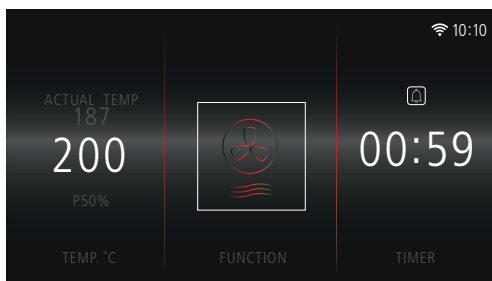

RESIDUAL HEAT

When cooking has completed, the oven's **RESIDUAL HEAT** will display on the Standby screen.

If you decide to make a new cooking selection and the Residual Temperature is greater than the Set Temperature, **'WARNING! Residual temperature is higher than set temperature'** message will appear.

Press **CLOSE** to remove the warning and proceed with cooking. You will still be able to proceed with your chosen temperature, this is just to warn you that the high residual temperature may effect your cooking results.

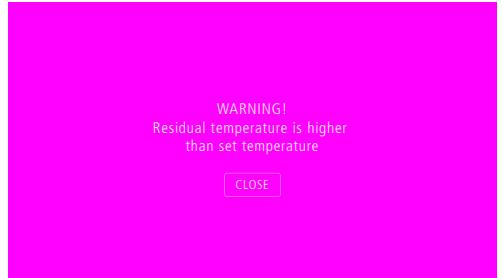

CHILD SAFETY LOCK



To activate the Child Safety Lock, press and hold the  button for 3 seconds.

COOKING: When the Child Safety Lock is turned ON during cooking, both the touch screen display and control panel (ON/OFF, LIGHT, BACK, START/PAUSE buttons) will be disabled.

NOT COOKING: When the Child Safety Lock is turned ON when you are not cooking, only the control panel (ON/OFF, LIGHT, BACK, START/PAUSE buttons) will be disabled.

When the lock is activated the symbol  will appear in the top left corner of the display screen.

To deactivate, press and hold the  button for 3 seconds.

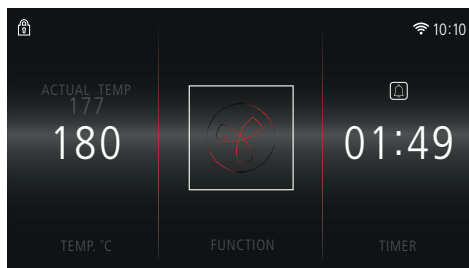

STEAM+

If STEAM+ is available, you can select this option to inject steam at preset points during cooking.

Each steam injection lasts for 60 seconds.

Select relevant function and press 

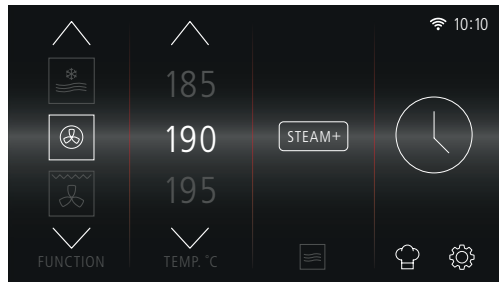

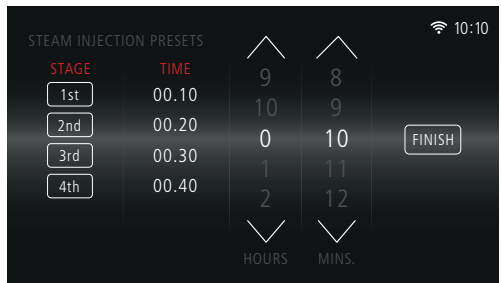

Steam can be injected at up to 4 preset points.

Press the STAGE buttons in the left column to activate. Set the timings as desired and press  to return to the Home Screen.

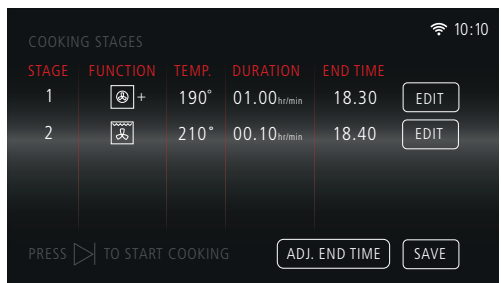

When activated, '+' will appear next to the function on the Cooking Stages Screen.



The  symbol will also appear above the function symbol on the cooking overview screen.

NOTE:

Only available on certain functions (see 'FUNCTIONS').

Before selecting the STEAM+ function, ensure the water tank has been filled.

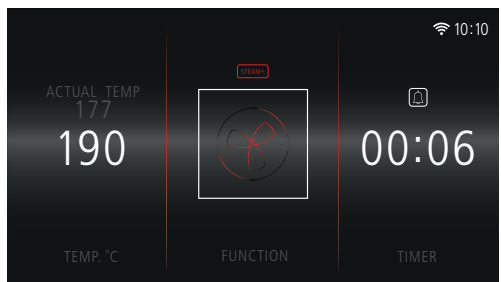

NOTE:

When using the STEAM+ feature, the End Time must be later than the last STEAM+ stage. If not, an END TIME ERROR message will display.

Adjust the end time accordingly, so 'IT IS AT LEAST 1 MINUTE LATER THAN THE LAST STEAM+ STAGE' to proceed.



END TIME ERROR:
END TIME MUST BE AT LEAST 1 MINUTE
LATER THAN THE LAST STEAM+ STAGE

CLOSE

FAVOURITES



- › To view your saved favourites, press  on the Function Selection Screen.

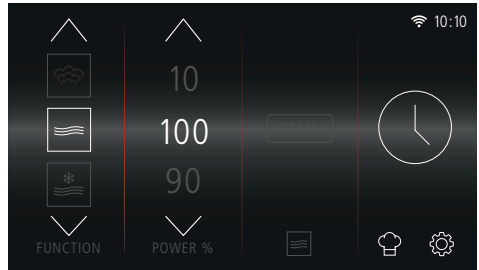

- › Choose from your favourites:
Press **SELECT** to view relevant cooking stages, edit stages if necessary and begin cooking.
Press **DELETE** to remove a saved favourite.



- › To confirm deletion, press **YES**
- › To cancel and return to previous screen, press **NO**

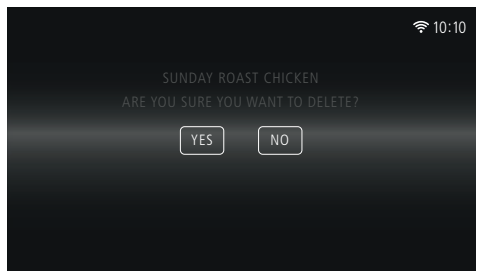

- › When a favourite cooking programme has been selected, the end time will reset based on the current time.
- › To start cooking later in the day press

ADJ. END TIME



- › Adjust the End Time and press **SELECT**

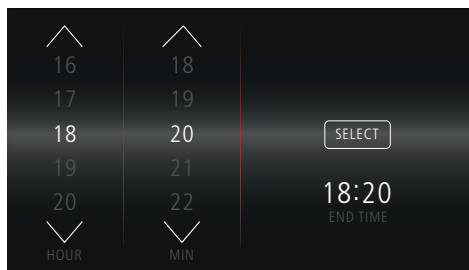

- › The Cooking Review Screen will now show the new End Time.
- › Edit or Save cooking selection if necessary, then press **▶** to begin cooking.

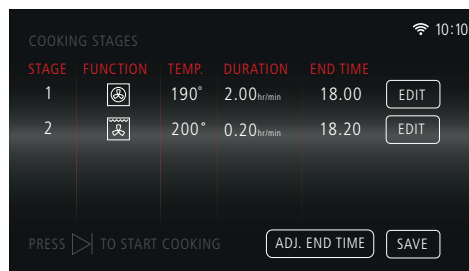

NOTE:

If an End Time is selected that is sooner than the **'Current Time + Duration Time'**, the **END TIME ERROR** message will display.

Adjust the end time accordingly, so **'IT IS EQUAL TO OR GREATER THAN THE CURRENT TIME + DURATION TIME'** to proceed.

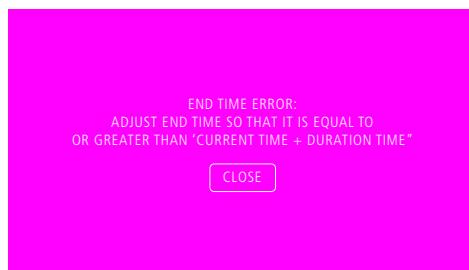

REVIEW AND CANCEL COOKING

To review and/or cancel your selection after cooking has begun, press the **<** button.

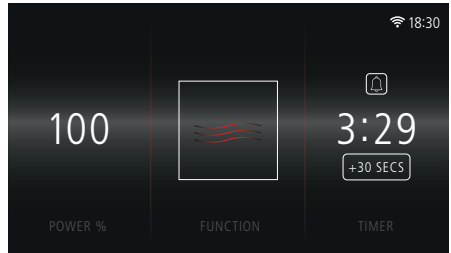

- › From here, proceed to select either **YES** **NO** or **REVIEW**

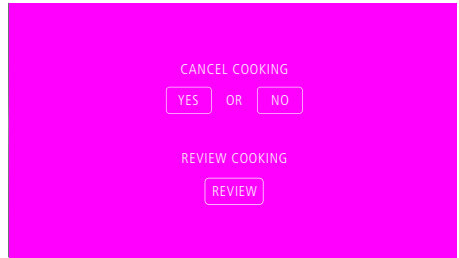

- › Selecting **REVIEW** will display the cooking stages screen.
Press **CONTINUE** to resume cooking.

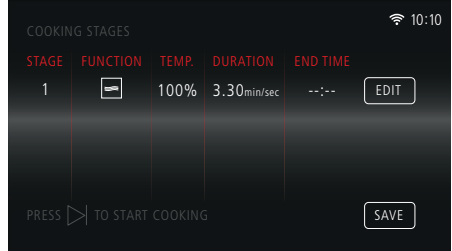

- › Selecting **YES** will end cooking and display the home screen.
- › Selecting **NO** will return to the main cooking screen.

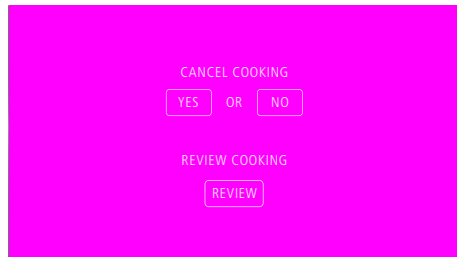

PAUSE COOKING

To pause cooking press the ▷ button.

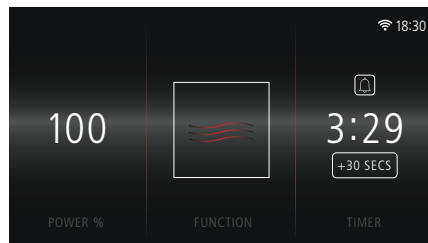

'COOKING PAUSED...' message will display.

Press ▷ to continue cooking.

NOTE:

Pause will only work when one cooking stage has been set.

If the ▷ button is selected during Multi-Stage Cooking,

'PAUSE FUNCTION NOT AVAILABLE...' message will display.

Press to return to the main cooking screen.

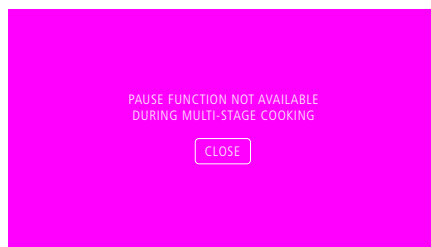
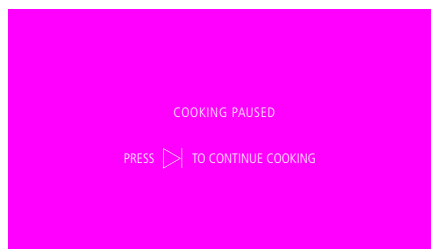

NOTE:

When cooking is paused, the < will not work. If you would like to cancel cooking, press ▷ to resume cooking, and then press the < button to cancel cooking.

SETTINGS MENU

The settings menu is accessed by pressing the  symbol on the home screen.

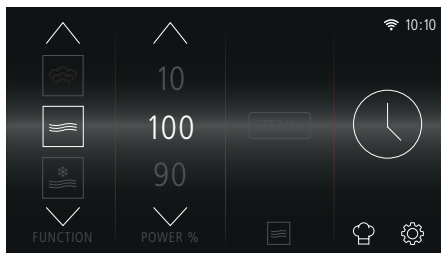

From here you will be able to customise the following options for your oven:

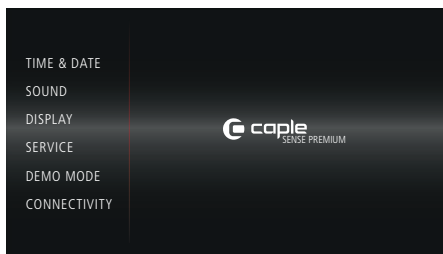

TIME AND DATE

Adjust the Time using the controls before pressing **SET TIME**

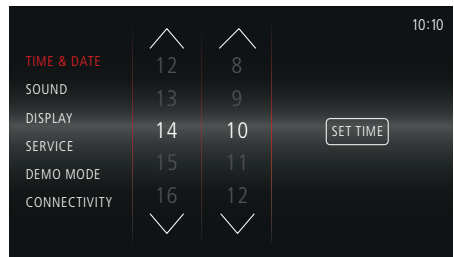

Press **SELECT** underneath Analogue or Digital.

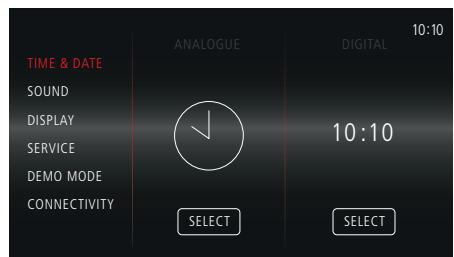

If Digital is selected, choose either a 24- or 12-hour clock, by pressing **SELECT** underneath your desired option.

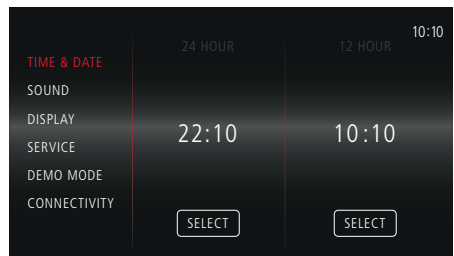

Adjust Date using the controls before pressing **FINISH** to return to the Settings Menu.

Press the **<** button to return to the home screen.

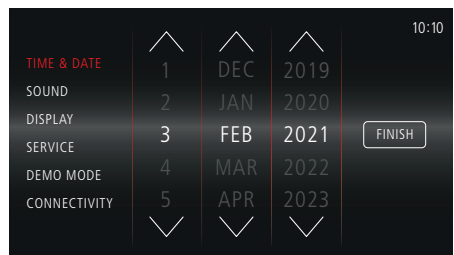

SOUND

Set Key Tone, Key Volume and Alarm Volume levels.

After making your adjustments, select a different setting option from the menu or press the < button to return to the home screen.

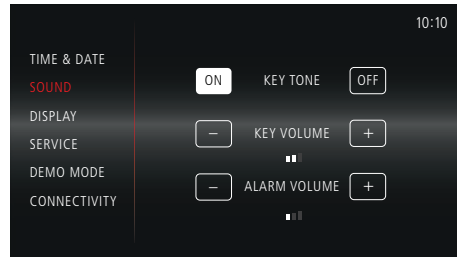

DISPLAY

Choose whether to display Date and Time as well as adjust the screen brightness.

If **ON** is selected for '**Display Date**' or '**Display Time**', the Night Mode option becomes available.

If **OFF** is selected, then this option will be unavailable.

Night mode is an Energy Saving option where between the hours of 11pm and 6am, the brightness of the display is reduced to the minimum.

After making your adjustments, select a different setting option from the menu or press the < button to return to the home screen.

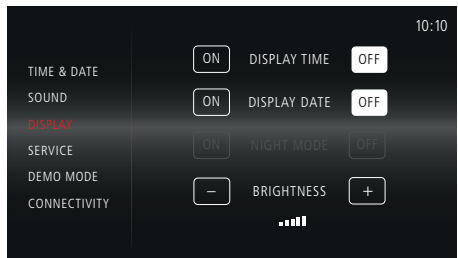
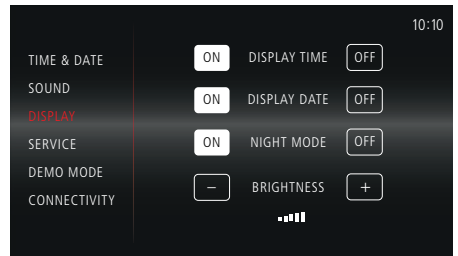

SERVICE

View Error codes and reset the appliance.

After making your adjustments, select a different setting option from the menu or press the < button to return to the home screen.

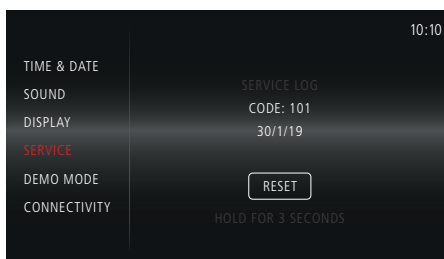

DEMO MODE

In Demo Mode, the normal operation of the cooling fan, circulation fan and lighting work normally, however all heating elements and other functions are disabled.

If the oven is turned off, it will remain in Demo Mode when the oven is turned back on.

When Demo Mode is turned on 'DEMO' is shown at the top of all screens.

After making your adjustments, select a different setting option from the menu or press the < button to return to the home screen.

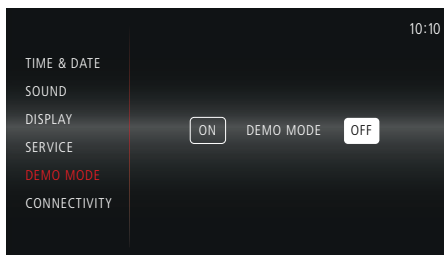
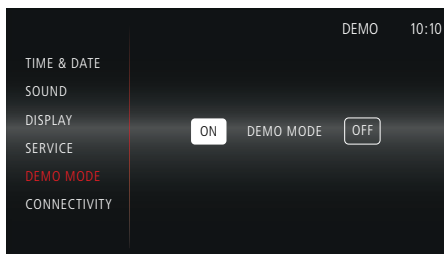

CONNECTIVITY

NOTE:

Download the CapleHome App to your mobile device/tablet, prior to connection setup.

Press to enable WIFI.

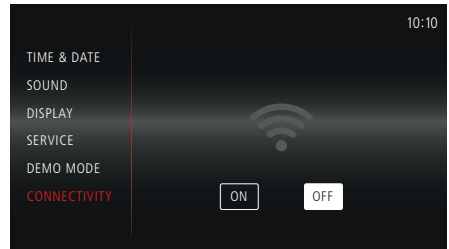

Follow the on-screen prompt to open the CapleHome App and follow instructions on your device to connect to WIFI.

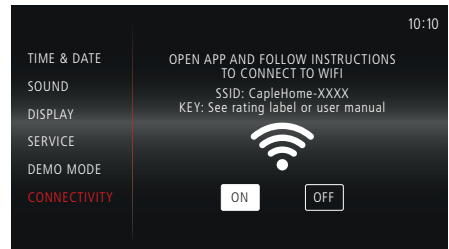

Once the appliance is connected to your mobile device/tablet, **'connected to...'** message will display and the  symbol will appear in the top right corner next to the time.

To disable WIFI press

After making your adjustments, select a different setting option from the menu or press the  button to return to the home screen.

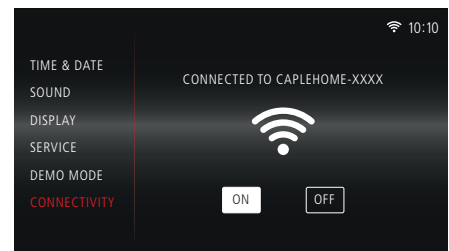



NOTE:

By connecting the appliance to the Caple Home App, you are allowing the appliance to be controlled by the App.

WiFi frequency: 2.4Ghz

APPLIANCE FUNCTIONS

	MICROWAVE	Standard microwave cooking function. Ideal for reheating leftovers.	
	FAN HEAT	Both the fan and circular heating element operate together for the most even air distribution. This is the ideal cooking method for several types of food (meat & fish, pastries etc.).	
	GRILL	Full width grill, for even and consistent grilling of dishes such as large pieces of meat and fish.	
	TURBO GRILL	The heat which is produced by the top element and grill is circulated by the fan for faster and more even cooking. Perfect for quick browning foods such as potato gratin or lasagne.	
	MICROWAVE & FAN HEAT	Microwave and fan heat element reduces cooking times with the addition of even cooking. Perfect for cooking fluffy jacket potatoes in a quarter of the time.	
	MICROWAVE & TURBO GRILL	Uses microwave, fan and grill for quick browning. Ideal for cooking meat and keeping all the juices.	
	STEAM	One of the healthiest cooking methods retains moisture and locks in nutrients. Perfect for cooking multiple food types on one way tray with no transfer of flavours. Its low cooking temperatures are ideal for reheating foods.	
	TURBO GRILL WITH STEAM	A combination of the Turbo Grill function with added Steam to help preserve moisture and flavours in food.	
	GRILL WITH STEAM	Both the top heating element and grill element operate together to grill larger quantities of food. Combined with Steam to help preserve moisture and flavours in food.	

	<p>FAN HEAT WITH STEAM</p>	<p>Uses normal fan heat for even heat distribution with the added benefit of the steam injecting moisture into the cavity. Perfect for retaining moisture in meat.</p>	
	<p>MICROWAVE WITH STEAM</p>	<p>Microwave and Steam elements operate alternatively to cook your food quickly and healthily. Ideal for reheating food without drying it out.</p>	
	<p>DEFROST</p>	<p>Microwave function works at reduced power to carefully defrost food.</p>	
<p>DESCALE</p>	<p>DESCALING</p>	<p>This function is used for descaling the water system. Ideal for prolonging the life of your oven.</p>	

SPECIAL FUNCTIONS

MICROWAVE



Microwave Function has a default power setting of P100. If necessary, choose a cooking Duration and/or save to favourites.

Press  to start cooking.

NOTE:



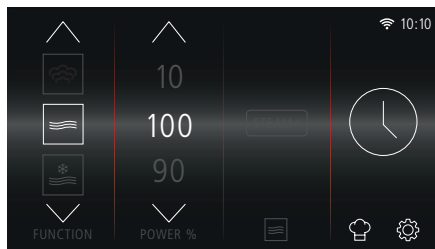

Microwave Function uses minutes and seconds instead of hours and minutes.



MICROWAVE AND FAN HEAT



Microwave and Fan Heat Function has a default temperature of 200°C and default power of P50.

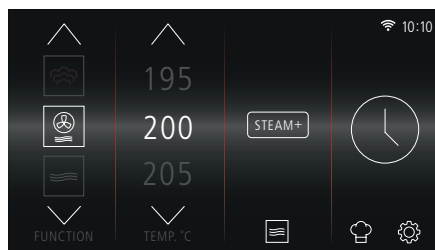

- › Turn on the oven by pressing the  button.
- › Select  from the Function Selection screen.
- › Press  to adjust power level.
- › If necessary, choose a cooking Duration and/or save to favourites.
- › Press  to start cooking.





STEAM

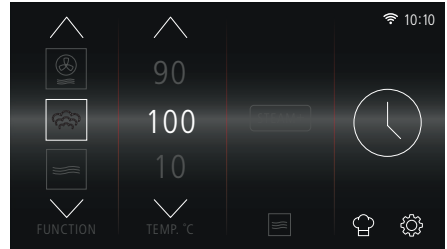

Steam Function has a default temperature of 100°C and default duration of 20 minutes.

- › Turn on the oven by pressing the  button.
- › Select  from the Function Selection screen.
- › If necessary, select a cooking Temperature and Duration and/or save to favourites.



Pressing  takes you to the **PREHEATING** screen. A 5 minute countdown will begin to achieve the desired temperature.

NOTE:

Preheating will only happen during single stage cooking.

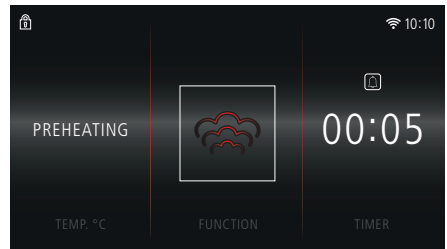

When the 5 minute countdown reaches '00:00', the main cooking screen will display and the cooking sequence will begin.

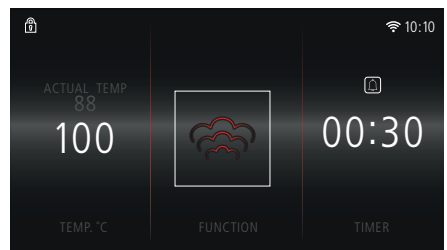

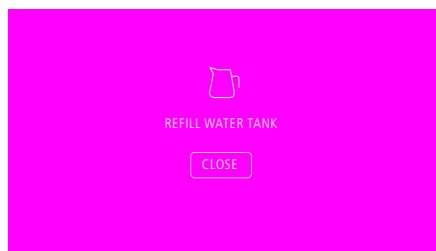

'**Refill water tank**' warning message will appear when the water tank level is too low.





MICROWAVE WITH STEAM

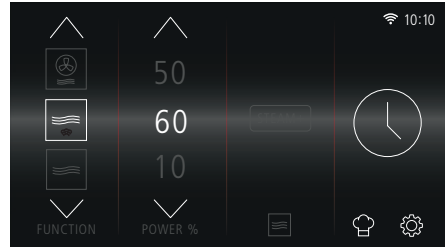

This function starts with the Steam Function until the temperature reaches 100°C. The Microwave and Steam Functions then operate alternatively to cook the food.

- › Turn on the oven by pressing the  button.
- › Select  from the Function Selection screen.
- › If necessary, select a cooking Power and Duration and/or save to favourites.
- › Press  to start cooking.



- › Pressing  takes you to the PREHEATING screen.
- › A 5 minute countdown will begin to achieve the desired temperature.

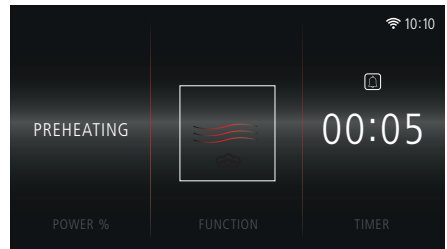

- › When the 5 minute countdown reaches '00:00', the main cooking screen will display and the cooking sequence will begin.

NOTE:

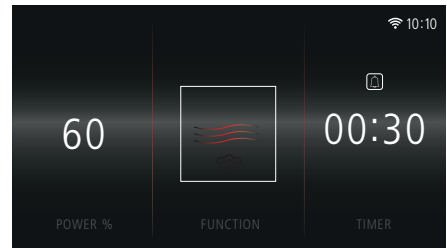

Microwave with Steam Function uses minutes and seconds instead of hours and minutes.



DEFROST



Weight is default to 1000g. Adjusting the weight will automatically adjust the operation time. Time can also be adjusted manually.



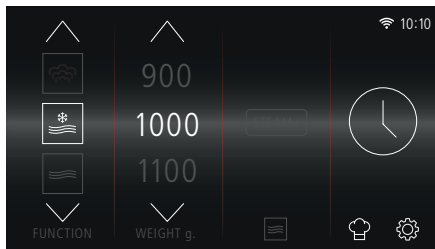

- › Turn on the oven by pressing the  button.
- › Select  from the Function Selection screen.
- › If necessary, select a Weight and Duration and/or save to favourites.
- › Press  to start Defrosting.



DESACALE

DESCALE

Descaling is important to ensure the correct functioning of your appliance and should be carried out at least every 6 months. This should be carried out sooner if the Steam Function is used more often or if you live in an exceptionally high hard water area.

- › Turn on the oven by pressing the  button.
- › Select  from the Function Selection screen.
- › Press  to start Descaling.
- › 'FILL WATER TANK AND ADD DESCALER TO WATER' message will appear. Follow the on-screen instruction and press  to continue.

NOTE:

Press and hold  to remove the water tank.

- › 'START DESCALE PROCESS' will appear.
- › Press  to start Descaling.

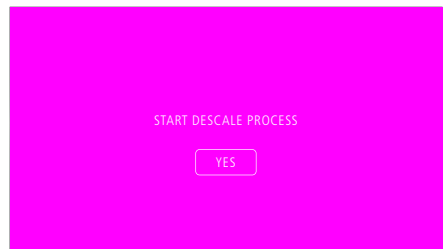
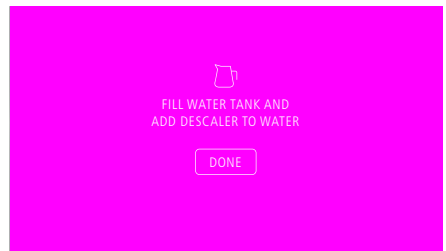
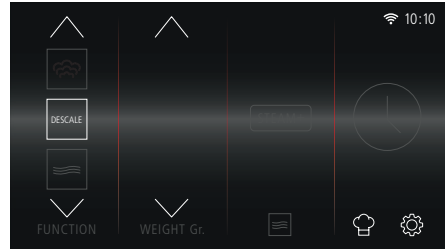

- › Stage 1 of 2 will begin. This stage will last 26 minutes.

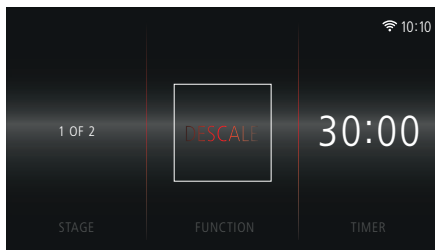

- › When stage 1 is complete, 'EMPTY & RINSE WATERTANK ADD CLEAN WATER' will appear.
- › Follow the on-screen instruction.
- › Press **DONE** to continue.

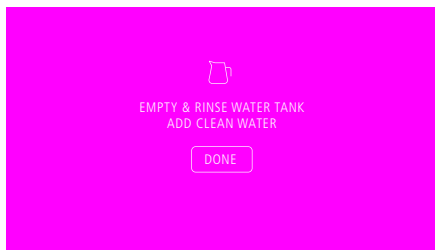

- › Stage 2 of 2 will begin. This stage will last 4 minutes.

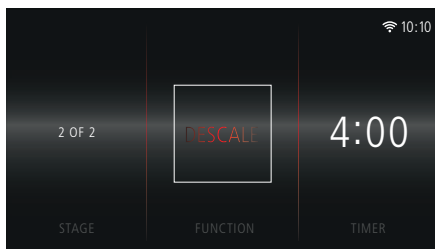

- › '**DESCALE COMPLETE**' will appear when the process has finished.
- › Follow the on-screen instruction.
- › To return to the home screen, press

DONE



› **NOTE:**

A warning message will appear and alarm will sound when the water tank is empty.

To continue the descaling process, fill tank with water and press **DONE** to continue.

Descaler kits can be purchased directly from **www.caple.co.uk**



CARE AND MAINTENANCE

Your appliance has been designed to give years of trouble-free use provided it is installed and maintained correctly. Please disconnect the power supply before cleaning or maintenance is performed.

Do not pull the cable to disconnect power.

When cleaning the cavity, please remove everything in the cavity including the shelves and use a clean cloth to clean it.

Do not spray water directly on the unit. Do not use abrasive material.

The cavity must be cleaned after every use, wait until the cavity has fully cooled down, use a dry cloth to clean the cavity, or keep the oven door open to let the cavity dry out.

It is recommended to descale the steam oven once every three months. For details you can refer to the descaling function section.

Please clean the water tank regularly. When you clean the water tank, please remove the cover and use a dry cloth to wipe it.

REPLACING THE LIGHTS

Should the lighting need replacing, please contact Caple Service for further information;

Phone: **0117 938 7420**

Email: **service@caple.co.uk**

REMOVING THE DOOR

To make it easier to clean the inside of your oven, the oven door can be removed by proceeding as follows (Fig. 1-2):

- › Open the door completely and lift the 2 levers "B" (Fig.1);
- › Now, shutting the door slightly, you can lift it out by pulling out the hooks "A" as shown in figure 2.

TO REASSEMBLE THE DOOR

- › With the door in a vertical position, insert the two hooks "A" into the slots;
- › Ensure that seat "D" is hooked perfectly onto the edge of the slot (move the oven door backwards and forward slightly).
- › Keep the oven door open fully, unhook the 2 levers "B" downwards and then shut the door again.

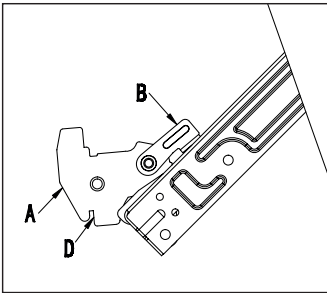

Fig 1

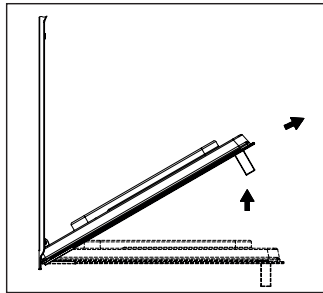

Fig 2

Scan the QR code below to access the 'How to video'.



ACCESSORIES

WIRE SHELF (FIG.1)

The wire shelf allows you to brown or grill food. The shelf can be used for normal fan heat, conventional cooking and grilling functions only. It must not be used for any microwave function.

If a microwave function is selected, ensure the wire shelf has been removed before the start.

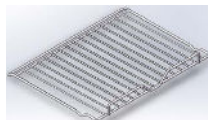

Fig. 1

WARNING:

Do not use the wire shelf with any microwave function. This could damage the shelf or even your microwave oven. The wire shelf is for normal convection/Fan cooking or grilling only.

GLASS TRAY (FIG.2)

The glass tray allows you to cook foods on normal fan heat, conventional cooking, grilling functions, microwave and combi-microwave functions.



Fig. 2

WARNING:

- › Do not use the glass tray on or under a flame or other direct heat source.
- › Do not drop or hit the tray against hard objects or strike utensils against it.
- › Handle the glass tray with care to prevent breakage, chipping, cracking or severe scratching. Do not use or repair the tray if it is chipped, cracked or severely scratched.
- › Avoid sudden changes in temperature to the glass tray.
- › Do not use the Grill Rack supplied with the glass tray with any microwave function. This could damage the rack or even your microwave oven. The wire rack is for normal convection/Fan cooking or grilling only.
- › Do not use the glass tray on the bottom of the appliance cavity. The glass tray should be used on the side shelf supports only.

THE SIDE SHELF SUPPORTS (FIG.3)

2 hook-on shelf supports allow you to use the accessories on three levels. Three cooking levels are available, depending on the method used and the type of food. With the Grill setting, the accessories (shelf or tray) are placed on the first level for thick foods like roasts and on the third level for thinner foods like sausages. In normal cooking modes, the shelf or tray should be used on the first or second levels depending on the item(s) being cooked.

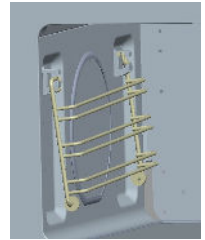

Fig. 3

GLASS BASE PLATE (FIG.4)

When microwaving, foods and beverages can be placed on the Glass base plate. The Glass base plate protects the bottom of the microwave cavity from any scratches, marks or spillages. It can also be easily removed for cleaning by either hand or in the dishwasher.



Fig. 4

NOTE:

Always remove the wire shelf when using microwave functions, as this could damage the oven.

STEAM TRAY

The perforated stainless steel tray allows the steam to circulate around the food and cook evenly.

WARNING:

Do not use the Steam Tray with any microwave function. This could damage the tray or even your microwave oven. The Steam Tray is for Steam cooking only.

STEAM COOKING - IMPORTANT INFORMATION

1. If you want to remove food from the oven immediately after cooking, please use oven gloves or other tools to avoid burning yourself.
2. Water droplets will form on the unit when it is in use, please wipe them away during cooking being careful on the glass which may be hot.
3. Do not open the oven door immediately after cooking to avoid scalds or burns by the steam.
4. Always clean or descale the cavity and food tray or racks.
5. If the power socket is damaged, to avoid hazard, please Caple service to replace.
6. If the product will not be used for a long period of time, please clean away the water in the oven, and disconnect with power supply.
7. Do not put excess food in the oven, to avoid uneven steam circulation in the cavity.
8. The yellow/green earth wire should not be controlled by the switch.
9. To prevent water overflowing from the tank, the water suction tool can be used to remove excess water. After steam cooking, please empty the remaining water in the tank and remove any excess water in the base of the oven using the suction tool supplied.
10. Fill the tank with water. The water level must not be higher than the 'MAX' mark on the water tank. A full tank of water will last you up to 2 hour and 30 mins.
11. During steam cooking, do not cover the food, as this will prevent steam from cooking the food.
12. If the water tank is empty when a steam programme is started, the warning will appear on the display, the tank will eject, an alarm will sound and the steam function will not start.
13. When the water tank is removed, wait for at least 10 seconds before reinserting it.
14. When inserting the water tank, ensure it is fully pushed in, otherwise the cooking programme will not start.

USEFUL TIPS

When using the steam oven, always start with the oven cold. Using steam in a hot oven (immediately after traditional cooking) is not recommended because the benefits of cooking with steam will be cancelled out.

For steam cooking try to use the perforated stainless-steel tray together with the lower glass tray as much as possible.

The perforated tray, resting with its support on the flat grill, allows the steam to fully cook the food while draining everything released by the food during cooking through the holes.

The second, lower tray, slid under the grill on its guides, will collect the drippings and keep the oven chamber cleaner.

SUGGESTED STEAMING TIMES

FOOD TYPE	WEIGHT	TIME
FISH	650g	15 minutes
CRAB	500g	25 minutes
SHRIMP	500g	12 minutes
CHICKEN LEG	5pcs around 650g	30 minutes
CHICKEN	1100g	35 minutes
BEEF	350g	40 minutes
PORK	400g	20 minutes
SOUP	450g	15 minutes
EGG	10pcs around 650g	15 minutes
PUMPKIN	850g	20 minutes
TOMATO	550g	30 minutes
CORN	550g	30 minutes
BREAD	100g	18 minutes
RICE	400g	30 minutes

CAPLEHOME APP

Please read carefully through this section to make sure you understand how the App functions.

CONNECTING YOUR OVEN

Download the CapleHome App from www.caple.co.uk or the relevant app store for your device.

When the App is opened for the first time, the **LOGIN/SIGN UP** Screen will appear. Use your details to Sign Up and/or Login.

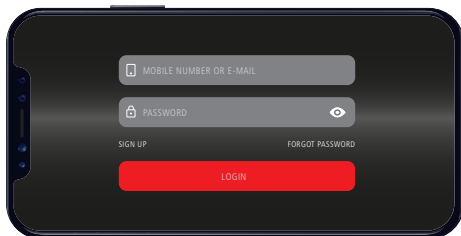

The App Home Screen will display. To begin appliance connection, press 

NOTE:

Make sure WIFI is turned On in your appliance settings (page 53). Also make sure your phone or device is connected to your home WIFI network.

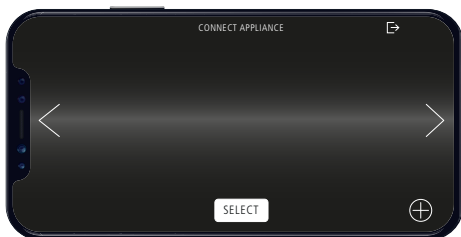

Further instructions on how to connect your appliance to the CapleHome App are available from www.caple.co.uk or, scan the QR Codes to access the video 'How to guides'.

iOS



Android



Choose to add an additional appliance by repeating previous steps or use the arrows <> to choose the appliance you wish to control. Press **SELECT** to display the appliance's Function Selection Screen.

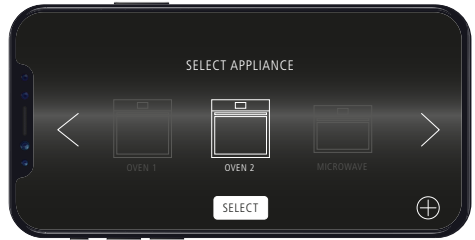

IMPORTANT:

If the Oven WIFI is turned Off, you will need to go through the connection process again.

HOW TO LOG OUT

To Log Out of your CapleHome account go to the App Home screen and press  'ARE YOU SURE YOU WANT TO LOG OUT...' message will appear. Press **'LOGOUT'** to proceed. The login screen will appear.

HOME SCREEN

The CapleHome App is designed to mirror your appliance display:

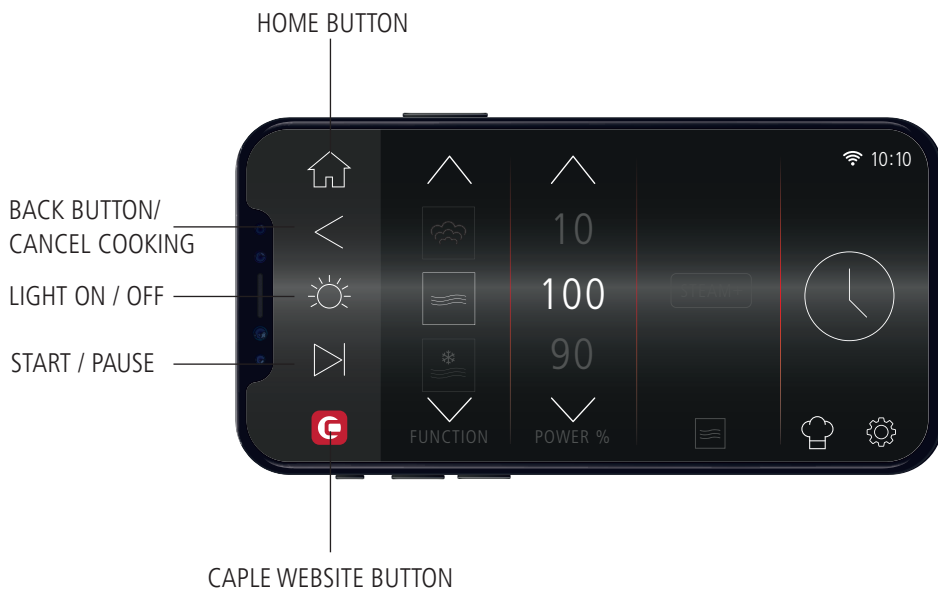

HOME BUTTON

Press to return to the 'SELECT APPLIANCE' screen. From here you can select another appliance you wish to control.

NOTE:

Pressing this button will not cancel cooking.

BACK BUTTON / CANCEL COOKING

Press to return to the previous screen on the display.

Press to cancel cooking.

LIGHT BUTTON

This will appear 'grey' when the internal light is Off. The button will illuminate when the internal light is On.

START/PAUSE BUTTON

After turning the appliance on, select your desired cooking programme and duration and press  to start cooking.

NOTE :

A duration time must be set in order to start cooking via the App. If  is pressed before a duration is set, the appliance will not start cooking.

This is a safety measure to ensure the appliance is not accidentally started via the App, especially if children are playing with it.

CAPLE WEBSITE BUTTON

Takes you to the Caple website where you can also review the Instruction Manual and CapleHome App Connection Guide in digital form if preferred.

FAVOURITES

Cooking selections can be saved to your appliance, the CapleHome App on your chosen device, or both.

To save to Favourites, open the CapleHome App on your device and follow the instructions as detailed in **'SETTING COOKING STAGES AND SAVING TO FAVOURITES'**.

NOTE:

When saving a favourite cooking selection on the CapleHome App or appliance, they do not copy over to the other. For example, if you save a favourite to the App, it will only save there, and not onto the appliance, and vice versa.

If you wish to save the same favourite to your appliance and the App they will have to be entered separately.

LANGUAGE

Several languages are available to choose from whilst operating the CapleHome App.

- › To change the language go to , LANGUAGE.
- › Scroll through the options and then press

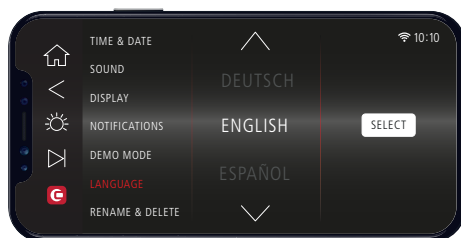

- › 'SET LANGUAGE APP WILL RESART...' message will appear. Press 'OK' to continue. The CapleHome App will close, simply open the App again to continue using with the new language.

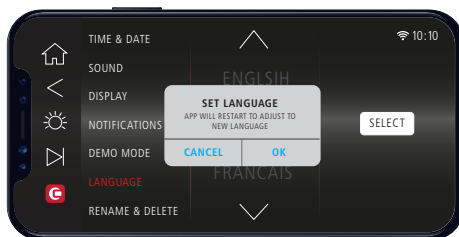

NOTIFICATIONS

From the Function Selection Screen, go to  , **NOTIFICATIONS** to turn notifications On or Off.

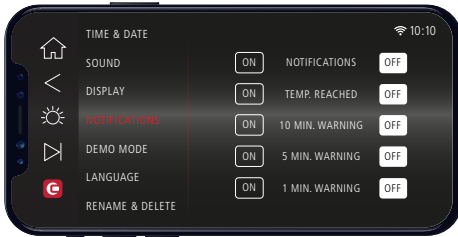

When turned On, notifications will appear outside of the App, on your mobile or smart device.

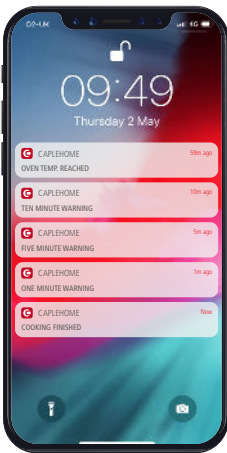

NOTE:

By connecting the appliance to the Caple Home App, you are allowing the appliance to be controlled by the App.

RENAME & DELETE

To rename or delete an appliance from the CapleHome App, proceed as follows:

- › Choose the appliance you want to Rename or Delete from the App Home screen and press **SELECT**

- › Go to  **RENAME & DELETE.**



TO RENAME AN APPLIANCE

- › Click on the existing appliance name (for example 'OVEN 2') and enter a new name.
- › Press 'RENAME'
- › The new appliance name will appear on the App Home screen.

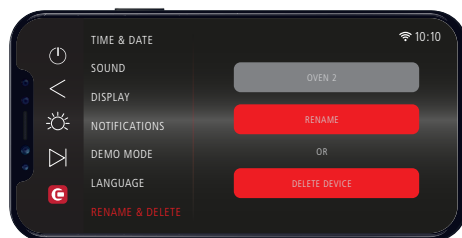

TO DELETE AN APPLIANCE:

- › Press 'DELETE DEVICE'
- › The deleted appliance will no longer show on the App Home screen.

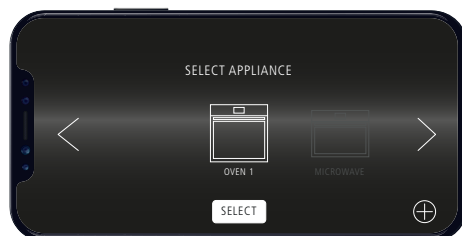

TROUBLESHOOTING

TROUBLE	SOLUTION
Control panel is not working	Check to see if the child lock is on. If so, unlock the appliance
Food is not cooked after steaming.	The food is sealed with a cover. Remove the cover.
The interior light does not illuminate.	Contact Caple Service.
The oven is not heating.	The thermostat is not turned to a temperature.
The oven does not operate.	Check it is switched on at the mains. There has been a power cut. The time is not set.
Lack of water pop-up screen.	No water in water tank/bad pumps. Refill tank with water. Replace water pump - contact Caple Service.

If the problem still persists, please contact Caple service for assistance:

Phone: **0117 938 7420**

Email: **service@caple.co.uk**

USEFUL NOTES FOR COOKING

In the following table, some indicative hints for cooking:

FAULTS	CAUSES	REMEDIES
The upper crust is dark and the lower part too pale	Not enough heat from the bottom	<ul style="list-style-type: none"> » Use the natural convection position » Use deeper side tins » Lower the temperature » Put the cake on a lower shelf
The lower part is dark and the upper crust too pale	Excessive heat from the bottom	<ul style="list-style-type: none"> » Use the natural convection position » Use lower side tins » Lower the temperature » Put the cake on a higher shelf
The outside is too cooked and the inside not cooked enough	Too high temperature	Lower the temperature and increase the cooking time
The outside is too dry even though it is the right colour	Too low temperature	Increase the temperature and reduce the cooking time.

ERROR CODES

ERROR CODE	ERROR	REASON
ER02	Cavity Thermostat open/short circuit.	PCB detects an open or short circuit in the thermostat.
ER04	Steamer Thermostat open/short circuit.	PCB detects open or short circuit in the thermostat.
ER05	Steamer temperature detected by the Steamer thermostat is $\geq 165^{\circ}\text{C}$.	The steamer could not pump water or too much scale.
ER08	Water tank motor error.	The water tank motor could not resume.

If the problem still persists, please contact Caple service for assistance:

Phone: **0117 938 7420**

Email: **service@caple.co.uk**



Caple Service
Fourth Way
Avonmouth
Bristol
BS11 8DW

T: 0117 938 1900
E: service@caple.co.uk
www.caple.co.uk