

# CPF120IGMPWH

Cooker size	120x60 cm
N. of cavities with energy label	2
Heat source first cavity	Electric
Hob type	Mixed
Type of main oven	Thermo-ventilated
Type of second oven	Thermo-ventilated
Cleaning system main oven	Pyrolytic
EAN code	8017709286071
Energy efficiency class	A+
Energy efficiency class, second cavity	A



## Aesthetics











<b>Aesthetics</b>	Portofino	<b>Display</b>	Touch
<b>Colour</b>	White	<b>No. of controls</b>	11
<b>Design</b>	Flush fit	<b>Serigraphy colour</b>	Black
<b>Door</b>	With frame	<b>Handle</b>	Smeg Portofino
<b>Upstand</b>	Yes	<b>Handle Colour</b>	White
<b>Type of pan stands</b>	Cast Iron	<b>Glass type</b>	Black
<b>Hob colour</b>	Stainless steel	<b>Plinth</b>	Black
<b>Command panel finish</b>	Enamelled metal	<b>Storage compartment</b>	Drawer
<b>Control knobs</b>	Smeg Portofino	<b>Logo</b>	Assembled st/steel
<b>Controls colour</b>	Stainless steel	<b>Logo position</b>	Facia below the oven

## Programme / Functions

No. of cooking functions	9
--------------------------	---

### Traditional cooking functions

- |                                                                                                                            |                                                                                                     |                                                                                                       |
|----------------------------------------------------------------------------------------------------------------------------|-----------------------------------------------------------------------------------------------------|-------------------------------------------------------------------------------------------------------|
|  Static                                    |  Fan assisted      |  Circulaire        |
|  Turbo (circulaire + bottom + upper + fan) |  ECO               |  Small grill       |
|  Large grill                               |  Fan grill (large) |  Fan assisted base |







### Cleaning functions

-  Pyrolytic

## Programs / Functions Auxiliary Oven

### Cooking functions cavity 2 8

#### Traditional cooking functions, cavity 2

- |                                                                                                        |                                                                                                  |                                                                                                         |
|--------------------------------------------------------------------------------------------------------|--------------------------------------------------------------------------------------------------|---------------------------------------------------------------------------------------------------------|
|  Static              |  Fan assisted |  Circulaire        |
|  ECO                 |  Large grill  |  Fan grill (large) |
|  Fan-assisted bottom |                                                                                                  |                                                                                                         |

#### Cooking functions with Direct Steam technology



Termo-ventilato (Circolare + Ventola)

#### Cleaning functions cavity 2

-  Vapor Clean

## Hob technical features



### Total no. of cook zones 6

Left centre - Gas - 2UR (dual) - 4.20 kW

Front centre - Gas - Semi Rapid - 1.80 kW

Rear centre - Gas - Rapid - 3.00 kW

Front right - Induction - multizone - 2.10 kW - Booster 2.30 kW - 21.1x19.1 cm

Rear right - Induction - multizone - 1.60 kW - Booster 1.85 kW - 21.0x19.0 cm

Central - Teppanyaki - 1.40 kW

<b>Type of gas burners</b>	Standard	<b>Automatic pan detection</b>	Yes
<b>Automatic electronic ignition</b>	Yes	<b>Minimum pan diameter indication</b>	Yes
<b>Burner caps</b>	Matt black enamelled	<b>Selected zone indicator</b>	Yes
<b>Automatic switch off when overheat</b>	Yes	<b>Residual heat indicator</b>	Yes

## Main Oven Technical Features



<b>No. of lights</b>	2	<b>Total no. of door glasses</b>	4
<b>Fan number</b>	1	<b>No. of thermo-reflective door glasses</b>	3
<b>Net volume of the cavity</b>	70 litres	<b>Safety Thermostat</b>	Yes
<b>Gross volume, 1st cavity</b>	79 l	<b>Heating suspended when door is opened</b>	Yes
<b>Cavity material</b>	Easy clean enamel	<b>Cooling system</b>	Tangential
<b>Shelf positions</b>	5	<b>Door Lock During Pyrolysis</b>	Yes
<b>Type of shelves</b>	Metal racks	<b>Usable cavity space dimensions (HxWxD)</b>	360X460X425 mm
<b>Light type</b>	Halogen	<b>Temperature control</b>	Electro-mechanical
<b>Light power</b>	40 W	<b>Lower heating element power</b>	1200 W
<b>Cooking time setting</b>	Start and Stop	<b>Upper heating element - Power</b>	1000 W
<b>Light when oven door is open</b>	Yes	<b>Grill element</b>	1700 W
<b>Door opening</b>	Flap down	<b>Large grill - Power</b>	2700 W
<b>Removable door</b>	Yes	<b>Circular heating element - Power</b>	2000 W
<b>Full glass inner door</b>	Yes	<b>Grill type</b>	Electric
<b>Removable inner door</b>	Yes	<b>Soft Close system</b>	Yes

## Options Main Oven

<b>Timer</b>	Yes	<b>Minimum Temperature</b>	30 °C
<b>End of cooking acoustic alarm</b>	Yes	<b>Maximum temperature</b>	280 °C

## Second Oven Technical Features



<b>Net volume of the second cavity</b>	63 litres	<b>No. thermo-reflective door glasses</b>	2
<b>Gross volume, 2nd cavity</b>	79 l	<b>Safety Thermostat</b>	Yes
<b>Cavity material</b>	Easy clean enamel	<b>Heating suspended when door is opened</b>	Yes
<b>Shelf positions</b>	5	<b>Cooling system</b>	Tangential

Type of shelves	Metal racks	Usable cavity space dimensions (HxWxD)	360X460X425 mm
No. of lights	2	Temperature control	Electro-mechanical
Light type	Halogen	Lower heating element - power	1200 W
Light power	40 W	Upper heating element - Power	1000 W
Cooking time setting	Start and Stop	Grill element - power	1700 W
Light when oven door is open	Yes	Large grill - Power	2700 W
Door opening	Flap down	Circular heating element - Power	2000 W
Removable door	Yes	Grill type	Electric
Full glass inner door	Yes	Tilting grill	Yes
Removable inner door	Yes	Soft Close system	Yes
No. total door glasses	3		

## Options Auxiliary Oven

Timer	Yes	Minimum Temperature	30 °C
End of cooking acoustic alarm	Yes	Maximum temperature	280 °C

## Accessories included for Main Oven & Hob



Top oven chrome shelf with back stop	1	40mm deep tray	1
Grill mesh	1	Telescopic Guide rails, partial Extraction	1
20mm deep tray	1	Meat Probe	1

## Accessories included for Secondary Oven



Chrome shelf with back and side stop	1	40mm deep tray	1
Grill mesh	1	Telescopic Guide rails, partial Extraction	1
20mm deep tray	1		

## Electrical Connection

Nominal power	10900 W	Frequency	50/60 Hz
Current	32 A	Cable testing	Yes
Voltage	220-240 V	Terminal block	5 poles
Voltage 2 (V)	380-415 V		

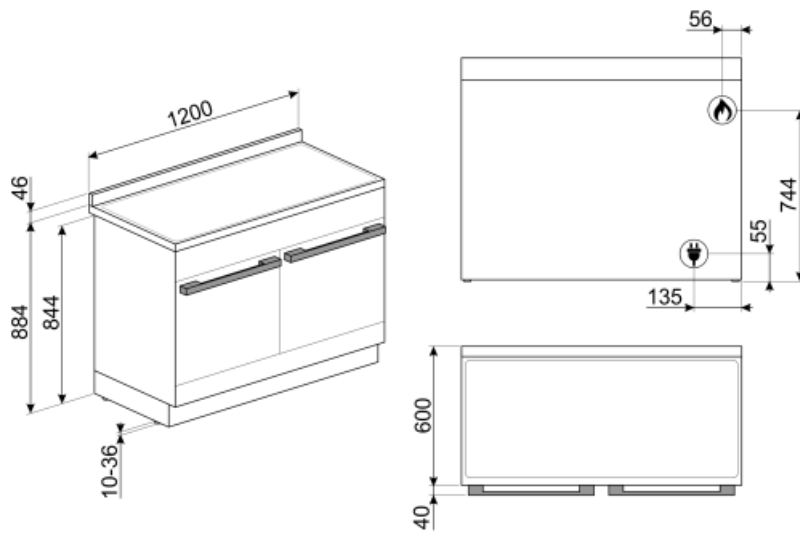

## Not included accessories



**SFLK1**  
Child lock



**PRTX**  
Refractory pizza stone with handles. D=35cm Not suitable for microwave ovens. Suitable for gas ovens, to be put on the griddle.



**WOKGHU**  
Cast-Iron WOK Support

**KIT1CPF120X**  
Splashback 120x60 cm, stainless steel, suitable for Portofino cookers

**KITH95CPF120**  
Height extension kit (950 mm), suitable for TR4110 cookers

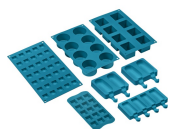

**SMOLD**  
Set of 7 silicone moulds for ice creams, ice lollies, pralines, ice cubes or to portion food. Usable from -60°C to +230°C



**GTP**  
\*\*Partially extractable telescopic guides (1 level)\*\* Extraction: 300 mm  
Material: Stainless steel AISI 430 polished

**KITP65CPF120**  
Depth extension kit (650 mm), suitable for TR4110 cookers



**PPR2**  
Refractory pizza stone without handles. Squared shaped stone: L42 x H1,8 x D37,5 cm. Suitable also for gas ovens, to be put on the griddle.



**BGTR4110**  
Cast iron grill plate suitable for Victoria Cookers TR4110



**GTT**  
\*\*Totally extractable telescopic guides (1 level)\*\* Extraction: 433 mm  
Material: Stainless steel AISI 430 polished

## Alternative products

---



CPF120IGMPX



CPF120IGMPR



































CPF120IGMPBL



CPF120IGMPT

## Symbols glossary

- A** A: Product drying performance, measured from A+++ to D / G depending on the product family
-  Heavy duty cast iron pan stands: for maximum stability and strength.
-  A DIRECT STEAM oven has 1 steam cooking function to which the user can MANUALLY add steam. The function is activated when the user turns the function knob to the STEAM ON position, and deactivated when the user turns the steam knob to the STEAM OFF position. The user decides at the start of the cooking process how much water to load, up to 250ml. The water in the cavity then becomes steam during the cooking process.
-  Quadruple glazed: Number of glazed doors.
-  Enamel interior: The enamel interior of all Smeg ovens have a special antacid lining which helps keep the interior clean by reducing the amount of cooking grease adhering to it.
-  Fan with upper and lower elements: The elements combined with the fan aim to provide more uniform heat, a similar method to conventional cooking, so pre-heat is required. Most suitable for items requiring slow cooking methods.
-  Circulaire: The combination of the fan and circular element around it gives a hot air cooking method. This provides many benefits including no preheat if cook time is more than 20 minutes, no flavour transfer when cooking different foods at the same time, less energy, and shorter cook times. Good for all types of food.
-  Grill element: Using of grill gives excellent results when cooking meat of medium and small portions, especially when combined with a rotisserie (where possible). Also ideal for cooking sausages and bacon.
- A+** A+: Energy efficiency class A+ helps to save up to 10% energy compared to class A. Maximum performance with minimum consumption is guaranteed.
-  Air cooling system: to ensure a safe surface temperatures.
-  Triple glazed doors: Number of glazed doors.
-  ECO-logic: option allows you to restrict the power limit of the appliance real energy saving.
-  Circogas: In gas ovens the fan distributes the heat quickly and evenly throughout the oven cavity, avoiding flavour transfer when cooking a number of different dishes at the same time. In electric ovens this combination completes cooking more quickly of foods that are ready on the surface, but that require more cooking inside, without further browning.
-  Upper and lower element only: a traditional cooking method best suited for single items located in the centre of the oven. the top of the oven will always be hottest. Ideal for roast, fruit cakes, bread etc.
-  ECO: The combination of the grill, fan and lower element is particularly suitable for cooking small quantities of food.
-  Half grill: For rapid cooking and browning of foods. Best results can be obtained by using the top shelf for small items, the lower shelves for larger ones, such as chops or sausages. For half grill heat is generated only at the centre of the element, so is ideal for smaller quantities.

- |                                                                                                                                                                                                                                                                                                                                                                                                                                                                                                                                                                                               |                                                                                                                                                                                                                                                                                                                                                                                                                                                |
|-----------------------------------------------------------------------------------------------------------------------------------------------------------------------------------------------------------------------------------------------------------------------------------------------------------------------------------------------------------------------------------------------------------------------------------------------------------------------------------------------------------------------------------------------------------------------------------------------|------------------------------------------------------------------------------------------------------------------------------------------------------------------------------------------------------------------------------------------------------------------------------------------------------------------------------------------------------------------------------------------------------------------------------------------------|
|  <p><b>Fan with grill element:</b> The fan reduces the fierce heat from the grill, providing an excellent method of grilling various foods, chops, steaks, sausages etc. giving even browning and heat distribution, without drying out the food. The top two levels recommended for use, and the lower part of the oven can be used to keep items warm at the same time, an excellent facility when cooking a grilled breakfast. Half grill (centre portion only) is ideal for small quantities of food.</p> |  <p><b>Circulaire with upper and lower elements:</b> The use of the fan with both elements allows food to be cooked quickly and effectively, ideal for large joints that require thorough cooking. It offers a similar result to rotisserie, moving the heat around the food, instead of moving the food itself, enabling any size or shape to be cooked.</p> |
|  <p><b>Circulaire with steam assist:</b> Provides extra moisture to food during cooking. Excellent for bread baking. The moisture allows the bread dough to stretch further at the beginning of cooking, creating an aerated and light textured dough. The remaining part of the cooking process allows for the signature crust to form.</p>                                                                                                                                                                  |  <p><b>Overheat protection:</b> The safety system that automatically turns off the hob in case of overheating of the control unit.</p>                                                                                                                                                                                                                        |
|  <p><b>All glass inner door:</b> All glass inner door, a single flat surface which is simple to keep clean.</p>                                                                                                                                                                                                                                                                                                                                                                                               |  <p><b>The inner door glass:</b> can be removed with a few quick movements for cleaning.</p>                                                                                                                                                                                                                                                                  |
|  <p><b>Side lights:</b> Two opposing side lights increase visibility inside the oven.</p>                                                                                                                                                                                                                                                                                                                                                                                                                    |  <p><b>Pyrolytic:</b> Pyrolytic cleaning cycles can be selected as necessary to automatically clean the oven interior.</p>                                                                                                                                                                                                                                   |
|  <p><b>Indication of residual heat:</b> After the glass ceramic hob is switched off the residual heat indicator shows which of the heating zones still remains hot. When the temperature drops below 60 ° C, the indicator goes out.</p>                                                                                                                                                                                                                                                                    |  <p><b>The oven cavity has 5 different cooking levels.</b></p>                                                                                                                                                                                                                                                                                              |
|  <p><b>Soft close:</b> all models are equipped with advanced function of smooth closing of the door, which allows the device to close smoothly and quietly.</p>                                                                                                                                                                                                                                                                                                                                             |  <p><b>Telescopic rails:</b> allow you to pull out the dish and check it without having to remove it from the oven entirely.</p>                                                                                                                                                                                                                            |
|  <p><b>Electronic control:</b> Allows you to maintain temperature inside the oven with the precision 2-3 ° C. This enables to cook meals that are very sensitive to temperature changes, such as cakes, souffles, puddings.</p>                                                                                                                                                                                                                                                                             |  <p><b>Tilting grill:</b> the tilting grill can be easily unhooked to move the heating element and clean the roof of the appliance in one simple step.</p>                                                                                                                                                                                                  |
|  <p><b>Ultra rapid burners:</b> Powerful ultra rapid burners offer up to 5kw of power.</p>                                                                                                                                                                                                                                                                                                                                                                                                                  |  <p><b>Vapor Clean:</b> a simple cleaning function using steam to loosen deposits in the oven cavity.</p>                                                                                                                                                                                                                                                   |
|  <p><b>The capacity indicates the amount of usable space in the oven cavity in litres.</b></p>                                                                                                                                                                                                                                                                                                                                                                                                              |  <p><b>The capacity indicates the amount of usable space in the oven cavity in litres.</b></p>                                                                                                                                                                                                                                                              |