

CPF120IGMPX

Cooker size	120x60 cm
N. of cavities with energy label	2
Heat source first cavity	Electric
Hob type	Mixed
Type of main oven	Thermo-ventilated
Type of second oven	Thermo-ventilated
Cleaning system main oven	Pyrolytic
EAN code	8017709278267
Energy efficiency class	A+
Energy efficiency class, second cavity	A



Aesthetics



Aesthetics	Portofino	Display	Touch
Colour	Stainless steel	No. of controls	11
Design	Flush fit	Serigraphy colour	Black
Door	With frame	Handle	Smeg Portofino
Upstand	Yes	Handle Colour	Brushed stainless steel
Type of pan stands	Cast Iron	Glass type	Black
Hob colour	Stainless steel	Plinth	Black
Command panel finish	Finger friendly stainless steel	Storage compartment	Drawer
Control knobs	Smeg Portofino	Logo	Assembled st/steel
Controls colour	Stainless steel	Logo position	Facia below the oven

Programme / Functions

No. of cooking functions	9
--------------------------	---

Traditional cooking functions



Static



Fan assisted



Circulaire



Turbo (circulaire + bottom + upper + fan)



ECO



Small grill



Large grill



Fan grill (large)



Fan assisted base

Cleaning functions



Pyrolytic

Programs / Functions Auxiliary Oven

Cooking functions cavity 2

8

Traditional cooking functions, cavity 2



Static



Fan assisted



Circulaire



ECO



Large grill



Fan grill (large)



Fan-assisted bottom

Cooking functions with Direct Steam technology



Termo-ventilato (Circolare + Ventola)

Cleaning functions cavity 2



Vapor Clean

Hob technical features



Total no. of cook zones 6

Left centre - Gas - 2UR (dual) - 4.20 kW

Front centre - Gas - Semi Rapid - 1.80 kW

Rear centre - Gas - Rapid - 3.00 kW

Front right - Induction - multizone - 2.10 kW - Booster 2.30 kW - 21.1x19.1 cm

Rear right - Induction - multizone - 1.60 kW - Booster 1.85 kW - 21.0x19.0 cm

Central - Teppanyaki - 1.40 kW

Type of gas burners	Standard	Automatic pan detection	Yes
Automatic electronic ignition	Yes	Minimum pan diameter indication	Yes
Burner caps	Matt black enamelled	Selected zone indicator	Yes
Automatic switch off when overheat	Yes	Residual heat indicator	Yes

Main Oven Technical Features



No. of lights	2	Total no. of door glasses	4
Fan number	1	No. of thermo-reflective door glasses	3
Net volume of the cavity	70 litres	Safety Thermostat	Yes
Gross volume, 1st cavity	79 l	Heating suspended when door is opened	Yes
Cavity material	Easy clean enamel	Cooling system	Tangential
Shelf positions	5	Door Lock During Pyrolysis	Yes
Type of shelves	Metal racks	Usable cavity space dimensions (HxWxD)	360X460X425 mm
Light type	Halogen	Temperature control	Electro-mechanical
Light power	40 W	Lower heating element power	1200 W
Cooking time setting	Start and Stop	Upper heating element - Power	1000 W
Light when oven door is open	Yes	Grill element	1700 W
Door opening	Flap down	Large grill - Power	2700 W
Removable door	Yes	Circular heating element - Power	2000 W
Full glass inner door	Yes	Grill type	Electric
Removable inner door	Yes	Soft Close system	Yes

Options Main Oven

Timer	Yes	Minimum Temperature	30 °C
End of cooking acoustic alarm	Yes	Maximum temperature	280 °C

Second Oven Technical Features



Net volume of the second cavity	63 litres	No. thermo-reflective door glasses	2
Gross volume, 2nd cavity	79 l	Safety Thermostat	Yes
Cavity material	Easy clean enamel	Heating suspended when door is opened	Yes
Shelf positions	5	Cooling system	Tangential

Type of shelves	Metal racks	Usable cavity space dimensions (HxWxD)	360X460X425 mm
No. of lights	2	Temperature control	Electro-mechanical
Light type	Halogen	Lower heating element - power	1200 W
Light power	40 W	Upper heating element - Power	1000 W
Cooking time setting	Start and Stop	Grill element - power	1700 W
Light when oven door is open	Yes	Large grill - Power	2700 W
Door opening	Flap down	Circular heating element - Power	2000 W
Removable door	Yes	Grill type	Electric
Full glass inner door	Yes	Tilting grill	Yes
Removable inner door	Yes	Soft Close system	Yes
No. total door glasses	3		

Options Auxiliary Oven

Timer	Yes	Minimum Temperature	30 °C
End of cooking acoustic alarm	Yes	Maximum temperature	280 °C

Accessories included for Main Oven & Hob



Top oven chrome shelf with back stop	1	40mm deep tray	1
Grill mesh	1	Telescopic Guide rails, partial Extraction	1
20mm deep tray	1	Meat Probe	1

Accessories included for Secondary Oven



Chrome shelf with back and side stop	1	40mm deep tray	1
Grill mesh	1	Telescopic Guide rails, partial Extraction	1
20mm deep tray	1		

Electrical Connection

Nominal power	10900 W	Frequency	50/60 Hz
Current	32 A	Cable testing	Yes
Voltage	220-240 V	Terminal block	5 poles
Voltage 2 (V)	380-415 V		

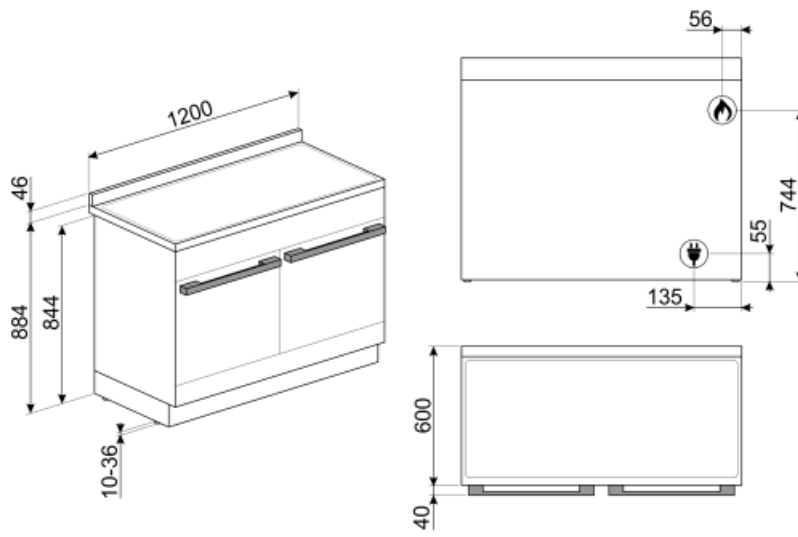

Not included accessories



SFLK1
Child lock



PRTX
Refractory pizza stone with handles. D=35cm Not suitable for microwave ovens. Suitable for gas ovens, to be put on the griddle.



WOKGHU
Cast-Iron WOK Support

KIT1CPF120X
Splashback 120x60 cm, stainless steel, suitable for Portofino cookers

KITH95CPF120
Height extension kit (950 mm), suitable for TR4110 cookers

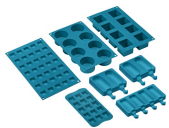

SMOLD
Set of 7 silicone moulds for ice creams, ice lollies, pralines, ice cubes or to portion food. Usable from -60°C to +230°C



GTP
Partially extractable telescopic guides (1 level) Extraction: 300 mm
Material: Stainless steel AISI 430 polished

KITP65CPF120
Depth extension kit (650 mm), suitable for TR4110 cookers



PPR2
Refractory pizza stone without handles. Squared shaped stone: L42 x H1,8 x D37,5 cm. Suitable also for gas ovens, to be put on the griddle.



BGTR4110
Cast iron grill plate suitable for Victoria Cookers TR4110



GTT
Totally extractable telescopic guides (1 level) Extraction: 433 mm
Material: Stainless steel AISI 430 polished

Alternative products



CPF120IGMPWH



CPF120IGMPR





































CPF120IGMPBL



CPF120IGMPT

Symbols glossary

-  A: Product drying performance, measured from A+++ to D / G depending on the product family
-  Heavy duty cast iron pan stands: for maximum stability and strength.
-  A DIRECT STEAM oven has 1 steam cooking function to which the user can MANUALLY add steam. The function is activated when the user turns the function knob to the STEAM ON position, and deactivated when the user turns the steam knob to the STEAM OFF position. The user decides at the start of the cooking process how much water to load, up to 250ml. The water in the cavity then becomes steam during the cooking process.
-  Quadruple glazed: Number of glazed doors.
-  Enamel interior: The enamel interior of all Smeg ovens have a special antacid lining which helps keep the interior clean by reducing the amount of cooking grease adhering to it.
-  Circogas: In gas ovens the fan distributes the heat quickly and evenly throughout the oven cavity, avoiding flavour transfer when cooking a number of different dishes at the same time. In electric ovens this combination completes cooking more quickly of foods that are ready on the surface, but that require more cooking inside, without further browning.
-  Upper and lower element only: a traditional cooking method best suited for single items located in the centre of the oven. the top pf the oven will always be hottest. Ideal for roast, fruit cakes, bread etc.
-  ECO: The combination of the grill, fan and lower element is particularly suitable for cooking small quantities of food.
-  A+: Energy efficiency class A+ helps to save up to 10% energy compared to class A. Maximum performance with minimum consumption is guaranteed.
-  Air cooling system: to ensure a safe surface temperatures.
-  Triple glazed doors: Number of glazed doors.
-  ECO-logic: option allows you to restrict the power limit of the appliance real energy saving.
-  Fingerprint proof stainless steel: Fingerprint proof stainless steel keeps stainless steel looking as good as new.
-  Fan with upper and lower elements: The elements combined with the fan aim to provide more uniform heat, a similar method to conventional cooking, so pre-heat is required. Most suitable for items requiring slow cooking methods.
-  Circulaire: The combination of the fan and circular element around it gives a hot air cooking method. This provides many benefits including no preheat if cook time is more than 20 minutes, no flavour transfer when cooking different foods at the same time, less energy, and shorter cook times. Good for all types of food.
-  Grill element: Using of grill gives excellent results when cooking meat of medium and small portions, especially when combined with a rotisserie (where possible). Also ideal for cooking sausages and bacon.

-  Half grill: For rapid cooking and browning of foods. Best results can be obtained by using the top shelf for small items, the lower shelves for larger ones, such as chops or sausages. For half grill heat is generated only at the centre of the element, so is ideal for smaller quantities.
-  Circulaire with upper and lower elements: The use of the fan with both elements allows food to be cooked quickly and effectively, ideal for large joints that require thorough cooking. It offers a similar result to rotisserie, moving the heat around the food, instead of moving the food itself, enabling any size or shape to be cooked.
-  Overheat protection: The safety system that automatically turns off the hob in case of overheating of the control unit.
-  The inner door glass: can be removed with a few quick movements for cleaning.
-  Pyrolytic: Pyrolytic cleaning cycles can be selected as necessary to automatically clean the oven interior.
-  The oven cavity has 5 different cooking levels.
-  Telescopic rails: allow you to pull out the dish and check it without having to remove it from the oven entirely.
-  Tilting grill: the tilting grill can be easily unhooked to move the heating element and clean the roof of the appliance in one simple step.
-  Vapor Clean: a simple cleaning function using steam to loosen deposits in the oven cavity.
-  The capacity indicates the amount of usable space in the oven cavity in litres.
-  Fan with grill element: The fan reduces the fierce heat from the grill, providing an excellent method of grilling various foods, chops, steaks, sausages etc. giving even browning and heat distribution, without drying out the food. The top two levels recommended for use, and the lower part of the oven can be used to keep items warm at the same time, an excellent facility when cooking a grilled breakfast. Half grill (centre portion only) is ideal for small quantities of food.
-  Circulaire with steam assist: Provides extra moisture to food during cooking. Excellent for bread baking. The moisture allows the bread dough to stretch further at the beginning of cooking, creating an aerated and light textured dough. The remaining part of the cooking process allows for the signature crust to form.
-  All glass inner door: All glass inner door, a single flat surface which is simple to keep clean.
-  Side lights: Two opposing side lights increase visibility inside the oven.
-  Indication of residual heat: After the glass ceramic hob is switched off the residual heat indicator shows which of the heating zones still remains hot. When the temperature drops below 60 ° C, the indicator goes out.
-  Soft close: all models are equipped with advanced function of smooth closing of the door, which allows the device to close smoothly and quietly.
-  Electronic control: Allows you to maintain temperature inside the oven with the precision 2-3 ° C. This enables to cook meals that are very sensitive to temperature changes, such as cakes, souffles, puddings.
-  Ultra rapid burners: Powerful ultra rapid burners offer up to 5kw of power.
-  The capacity indicates the amount of usable space in the oven cavity in litres.