

CVI321X3



Product Family	Wine Cooler
Installation	Built-in
Built-In Niche	45 cm
Defrost	Automatic
Cooling type	Fan assisted
Hinge type	Standard
Hinge position	Right
Reversible door	Yes



Wine cooler compartment features



Number of fixed shelves	1
Number of removable shelves	2
Shelves material	Wood
Removable shelves on telescopic guide rails	Yes
Type of internal light	LED
Air filter	Activated charcoal filter

Programs / Functions



Control setting	Touch control	Control lock	Yes
Controls	Internal, in the compartment	Lighting forced ON	In a maximum period
Display	LED	Fan forced ON	Yes
Functions display	Temperature alarm, Temperature value	Temperature Alarm	Yes
Power on lamp	Yes	Door open alarm	Yes

Technical Features

Adjustable temperature zones	1	Number of compressors	1
Independent cooling systems	1	Compressor type	Low vibration compressor
Number of door glasses	2	Refrigerant gas type	R600a

Temperature range	5-20 °C	Refrigerant Quantity (gr)	20 g
Type of temperature control	Electronic	Foam agent	HFO
Anti-UV door glass	Yes	Metal panel on the back of the fridge	Metal
Integrated heating element	Yes	Door opening type	With push pull system

Performance / Energy Label







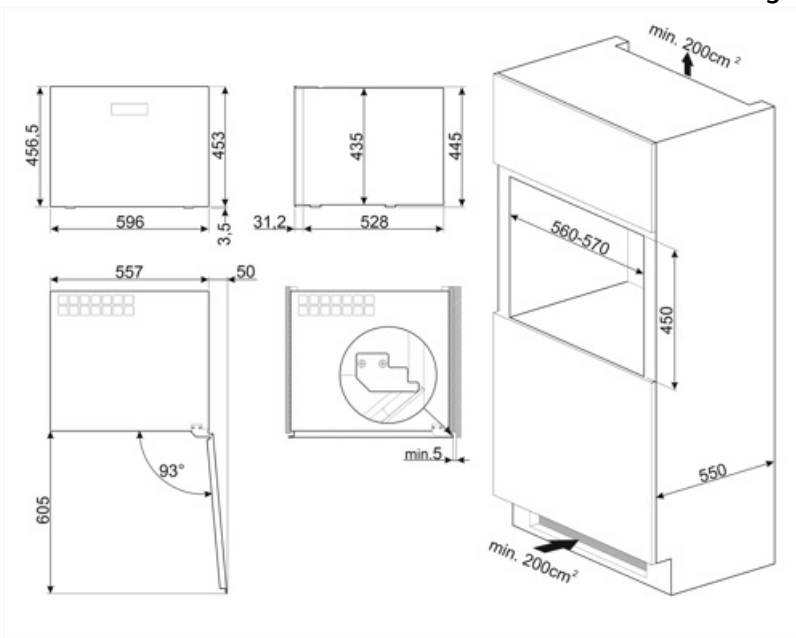

			
Max Capacity (bottles 0,75lt)	21	Sum of the volumes of the chill compartment(s) and the unfrozen compartment(s)	56 l
Annual energy consumption	100 kWh/year	Climatic class	SN, N, ST
Energy efficiency class	F	EEl	124 %
Airborne acoustical noise emission class	C	Noise level	36 dB(A) re 1 pW
Total volume	56 l		

Electrical Connection

Plug	(F;E) Schuko	Voltage (V)	220-240 V
Nominal power	40 W	Frequency (Hz)	50 Hz
Current	0,4 A	Power supply cable length	180 cm



Symbols glossary

-  The automatic defrost system works by automatically defrosting at regular intervals eliminating the need to defrost altogether.
-  Energy efficiency class F
-  Ventilated: Forced distribution of cold air in the refrigerator compartment, which allows even temperature distribution within the fridge.
-  LED interior lighting: is a more energy efficient and long lasting way of illuminating the interior of the appliance.
-  Touch controls: Easy to use touch controls allow the appliance to be programmed at the touch of a button.
-  A+: Energy efficiency class A+ helps to save up to 10% energy compared to class A. Maximum performance with minimum consumption is guaranteed.
-  LED display: to show programmes, functions and options selected and the time to the end of the cycle.
-  Fingerprint proof stainless steel: Fingerprint proof stainless steel keeps stainless steel looking as good as new.
-  Built-in niche

Benefit

Reversible door

Reversible door for easy and versatile installation in any kitchen

Push-pull opening system

Push-pull opening system for easy opening and closing when needed, with the simple pressure of the surface at the end of the door

UV-protected door glass

The UV-protected door glass protects the bottles from the passage of light into the wine cooler for impeccable storage

LED lights

LED lights ensure perfect multi-level visibility inside the wine cooler

Activated charcoal air filter

The activated charcoal air filter ensures excellent quality of the air and is easy to maintain

Touch Display

Touch display for an easy and accurate temperature management inside the refrigerated compartment

Low-vibration compressor

The low-vibration compressor avoids exposing the bottles to prolonged vibrations, which could compromise the quality of the wine

Telescopic guides

Telescopic sliding guides for easy extraction of wine bottles