

CX103GMBL

Cooker size	100x60 cm
N. of cavities with energy label	2
Cavity heat source	Electric
Hob type	Gas
Type of main oven	Thermo-ventilated
Type of second oven	Thermo-ventilated
EAN code	8017709336622
Energy efficiency class	A
Energy efficiency class, second cavity	B



Aesthetics



Design	Standard	Control knobs	Smeg Classic
Command panel finish	Enamelled metal	Controls colour	Stainless steel
Aesthetics	Classic	No. of controls	8
Logo	Assembled	Serigraphy colour	Silver
Colour	Black	Display	Touch
Logo position	Command panel	Door	With frame
Finishing	Gloss Black	Glass type	Black
Series	Concert	Handle	Smeg Classic
Hob colour	Black enamel	Handle Colour	Brushed stainless steel
Type of pan stands	Cast Iron	Feet	none
Type of control setting	Control knobs	Plinth	Black

Programs / Functions

No. of cooking functions	4
Traditional cooking functions	



Circulaire



Small grill



Large grill



Fan grill (large)

Programs / Functions Auxiliary Oven

Cooking functions cavity 2 1

Traditional cooking functions, cavity 2

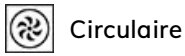

Programme / Functions Third Oven

No. of functions third oven 1

Full grill 

Hob technical features



Total no. of cook zones 5

Left centre - Gas - 2UR (dual) - 4.20 kW

Rear centre - Gas - Semi Rapid - 1.80 kW

Front centre - Gas - AUX - 1.00 kW

Rear right - Gas - Rapid - 2.90 kW

Front right - Gas - Semi Rapid - 1.80 kW

Type of gas burners Standard

Gas safety valves Yes

Automatic electronic ignition Yes

Burner caps

Matte black enamelled

Main Oven Technical Features



No. of lights 1

Fan number 1

Net volume of the cavity 61 litres

Gross volume, 1st cavity 70 l

Cavity material Easy clean enamel

Shelf positions 4

Type of shelves Metal racks

Light type Halogen

Light power 40 W

Cooking time setting Start and Stop

Door opening Side opening

Removable door Yes

Full glass inner door Yes

Removable inner door Yes

Total no. of door glasses 3

No. of thermo-reflective door glasses 1

Safety Thermostat Yes

Cooling system Tangential

Usable cavity space dimensions (HxWxD) 316x460x412 mm

Temperature control Electro-mechanical

Circular heating element - Power 2000 W

Options Main Oven

Timer Yes

End of cooking acoustic alarm Yes

Minimum Temperature 50 °C

Maximum temperature 245 °C

Second Oven Technical Features



Fan number	2	Removable door	Yes
Net volume of the second cavity	84 litres	Full glass inner door	Yes
Gross volume, 2nd cavity	94 l	No. total door glasses	2
Cavity material	Easy clean enamel	No. thermo-reflective door glasses	1
Shelf positions	9	Safety Thermostat	Yes
Type of shelves	Metal racks	Cooling system	Tangential
No. of lights	1	Usable cavity space dimensions (HxWxD)	605x275x370 mm
Light type	Halogen	Temperature control	Electro-mechanical
Light power	40 W	Circular heating element - Power	2500 W
Door opening	Side opening		

Options Auxiliary Oven

Minimum Temperature	50 °C	Maximum temperature	245 °C
----------------------------	-------	----------------------------	--------

Third Oven Technical Features



Net volume, 3rd cavity	35 l	Removable inner door	Yes
Gross volume, 3rd cavity	41 l	No. total door glasses	3
Cavity material	Easy clean enamel	No. of thermo-reflective door glasses	1
Shelf positions	2	Safety Thermostat	Yes
Type of shelves	Metal racks	Cooling system	Tangential
No. of lights	1	Usable cavity space dimensions (HxWxD)	169x440x443 mm
Light type	Halogen	Temperature control	Electro-mechanical
Light power	40 W	Large grill - Power	2700 W
Door opening	Flap down	Grill type	Electric
Removable door	Yes	Tilting grill	Yes
Full glass inner door	Yes		

Options Third Oven

Minimum Temperature	50 °C	Maximum temperature	260 °C
----------------------------	-------	----------------------------	--------

Accessories included for Main Oven & Hob

Chrome shelf with back and side stop	1	40mm deep tray	1
---	---	-----------------------	---

Accessories included for Secondary Oven

Chrome shelf with back stop 3

Accessories included for Third Oven

Chrome shelf with back and side stop 1

40mm deep tray 1

Electrical Connection

Max Power Draw 8600 W
 Current 38 A
 Voltage 220-240 V
 Voltage 2 (V) 380-415 V
 Type of electric cable Yes, Single phase

Additional connection modalities Yes, Double and Three Phase
 Frequency 50/60 Hz
 Terminal block 5 poles
 Plug No

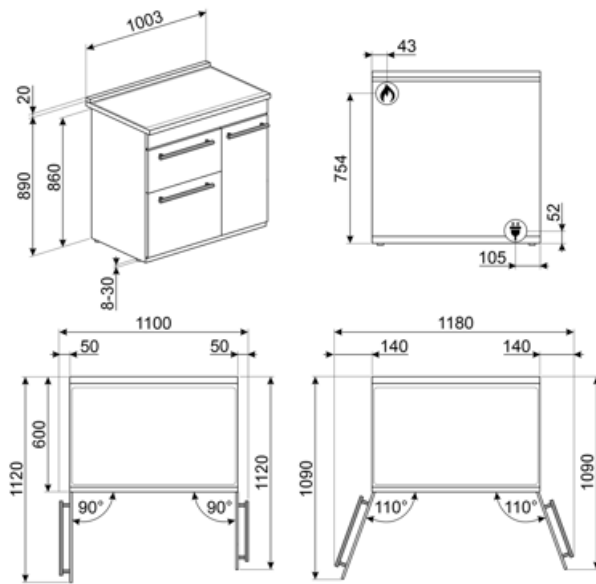

Compatible Accessories

AIRFRY

Air fryer rack AIRFRY. Ideal for recreating traditional frying in the oven, but with fewer calories and less fat. It allows you to cook quickly and simply dishes such as French fries, fried vegetables and fish, ensuring perfect browning and crispiness.



BBQ

Double sided plate BBQ. Suitable for recreating succulent and crispy dishes in the oven with the typical taste of grilled cooking. The ribbed side is particularly suitable for meats and cheeses. The smooth side for fish, seafood and vegetables.



BN640

Enamelled tray, 40mm deep



GRM

Gas hobs moka support



GTT

Totally extractable telescopic guides (1 level) Extraction: 433 mm Material: Stainless steel AISI 430 polished



KITH93

Height extension kit (950 mm), suitable for TR93 cookers



SFLK1

Child lock



AIRFRY2

Air fryer tray. Ideal for recreating traditional frying in the oven, but with fewer calories and less fat. It allows you to cook quickly and simply dishes such as French fries, fried vegetables and fish, ensuring perfect browning and crispiness.



BN620-1

Enamelled tray, 20mm deep



BNP608T

Teflon-coated tray, 8mm depth, to be placed on the grid



GTP

Partially extractable telescopic guides (1 level) Extraction: 300 mm Material: Stainless steel AISI 430 polished



KIT90N9

Splashback 90 cm, black, for BU & BM cookers



PALPZ

Pizza shovel with fold away handle width: 315mm length : 325mm



SMOLD

Set of 7 silicone moulds for ice creams, ice lollies, pralines, ice cubes or to portion food. Usable from -60°C to +230°C

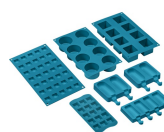





























WOKGHU

Cast-Iron WOK Support



Symbols glossary

 <p>A: Product drying performance, measured from A+++ to D / G depending on the product family</p>	 <p>B: Product energy rating, measured from A+++ to D / G depending on the product family.</p>
 <p>Heavy duty cast iron pan stands: for maximum stability and strength.</p>	 <p>Installation in column: Installation in column</p>
 <p>Air cooling system: to ensure a safe surface temperatures.</p>	 <p>Double glazed doors: Number of glazed doors.</p>
 <p>Triple glazed doors: Number of glazed doors.</p>	 <p>Enamel interior: The enamel interior of all Smeg ovens have a special antacid lining which helps keep the interior clean by reducing the amount of cooking grease adhering to it.</p>
 <p>Circulaire: The combination of the fan and circular element around it gives a hot air cooking method. This provides many benefits including no preheat if cook time is more than 20 minutes, no flavour transfer when cooking different foods at the same time, less energy, and shorter cook times. Good for all types of food.</p>	 <p>Grill element: Using of grill gives excellent results when cooking meat of medium and small portions, especially when combined with a rotisserie (where possible). Also ideal for cooking sausages and bacon.</p>
 <p>Grill element: Using of grill gives excellent results when cooking meat of medium and small portions, especially when combined with a rotisserie (where possible). Also ideal for cooking sausages and bacon.</p>	 <p>Half grill: For rapid cooking and browning of foods. Best results can be obtained by using the top shelf for small items, the lower shelves for larger ones, such as chops or sausages. For half grill heat is generated only at the centre of the element, so is ideal for smaller quantities.</p>
 <p>Fan with grill element: The fan reduces the fierce heat from the grill, providing an excellent method of grilling various foods, chops, steaks, sausages etc. giving even browning and heat distribution, without drying out the food. The top two levels recommended for use, and the lower part of the oven can be used to keep items warm at the same time, an excellent facility when cooking a grilled breakfast. Half grill (centre portion only) is ideal for small quantities of food.</p>	 <p>Light</p>
 <p>All glass inner door: All glass inner door, a single flat surface which is simple to keep clean.</p>	 <p>The inner door glass: can be removed with a few quick movements for cleaning.</p>
 <p>Side lights: Two opposing side lights increase visibility inside the oven.</p>	 <p>The oven cavity has 2 different cooking levels.</p>
 <p>The oven cavity has 4 different cooking levels.</p>	 <p>The oven cavity has 9 different cooking levels.</p>
 <p>Electronic control: Allows you to maintain temperature inside the oven with the precision 2-3 ° C. This enables to cook meals that are very sensitive to temperature changes, such as cakes, souffles, puddings.</p>	 <p>Tilting grill: the tilting grill can be easily unhooked to move the heating element and clean the roof of the appliance in one simple step.</p>

-
-  Ultra rapid burners: Powerful ultra rapid burners offer up to 5kw of power.
 -  The capacity indicates the amount of usable space in the oven cavity in litres.
 -  The touch timer display or DigiScreen guarantees simple functionality. They display the time, set programmed cooking and the minute minder timer.
 -  The capacity indicates the amount of usable space in the oven cavity in litres.
 -  The capacity indicates the amount of usable space in the oven cavity in litres.
 -  Knobs control

Benefit

Gas hob

Gas provides constant control of the heat source, with an immediate change in temperature

Equipped with a thermocouple, the gas supply is cut off if the flame is extinguished for greater safety

Ever Clean Enamel

Easy oven cleaning thanks to the special antacid lining which helps to reduce the amount of dirt adhering to the surface.

Touch control

Easy and intuitive timer setting with a single touch

Circulaire

The best cooking performances guaranteed by ventilated circular flow.

Multiple fans and heating elements guarantee the perfect aerodynamic heat flow, allowing homogeneous and quicker cooking inside the cavity.

Multilevel cooking

Several cooking levels allow maximum flexibility of use

Multilevel halogen light

Internal halogen lighting on different levels guarantees excellent visibility

Removable inner glass

Internal door glasses are easily removable for complete cleaning

Tangential cooling

New cooling system with tangential fan and airflow from the door to the splashback

Adjustable height

Cooker top flushed with the working area thanks to adjustable feet

Isothermic Cavity

The best cooking performance at the highest energy efficiency

Cold door

During any function, the external door glass is cold, avoiding any risk of burns

AirFry (AIRFRY optional accessory)

Lighter and tastier food thanks to airfry basket

BBQ (optional accessory)

Barbeque cooking directly in the oven with the double-sided grill

Pizza stone (optional accessory)

Baking with refractory stone for soft and crispy pizza and yeast products (STONE optional accessory)

Single turbine

The oven has a fan equipped with a circular heating element allowing cooking with rotating heat