

CX61GMBL

Cooker size	60x60 cm
N. of cavities with energy label	1
Cavity heat source	Electric
Hob type	Gas
Type of main oven	Thermo-ventilated
Cleaning system main oven	Vapor Clean
EAN code	8017709336646
Energy efficiency class	A



Aesthetics











Design	Standard	Type of control setting	Control knobs
Command panel finish	Stainless steel	Control knobs	Smeg Classic
Aesthetics	Classic	Controls colour	Stainless steel
Logo	Embossed	No. of controls	7
Colour	Black	Serigraphy colour	Black
Logo position	Facia below the oven	Door	Full glass
Finishing	Gloss Black	Glass type	Black
Series	Concert	Handle	Smeg Classic
Hob colour	Black enamel	Handle Colour	Brushed stainless steel
Type of pan stands	Matte black enamelled flat	Feet	Black

Programs / Functions

No. of cooking functions	8
--------------------------	---

Traditional cooking functions

 Static	 Turbo (circulaire + bottom + upper + fan)	 ECO
 Small grill	 Large grill	 Fan grill (large)
 Base	 Pizza	









Cleaning functions

 Vapor Clean
--

Hob technical features

			
Total no. of cook zones	4		
Front left - Gas - UR	3.50 kW		
Rear left - Gas - Semi Rapid	1.75 kW		
Rear right - Gas - Semi Rapid	1.75 kW		
Front right - Gas - AUX	1.00 kW		
Type of gas burners	Standard	Gas safety valves	Yes
Automatic electronic ignition	Yes	Burner caps	Matte black enamelled

Main Oven Technical Features

								
No. of lights	1	Removable inner door	Yes					
Fan number	1	Total no. of door glasses	3					
Net volume of the cavity	70 litres	No. of thermo-reflective door glasses	1					
Gross volume, 1st cavity	79 l	Safety Thermostat	Yes					
Cavity material	Easy clean enamel	Cooling system	Tangential					
Shelf positions	5	Usable cavity space dimensions (HxWxD)	360X460X425 mm					
Type of shelves	Metal racks	Temperature control	Electro-mechanical					
Light type	Halogen	Lower heating element power	1200 W					
Light power	40 W	Upper heating element - Power	1000 W					
Cooking time setting	Timer + end of cooking	Grill element	1700 W					
Door opening	Flap down	Large grill - Power	2700 W					
Removable door	Yes							
Full glass inner door	Yes							

Circular heating element 2000 W
 - Power
 Grill type Electric

Options Main Oven

End of cooking acoustic alarm Yes
 Maximum temperature 260 °C
 Minimum Temperature 50 °C

Accessories included for Main Oven & Hob

Chrome shelf with back and side stop 1
 40mm deep tray 1

Electrical Connection

Max Power Draw 3000 W
 Current 13 A
 Voltage 220-240 V
 Type of electric cable Yes, Single phase
 Power supply cable length 115 cm
 Frequency 50/60 Hz
 Terminal block 3 poles
 Plug No

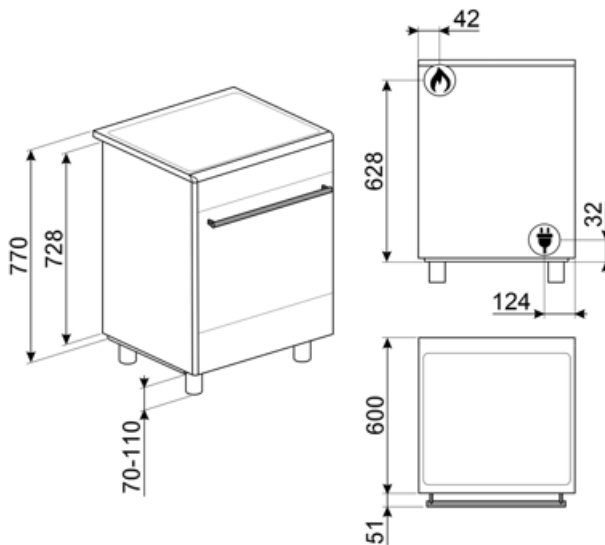

Compatible Accessories

AIRFRY

Air fryer rack AIRFRY. Ideal for recreating traditional frying in the oven, but with fewer calories and less fat. It allows you to cook quickly and simply dishes such as French fries, fried vegetables and fish, ensuring perfect browning and crispiness.



AL60

Upstand suitable for 60 cm Concert cookers with gas hob



BN620-1

Enamelled tray, 20mm deep



BNP608T

Teflon-coated tray, 8mm depth, to be placed on the grid



GTT

Totally extractable telescopic guides (1 level) Extraction: 433 mm Material: Stainless steel AISI 430 polished



KITPAX

High extension feet (950 mm), stainless steel, suitable for Master, Symphony and Concertcookers



PALPZ

Pizza shovel with fold away handle width: 315mm length: 325mm



SMOLD

Set of 7 silicone moulds for ice creams, ice lollies, pralines, ice cubes or to portion food. Usable from -60°C to +230°C

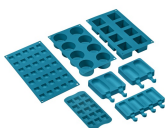

AIRFRY2

Air fryer tray. Ideal for recreating traditional frying in the oven, but with fewer calories and less fat. It allows you to cook quickly and simply dishes such as French fries, fried vegetables and fish, ensuring perfect browning and crispiness.



BBQ

Double sided plate BBQ. Suitable for recreating succulent and crispy dishes in the oven with the typical taste of grilled cooking. The ribbed side is particularly suitable for meats and cheeses. The smooth side for fish, seafood and vegetables.



BN640

Enamelled tray, 40mm deep

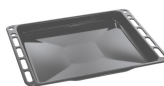

GTP

Partially extractable telescopic guides (1 level) Extraction: 300 mm Material: Stainless steel AISI 430 polished



KITP60X9

Splashback, 90 cm, stainless steel, suitable for pyrolytic Concert cookers



KITPD

High extension black feet (950 mm) for cookers



SFLK1

Child lock























STONE

Rectangular refractory stone. Ideal for cooking pizzas with the same results as a typical wood-fired oven. Can also be used for baking bread, focaccias and other recipes such as pies, flans or biscuits Dimensions: L42 x H1,8 x P37,5 cm.



Symbols glossary

 <p>A: Product drying performance, measured from A+++ to D / G depending on the product family</p>	 <p>Installation in column: Installation in column</p>
 <p>Air cooling system: to ensure a safe surface temperatures.</p>	 <p>Triple glazed doors: Number of glazed doors.</p>
 <p>Enamel interior: The enamel interior of all Smeg ovens have a special antacid lining which helps keep the interior clean by reducing the amount of cooking grease adhering to it.</p>	 <p>Upper and lower element only: a traditional cooking method best suited for single items located in the centre of the oven. the top pf the oven will always be hottest. Ideal for roast, fruit cakes, bread etc.</p>
 <p>Lower heating element only: This function is ideal for foods that require extra base temperature without browning, e.g. pastry dishes, pizza. Also suitable for slow cooking of stews and casseroles.</p>	 <p>ECO: The combination of the grill, fan and lower element is particularly suitable for cooking small quantities of food.</p>
 <p>Grill element: Using of grill gives excellent results when cooking meat of medium and small portions, especially when combined with a rotisserie (where possible). Also ideal for cooking sausages and bacon.</p>	 <p>Half grill: For rapid cooking and browning of foods. Best results can be obtained by using the top shelf for small items, the lower shelves for larger ones, such as chops or sausages. For half grill heat is generated only at the centre of the element, so is ideal for smaller quantities.</p>
 <p>Fan with grill element: The fan reduces the fierce heat from the grill, providing an excellent method of grilling various foods, chops, steaks, sausages etc. giving even browning and heat distribution, without drying out the food. The top two levels recommended for use, and the lower part of the oven can be used to keep items warm at the same time, an excellent facility when cooking a grilled breakfast. Half grill (centre portion only) is ideal for small quantities of food.</p>	 <p>Pizza function: The simultaneous operation of three elements ensures an optimum cooking facility when used with the Smeg pizza stone.</p>
 <p>Circulaire with upper and lower elements: The use of the fan with both elements allows food to be cooked quickly and effectively, ideal for large joints that require thorough cooking. It offers a similar result to rotisserie, moving the heat around the food, instead of moving the food itself, enabling any size or shape to be cooked.</p>	 <p>All glass inner door: All glass inner door, a single flat surface which is simple to keep clean.</p>
 <p>The inner door glass: can be removed with a few quick movements for cleaning.</p>	 <p>Side lights: Two opposing side lights increase visibility inside the oven.</p>
 <p>Automatic opening: some models have Automatic opening door when the cycle is finished which is a perfect solution for handle-less kitchen units as no handle is needed. For safety reasons, the door locks automatically when the machine is in use to avoid it being opened inadvertently.</p>	 <p>The oven cavity has 5 different cooking levels.</p>
 <p>Ultra rapid burners: Powerful ultra rapid burners offer up to 5kw of power.</p>	 <p>Vapor Clean: a simple cleaning function using steam to loosen deposits in the oven cavity.</p>



The capacity indicates the amount of usable space in the oven cavity in litres.



Knobs control