

CX91GMBL

Cooker size	90x60 cm
N. of cavities with energy label	1
Cavity heat source	Electric
Hob type	Gas
Type of main oven	Thermo-ventilated
Cleaning system main oven	Vapor Clean
EAN code	8017709329501
Energy efficiency class	A









Aesthetics



Design	Standard	Type of control setting	Control knobs
Command panel finish	Enamelled metal	Control knobs	Smeg Classic
Aesthetics	Classic	Controls colour	Stainless steel
Logo	Embossed	No. of controls	8
Colour	Black	Serigraphy colour	Black
Logo position	Facia below the oven	Door	Full glass
Finishing	Gloss Black	Glass type	Black
Series	Concert	Handle	Smeg Classic
Hob colour	Black enamel	Handle Colour	Brushed stainless steel
Type of pan stands	Matte black enamelled flat	Feet	Black

Programs / Functions

No. of cooking functions	6
Traditional cooking functions	

 Static	 Fan assisted	 Turbo (circulaire + bottom + upper + fan)
 ECO	 Large grill	 Fan assisted base

Other functions

 Defrost by time

Cleaning functions

 Vapor Clean

Hob options

Minute minder 1

Hob technical features

UR

Total no. of cook zones 5

Front left - Gas - Rapid - 2.90 kW

Rear left - Gas - Semi Rapid - 1.80 kW

Central - Gas - UR - 4.00 kW

Rear right - Gas - Semi Rapid - 1.80 kW

Front right - Gas - AUX - 1.00 kW

Type of gas burners Standard

Gas safety valves Yes

Automatic electronic ignition Yes

Burner caps Matte black enamelled

Main Oven Technical Features



No. of lights 1

Fan number 1

Net volume of the cavity 115 litres

Gross volume, 1st cavity 129 l

Cavity material Easy clean enamel

Shelf positions 5

Type of shelves Metal racks

Light type Halogen

Light power 40 W

Cooking time setting Timer + end of cooking

Door opening Flap down

Removable door Yes

Full glass inner door Yes

Removable inner door Yes

Total no. of door glasses 2

No. of thermo-reflective door glasses 1

Safety Thermostat Yes

Cooling system Tangential

Usable cavity space dimensions (HxWxD) 371x724x418 mm

Temperature control Electro-mechanical

Lower heating element power 1700 W

Upper heating element - Power 1200 W

Grill element 1700 W

Large grill - Power 2900 W

Circular heating element - Power 2000 W

Grill type Electric

Options Main Oven

End of cooking acoustic alarm Yes
 Minimum Temperature 50 °C

Maximum temperature 260 °C

Accessories included for Main Oven & Hob

Chrome shelf with back and side stop 1
 20mm deep tray 1

Electrical Connection

Max Power Draw 3200 W
 Current 14 A
 Voltage 220-240 V
 Type of electric cable Yes, Single phase

Power supply cable length 120 cm
 Frequency 50/60 Hz
 Terminal block 3 poles
 Plug No

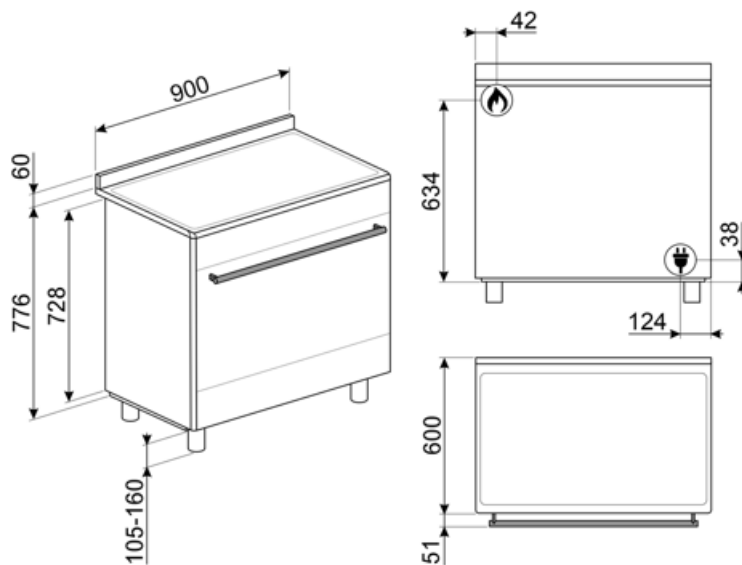

Compatible Accessories

AIRFRY9

Air fryer rack AIRFRY . Ideal for recreating traditional frying in the oven, but with fewer calories and less fat. It allows you to cook quickly and simply dishes such as French fries, fried vegetables and fish, ensuring perfect browning and crispiness.



BN920

Enamelled tray 90cm cavity, 20mm deep



GTP

Partially extractable telescopic guides (1 level) Extraction: 300 mm Material: Stainless steel AISI 430 polished



KITH95

Height extension kit (950 mm), stainless steel



PALPZ

Pizza shovel with fold away handle width: 315mm length : 325mm



SMOLD

Set of 7 silicone moulds for ice creams, ice lollies, pralines, ice cubes or to portion food. Usable from -60°C to +230°C

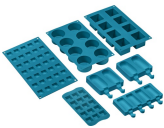

BBQ9

teflon-coated aluminum grid for 90 cm cavity



BN940

Enamelled tray 90 cm, 40 mm deep



GTT

Totally extractable telescopic guides (1 level) Extraction: 433 mm Material: Stainless steel AISI 430 polished



KITPDQ

Height reduction feet (850 mm), stainless steel, for cookers























SFLK1

Child lock



Symbols glossary

	A: Product drying performance, measured from A+++ to D / G depending on the product family		Installation in column: Installation in column
	Air cooling system: to ensure a safe surface temperatures.		Defrost by time: with this function the time of thawing of foods are determined automatically.
	Double glazed doors: Number of glazed doors.		Enamel interior: The enamel interior of all Smeg ovens have a special antacid lining which helps keep the interior clean by reducing the amount of cooking grease adhering to it.
	Fan assisted base: the mix of fan and lower heating element alone allows to finish cooking foods already cooked on the surface but not internally more quickly. This system is recommended to finish cooking foods that are already well cooked on the surface, but not internally, which therefore require a moderate higher heat. Ideal for any type of food.		Fan with upper and lower elements: The elements combined with the fan aim to provide more uniform heat, a similar method to conventional cooking, so pre-heat is required. Most suitable for items requiring slow cooking methods.
	Upper and lower element only: a traditional cooking method best suited for single items located in the centre of the oven. the top pf the oven will always be hottest. Ideal for roast, fruit cakes, bread etc.		ECO: The combination of the grill, fan and lower element is particularly suitable for cooking small quantities of food.
	Grill element: Using of grill gives excellent results when cooking meat of medium and small portions, especially when combined with a rotisserie (where possible). Also ideal for cooking sausages and bacon.		Circulaire with upper and lower elements: The use of the fan with both elements allows food to be cooked quickly and effectively, ideal for large joints that require thorough cooking. It offers a similar result to rotisserie, moving the heat around the food, instead of moving the food itself, enabling any size or shape to be cooked.
	All glass inner door: All glass inner door, a single flat surface which is simple to keep clean.		The inner door glass: can be removed with a few quick movements for cleaning.
	Side lights: Two opposing side lights increase visibility inside the oven.		Automatic opening: some models have Automatic opening door when the cycle is finished which is a perfect solution for handle-less kitchen units as no handle is needed. For safety reasons, the door locks automatically when the machine is in use to avoid it being opened inadvertently.
	The oven cavity has 5 different cooking levels.		Ultra rapid burners: Powerful ultra rapid burners offer up to 5kw of power.
	Vapor Clean: a simple cleaning function using steam to loosen deposits in the oven cavity.		The capacity indicates the amount of usable space in the oven cavity in litres.
	Knobs control		