

Double DishDrawer™ Dishwasher, Sanitise

Series 7 | Contemporary

Stainless Steel

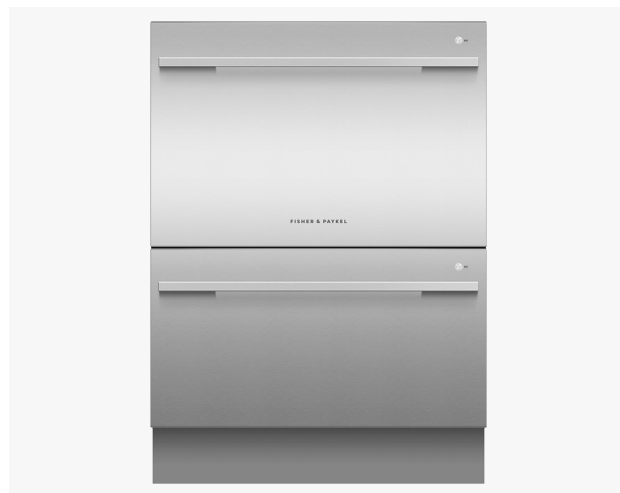

Wash one drawer while you load the other, with minimal bending. Or wash both at once, with room in each drawer for full size dinner plates.

- Six wash programs, as well as additional Quick wash, Sanitise and Extra Dry options
- Flexible racking can be folded down to fit bigger dishes

DIMENSIONS

Height	820 - 880 mm
Width	599 mm
Depth	573 mm

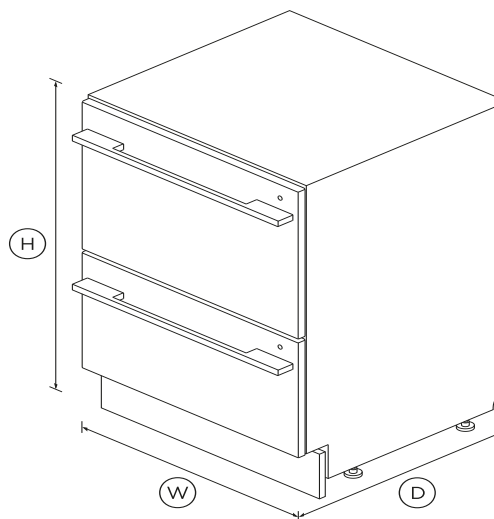

FEATURES & BENEFITS

Ease of use

DishDrawer™ Dishwashers are as easy to open and close as kitchen drawers, making loading dishes simple. Flexible racking allows you to make adjustments to fit in a variety of dishes.

Independent wash

With the ability to use both drawers independently and select different wash programs the DishDrawer™ Dishwasher can wash everything from fine glass and crystal to heavily soiled pots and pans.

SPECIFICATIONS

Accessories

Contemporary round handle kit	Part number 81645
Cutlery basket	2
Kickstrip	recessed
Knife clip and multipurpose	•

Capacity and Loading

Accommodates round plates	280mm
Adjustable height, foldable	•
Fold down tines	•
Pitch adjustable tines	•
Place settings	6

Consumption

Drying rating	A
Energy rating	A++
Energy usage	152kWh/year
Water usage	2184 litres per annum

Controls

Child lock	•
Electronic fault/Diagnostic	•
End of cycle beeps	•
Energy saving delay start	•
Internal wash selector	•
Rinse aid indicator light	•

Features

- Built-in water softener •
- Fan assisted drying •
- Flow through detergent •
- Quiet operation •
- SmartDrive™ technology •

Performance

Noise on standard cycle top **45dBA**

Power requirements

Amperage **8.5A**

Product dimensions

Depth **573 mm**
 Height **820 - 880 mm**
 Width **599 mm**

Warranty

Parts and labour **5 years**

Wash Programs

- Delicate •
- Eco •
- Extra Dry •
- Fast •
- Heavy •
- Medium •
- Number of wash programs **15**
- Quick •

- Rinse •
- Sanitise •
- Wash modifiers **3**





Water connection

Water pressure **0.1 Mpa - 1 Mpa**

SKU **81235**

The product dimensions and specifications in this page apply to the specific product and model. Under our policy of continuous improvement, these dimensions and specifications may change at any time. You should therefore check with Fisher & Paykel's Customer Care Centre to ensure this page correctly describes the model currently available. Â© Fisher & Paykel Appliances Ltd 2019.

Other product downloads available at fisherpaykel.com

-  [User Guide](#)
-  [Quick Start Guide](#)
-  [Service & Warranty Booklet](#)
-  [Installation Guide](#)
-  [Resources \(zip\)](#)



A PEACE OF MIND SALE
24 Hours 7 Days a Week Customer Support
 T 1300 650 590 W www.fisherpaykel.com