

# DF344BW



<b>Product Family</b>	Dishwashers
<b>Width</b>	60 cm
<b>Commercial height</b>	85 cm
<b>Installation</b>	Free-standing
<b>N° baskets</b>	3, FlexiDuo
<b>Motor</b>	Inverter 2.0
<b>EAN code</b>	8017709307813



## Programmes



<b>No. of programmes</b>	10+1	<b>Auto sensor 45-65</b>	Yes
<b>Washing temperatures</b>	38, 45, 50, 55, 65, 70, 75 °C	<b>Mix</b>	Yes
<b>Soak</b>	Yes	<b>Quiet (-2 dB)</b>	Yes
<b>Express 27'</b>	Yes	<b>Intense</b>	Yes
<b>Crystal</b>	Yes	<b>Self clean</b>	Yes
<b>Full express - 60 minutes</b>	Yes	<b>Hygiene 99,9%</b>	Yes
<b>ECO</b>	Yes		

## Options



<b>Dry Assist+ option</b>	Yes	<b>1/2 load FlexiZone option (varied distribution)</b>	Yes
<b>Delay timer option</b>	Up to 24 hours, with automatic soak	<b>Special programs option</b>	Yes

## Baskets



<b>Basket colour</b>	Grey	<b>Largest loadable dish in upper basket</b>	19,0 cm
<b>Basket components colour</b>	Grey	<b>Lower Basket</b>	With 4 foldable racks

<b>Handle</b>	In plastic on upper and lower basket	<b>Lower basket with anti-drip inserts</b>	Yes
<b>Upper Basket</b>	With 3 foldable racks	<b>Largest loadable dish in lower basket</b>	30,0 cm
<b>Glass holder</b>	Yes	<b>Colour Inner Components</b>	Blue
<b>Height adjustment of the upper basket</b>	On three levels	<b>Cutlery basket</b>	Yes
<b>Sliding Guides Extra Glide</b>	Yes		

## Technical Features



<b>Width (mm)</b>	598 mm	<b>Water softener</b>	With electronic setting
<b>Depth (mm)</b>	600 mm	<b>Turbidity sensor Aquatest</b>	Yes
<b>Display type</b>	3 digit	<b>Flood protection system</b>	Total Acquastop
<b>Product Height (mm)</b>	848 mm	<b>Water supply</b>	Single; cold/hot water max. 60°C - energysave with hot water up to 35%
<b>Controls</b>	Electronic	<b>Max water hardness</b>	100°FH;58°DH
<b>Display</b>	Delayed start, Programme time indicator, Time to end indication	<b>Drying system</b>	Natural condenser drying, with Dry Assist + automatic door opening system at the end of the cycle
<b>Programme graphics</b>	Symbols and printed key	<b>Steam protection</b>	In plastic
<b>On/off indicator</b>	Yes	<b>Tank material</b>	Stainless steel
<b>Salt light indicator</b>	Light	<b>Filter</b>	Stainless steel
<b>Rinse aid indicator</b>	Light	<b>Concealed heating element</b>	Yes
<b>Progress indicator</b>	Yes	<b>Hinges</b>	Self balancing with fixed hinges
<b>End of cycle indicator</b>	On display, with acoustic signal	<b>Adjustable feet</b>	Just for levelling
<b>Auto switch-off</b>	Yes	<b>Back cover</b>	Yes, with covered counterweight
<b>Washing system</b>	Planetarium	<b>Depth of dishwasher with open door (mm)</b>	1168 mm
<b>Third spray arm</b>	Single	<b>Removable top</b>	Yes, with optional KIT

## Performance / Energy Label

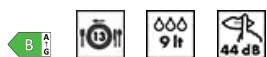

<b>Energy Efficiency Class (Washing cycle)</b>	B	<b>Programme duration</b>	4:25 h:min
<b>Energy consumption [per 100 cycles, based on the eco programme]</b>	63 kWh	<b>Airborne acoustical noise emissions (spinning phase)</b>	44 dB(A) re 1 pW
<b>Rated capacity (ps)</b>	13	<b>Airborne acoustical noise emission class</b>	B
<b>Water consumption [per cycle]</b>	9.0 litres	<b>Energy efficiency Index (EEI) (Washing cycle)</b>	37.9

## Electrical Connection

**Connected power** 1800 W  
**Current** 13 A  
**Voltage** 220-240 V  
**Frequency (Hz)** 50 Hz

**Type of connection** Single-phase  
**Power supply cable length** 140 cm  
**Plug** (G) UK e Singapore

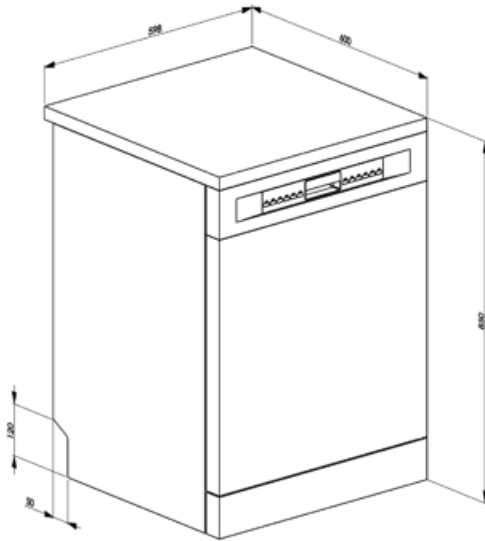

---

## Compatible Accessories

---

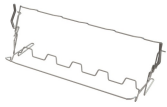

### KITGH

Kit glass holder. It has to be fitted on the first basket but only if there are foldable racks

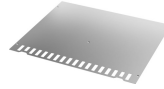

### KITINC

a steel bar fitted on the top will block the dishwasher at the top.



### KITPLV2

Kit extension for dishwasher and washing machine: length mt. 2

---

## Alternative products





















---



**DF344BX**

**Colour:** Stainless steel

## Symbols glossary

	Aquatest measures the clarity of the water during an auto program, and automatically ensures the minimum consumption of water and energy.		Anti-drip: Some models of dishwashers are equipped with special polymer nozzles anti-drip, that improve the process of drying.
	Energy efficiency class B		Delay Timer: The delay timer can postpone the start of the program by up to 24 hours.
	The Dry Assist + option, in addition to saving energy, ensures perfect drying of the dishes by opening the door automatically at the end of the wash cycle.		FlexiDuo: The FlexiDuo 3rd cutlery basket allows you to arrange cutlery or small cups, ladles, or bulky utensils however you like: it consists of two separate and moveable modules.
	FlexiZone: The 1/2 load flexizone allows you to wash a reduced load saving energy, water and time and there are no restrictions on where the items are placed.		The new ExtraGlide guide system, available on top of the range models, makes the second basket even smoother and softer. In fact, it facilitates the extraction of the introduction, even at full load and, for the greater excursion, the insertion of crockery is also facilitated in the rear part.
	The work aimed at continuous improvement has allowed the creation of the second generation of the Inverter motor 2.0, characterised by greater efficiency and durability over time, which allows very high performance and a lower energy consumption and noise level.		Noise Level: Excellent insulation and special devices keep noise to a minimum.
	PLANETARIUM_WASHING_SYSTEM_72dpi		Auto 45°- 65°: The auto programme regulates the length of a cycle depending on the need for a pre-wash and the number of rinses required.
	Crystals: The Crystals programme is dedicated to delicate dishes such as glasses and china.		Eco: Eco, this economic wash programme uses a low amount of water and energy in order to provide the most environmentally friendly cleaning option.
	Quick wash cycle for normally soiled mixed loads such as dishes and pans, even with dried-on residues. Dishes are washed and dried in 60 minutes.		Normal programme: The normal programme is suitable for normal degrees of dirt for everyday use.
	Soak programme: The soak programme provides a rinse to prevent dirt from drying.		Rapid 27 Mins: The rapid 27 mins quick program takes just 27 minutes to wash a load.
	Ultraclean: The Ultraclean option performs a final rinse at a high temperature of 70°C eliminating virtually all bacteria.		The symbols show the number of plate settings of the dishwasher.
	Total Acquastop: In addition to the partial Acquastop protection present in all Smeg dishwashers, some models have an electronic device fitted to the water intake hose, which monitors water levels in the machine, detects leaks in the hose and switches off the water supply immediately when necessary.		System WaterSave ensures the best washing results with minimal water consumption depending on the model of dishwasher.



Dishwasher cleaning cycle. The cycle should be started with the machine empty, without dishes. It is recommended to run the program every 2-3 months, using special dishwasher detergents.



Allows you to enable additional programs when selected together with any wash cycle.



**SILENT:** Wash cycle suitable for normally soiled dishes, even with dried-on residues. Ensures maximum noise reduction and is therefore ideal if you wish to run it during the night.



**HYGIENE 99.9%** High-temperature washing programme. The 75° rinse guarantees the removal of 99.9% of germs and bacteria, making it ideal for sanitising