

Operating and installation instructions Combination steam oven



To avoid the risk of accidents or damage to the appliance it is **essen-
tial** to read these instructions before it is installed and used for the
first time.

Contents

Warning and Safety instructions	8
Caring for the environment	17
Guide to the appliance	18
Combination steam oven	18
Data plate	20
Accessories supplied	20
Controls	23
On/Off sensor control	24
Proximity sensor	24
Sensor controls	25
Touch display	26
Symbols	27
Using the appliance	28
Selecting a menu option	28
Scrolling	28
Exiting a menu	28
Changing a value or setting	28
Changing a setting in a list	28
Entering numbers with the roller	28
Entering numbers using the numerical keypad	28
Changing the setting with a segment bar	29
Entering letters	29
Displaying the context menu	29
Moving entries	29
Displaying the pull-down menu	30
Displaying Help	30
Activating MobileStart	30
Description of functions	31
Control panel	31
Water container	31
Condensate container	31
Food probe	31
Temperature/core temperature	31
Moisture	32
Cooking duration	32
Noises	32
Heating-up phase	33
Cooking phase	33
Steam reduction	33

Oven interior lighting	33
Before using for the first time	34
Miele@home	34
Basic settings	35
Cleaning the combination steam oven for the first time	36
Setting the correct boiling point for water	37
Pre-heating the combination steam oven	38
Settings	39
Settings overview	39
Opening the “Settings” menu.....	42
Language 	42
Time.....	42
Date	43
Lighting.....	43
Start screen	44
Display.....	44
Volume.....	45
Units	45
Keeping warm	46
Steam reduction	46
Recommended temps.....	46
Booster	47
Automatic rinsing	47
Water hardness	48
Movement sensor	49
Safety	50
Furniture front recognition	51
Miele@home	51
Remote control.....	52
Activating MobileStart	52
SuperVision	53
Remote Update	54
Software version.....	55
Legal information.....	55
Showroom programme.....	55
Factory default.....	55
Alarm + minute minder	56
Using the Alarm function.....	56
Using the Minute minder function	56
Main and sub-menus	58

Contents

Energy saving tips	60
Operation	62
Changing values and settings for a cooking programme.....	63
Changing the temperature and core temperature	64
Changing the Moisture	64
Setting cooking durations	64
Changing the set cooking durations	65
Deleting the set cooking durations.....	65
Cancelling a cooking programme	66
Interrupting a cooking process.....	66
Pre-heating the oven compartment	67
Booster.....	67
Pre-heat.....	68
Crisp function	68
Releasing bursts of steam.....	69
Changing the function	70
General notes	71
The advantages of cooking with steam	71
Suitable containers.....	71
Shelf level	72
Frozen food.....	72
Temperature	72
Cooking duration	72
Cooking with liquid.....	72
Your own recipes – steam cooking	72
Universal tray and combi rack.....	73
Steam cooking	74
Eco Steam cooking	74
Notes on the cooking tables	74
Vegetables.....	75
Fish.....	78
Meat	81
Rice	83
Grain	84
Pasta	85
Dumplings	86
Dried pulses	87
Hen's eggs	89
Fruit	90
Sausages.....	90
Shellfish.....	91

Mussels	92
Menu cooking (cooking whole meals) - manually	93
Sous-vide (vacuum) cooking	95
Special applications	103
Reheat	103
Defrost	105
Mix & Match	108
Menu cooking – automatic	116
Bottling	117
Bottling cakes	120
Drying	121
Sabbath programme	122
Extracting juice with steam	123
Blanching.....	124
Disinfect items	124
Heat crockery	125
Keeping warm	125
Prove dough	126
Heating damp flannels	126
Dissolve gelatine	126
Decrystallise honey	127
Melt chocolate.....	127
Cook bacon.....	128
Sweat onions.....	128
Apple storage	129
Making eierstich	129
Fruit preserve.....	130
Skinning vegetables and fruit.....	131
Make yoghurt	132
Automatic programmes	133
Categories	133
Using automatic programmes	133
Usage notes	133
Search	134
MyMiele	135
User programmes	136
Baking	140
Baking tips.....	140

Contents

Tips on baking	141
Notes on the functions	141
Roasting	143
Tips for roasting	143
Notes on the functions	143
Food probe	145
Grilling	148
Grilling tips	148
Tips for grilling	148
Notes on the functions	149
Cleaning and care	150
Important information on cleaning and care	150
Unsuitable cleaning agents	151
Cleaning the front	151
PerfectClean	152
Oven compartment	153
Cleaning the water container and condensate container	154
Accessories	155
Cleaning the side runners	156
Lowering the top heat/grill element	157
Maintenance	158
Soak	158
Drying	158
Rinsing	158
Descaling	158
HydroClean	160
Removing the door	165
Fitting the door	166
Problem solving guide	167
Messages on the display	167
Unexpected behaviour	169
Noises	171
Unsatisfactory results	171
General problems or technical faults	172
Optional accessories	175
Containers	175
Other	175
Cleaning and care products	175

Contents

Service	176
Contact in the event of a fault	176
Warranty	176
Installation	177
Safety instructions for installation	177
Building-in dimensions	178
Installation in a tall unit.....	178
Installation in a base unit.....	179
Side view	180
Swivel range for control panel.....	181
Connection and ventilation.....	182
Installing the combination steam oven.....	183
Electrical connection	184
Note for test institutes	185
Energy efficiency class according to EN 60350-1.....	187
UK Conformity declaration	189
EU Conformity declaration	190
Copyrights and licences	191

Warning and Safety instructions

This combination steam oven complies with all current local and national safety requirements. Inappropriate use can, however, lead to personal injury and material damage.

Read the operating and installation instructions carefully before using the combination steam oven. They contain important information on safety, installation, use and maintenance. This prevents both personal injury and damage to the combination steam oven.

In accordance with standard IEC/EN 60335-1, Miele expressly and strongly advises that you read and follow the instructions in the chapter on installing the combination steam oven as well as the safety instructions and warnings.

Miele cannot be held liable for injury or damage caused by non-compliance with these instructions.

Keep these instructions in a safe place and pass them on to any future owner.

Correct application

- ▶ This combination steam oven is intended for domestic use and use in other similar environments.
- ▶ This combination steam oven is not intended for outdoor use.
- ▶ The combination steam oven is intended for domestic use only to steam-cook, bake, roast, grill, defrost and reheat food. All other types of use are not permitted.
- ▶ This combination steam oven may only be used by people with reduced physical, sensory or mental capabilities or lack of experience and knowledge if they are supervised whilst using it. They may only use it unsupervised if they have been shown how to use it in a safe manner. They must be able to recognise and understand the dangers of misuse.
- ▶ The oven compartment is equipped with special lamps to cope with particular conditions (e.g. temperature, moisture, chemical resistance, abrasion resistance and vibration). These special lamps must only be used for the purpose for which they are intended. They are not suitable for room lighting. Replacement lamps may only be fitted by a Miele authorised technician or by the Miele Customer Service Department.
- ▶ The combination steam oven contains 3 light sources corresponding to energy efficiency class E.

Warning and Safety instructions

Safety with children

- ▶ Activate the system lock to ensure that children cannot switch the combination steam oven on by mistake.
- ▶ Children under 8 years of age must be kept away from the combination steam oven unless they are constantly supervised.
- ▶ Children aged 8 and older may only use the combination steam oven without supervision if they have been shown how to use it in a safe manner. Children must be able to understand and recognise the possible dangers caused by incorrect operation.
- ▶ Children must not be allowed to clean or maintain the combination steam oven unsupervised.
- ▶ Children should be supervised in the vicinity of the combination steam oven. Never allow children to play with the combination steam oven.
- ▶ Risk of suffocation due to packaging material. Whilst playing, children may become entangled in packaging material (such as plastic wrapping) or pull it over their head, presenting the risk of suffocation. Keep packaging material away from children.
- ▶ Risk of injury caused by hot surfaces and steam. Children's skin is far more sensitive to high temperatures than that of adults. External parts of the combination steam oven such as the door glass, control panel and the vent become quite hot. Do not let children touch the combination steam oven when it is in operation. Keep children well away from the combination steam oven until it has cooled down and there is no risk of injury.
- ▶ Risk of injury from the open door. The oven door can support a maximum weight of 10 kg. Children could injure themselves on an open door. Do not let children sit on the open door, lean against it or swing on it.

Technical safety

- ▶ Unauthorised installation, maintenance and repairs can cause considerable danger for the user. Installation, maintenance and repairs must only be carried out by a Miele authorised technician.
- ▶ Damage to the combination steam oven can compromise your safety. Check the combination steam oven for visible signs of damage. Do not use a damaged combination steam oven.
- ▶ Temporary or permanent operation on an autonomous power supply system or a power supply system that is not synchronised with the mains power supply (e.g. island networks, back-up systems) is possible. A prerequisite for operation is that the power supply system complies with the specifications of EN 50160 or an equivalent standard.

The function and operation of the protective measures provided in the domestic electrical installation and in this Miele product must also be maintained in isolated operation or in operation that is not synchronised with the mains power supply, or these measures must be replaced by equivalent measures in the installation. As described, for example, in the current version of BS OHSAS 18001–2 ISO 45001.

- ▶ The electrical safety of this combination steam oven can only be guaranteed when correctly earthed. It is essential that this basic safety requirement is fulfilled. If in doubt, the electrical installation should be checked by a qualified electrician.
- ▶ The connection data (voltage and frequency) on the data plate of the combination steam oven must match the mains electricity supply in order to avoid the risk of damage to the oven. Compare this before connecting the appliance to the mains. If in any doubt, consult a qualified electrician.
- ▶ Multi-socket adapters and extension leads do not guarantee the required safety of the appliance. Do not use these to connect the combination steam oven to the domestic electrical supply.

Warning and Safety instructions

- ▶ For safety reasons, the combination steam oven may only be used when it has been fully installed.
- ▶ This combination steam oven must not be used in a non-stationary location (e.g. on a ship).
- ▶ Risk of injury due to electric shock. Any contact with live connections or tampering with the electrical or mechanical components of the combination steam oven will endanger your safety and may lead to appliance malfunctions.
Do not open the housing of the combination steam oven under any circumstances.
- ▶ While the combination steam oven is under warranty, repairs should only be undertaken by a service technician authorised by the Miele Customer Service Department. Otherwise the warranty will be invalidated.
- ▶ Miele can only guarantee the safety of the appliance when genuine original Miele replacement parts are used. Faulty components must only be replaced by Miele spare parts.
- ▶ If the plug is removed from the mains connection cable or if the mains connection cable is supplied without a plug, the combination steam oven must be connected to the electrical supply by a qualified electrician.
- ▶ If the mains connection cable is damaged, it must be replaced with a special mains connection cable (see “Electrical connection” in the “Installation” chapter).
- ▶ During installation, maintenance and repair work, the combination steam oven must be completely disconnected from the mains electricity supply. To ensure this, do one of the following:
 - Disconnect the mains fuse
 - Completely unscrew the screw-out fuse (in countries where this is applicable)

Warning and Safety instructions

- Pull out the plug (if one is present) at the wall socket. To do this, pull the plug and not the mains connection cable.
- ▶ If the combination steam oven is built in behind a furniture front (e.g. a door), do not close the furniture door while the oven is in use. Heat and moisture can build up behind the furniture front when closed. This can result in damage to the combination steam oven, the housing unit and the floor. Leave the furniture door open until the combination steam oven has cooled down completely.
- ▶ In areas which may be subject to infestation by cockroaches or other vermin, pay particular attention to keeping the appliance and its surroundings clean at all times. Any damage caused by cockroaches or other vermin will not be covered by the warranty.

Correct use

- ▶ Risk of injury caused by hot surfaces and steam. The combination steam oven gets hot during operation. You could burn yourself on the steam, heater elements, oven compartment, accessories or food. Use oven gloves when placing hot food in the appliance or removing it and when working in the hot oven compartment.
- ▶ Risk of injury caused by hot food.
Food may spill or splash around when placing it into the oven or removing it. The food can cause burns.
When placing cooking containers into the oven or removing them, make sure that the hot food does not spill.
- ▶ Heating up food in closed containers, such as tins or sealed jars, will result in an increase in pressure, which can cause them to explode. Do not heat up unopened tins or jars of food in the oven.

Warning and Safety instructions

▶ Plastic dishes that are not suitable for use in an oven will melt and may ignite at high temperatures, and can damage the combination steam oven.

Use only plastic containers that are suitable for use in an oven. Follow the instructions from the crockery manufacturer.

If you wish to use plastic containers for steam cooking, make sure that these are heat-resistant to 100 °C and able to withstand hot steam. Other plastic containers can melt or become fragile and brittle.

▶ Food which is left in the oven compartment can dry out and the moisture released can lead to corrosion damage in the combination steam oven. Do not leave food in the oven compartment and do not use any cooking containers which are susceptible to corrosion.

▶ Risk of injury from the open door. You could bang into the open door or trip over it. Avoid leaving the door open unnecessarily.



▶ The door can support a maximum load of 10 kg. Do not lean or sit on the door when open, or place heavy items on it. Make sure that nothing gets trapped between the door and the oven compartment. This could damage the combination steam oven.

▶ Oils and fats can ignite if allowed to overheat. Never leave the combination steam oven unattended when cooking with oil or fats. Never attempt to put out oil or fat fires with water. Switch the combination steam oven off and extinguish the flames by leaving the door closed.

▶ Due to the high temperatures radiated, objects left near the combination steam oven could catch fire. Do not use the combination steam oven to heat up the room.

▶ Grilling food for excessively long cooking durations can cause it to dry out with the risk of catching fire. Do not exceed the recommended cooking durations.

Warning and Safety instructions

- ▶ Some types of food dry out quickly and can self-ignite if high grill temperatures are used.
Never use the grill to finish baking part-cooked rolls or bread or to dry flowers or herbs. Use Fan plus  or Conventional heat  for this type of procedure.
- ▶ To avoid fuelling any flames, do not open the combination steam oven door if there is smoke inside the oven compartment. Interrupt operation by switching the combination steam oven off and disconnecting it from the electricity supply. Do not open the door until the smoke has dispersed.
- ▶ If using alcohol in your recipes, please be aware that high temperatures can cause the alcohol to vaporise. The vapour can catch fire on hot heating elements.
- ▶ Never line the floor of the oven compartment with aluminium foil or oven liners. Do not place any crockery or any pans, pots or baking trays directly on the floor of the oven compartment.
If you want to use the floor of the oven compartment as an extra surface, place the rack on the floor of the oven compartment with the rack surface facing up and the cooking container on top. In doing so, ensure that the filter in the floor of the oven is not moved.
- ▶ The oven compartment floor can become damaged by the rack being pushed around on it.
Do not push the rack around on the oven compartment floor.
- ▶ Larger deposits of food can block the drain and pump. Always make sure that the filter in the floor of the oven is inserted.
- ▶ When using a electrical appliance, e.g. a hand-held blender, near the combination steam oven, ensure that the mains connection cable of the appliance cannot get trapped in the combination steam oven door. This could damage the insulation on the cable.
- ▶ The steam could reach live electrical components and cause a short circuit. This could also destroy the electrical components. Do not use the combination steam oven if it does not have a lamp cover.

Warning and Safety instructions

Cleaning and care

- ▶ Risk of injury due to electric shock. The steam from a steam cleaning appliance could reach live electrical components and cause a short circuit. Do not use a steam cleaner to clean the appliance.
- ▶ Scratches on the door glass can result in the glass breaking. Do not use abrasive cleaners, hard sponges, brushes or sharp metal tools to clean the door glass.
- ▶ The side runners can be removed (see “Cleaning and care – Cleaning the side runners”). Refit the side runners correctly.
- ▶ Try to avoid the interior walls being splashed with food or liquids containing salt. If it does happen, wipe these away thoroughly to avoid corrosion to stainless steel surfaces inside the cabinet.

Accessories

- ▶ Only use genuine original Miele accessories and spare parts with this appliance. Using accessories or spare parts from other manufacturers will invalidate the warranty and Miele cannot accept liability.
- ▶ Miele will guarantee to supply functional spare parts for a minimum of 10 years and up to 15 years following the discontinuation of your combination steam oven.
- ▶ Only use the Miele food probe supplied with this oven. If it is faulty, it must only be replaced with a suitable original Miele food probe.
- ▶ The plastic on the food probe can melt at very high temperatures. Do not use the food probe when using the grill functions (exception: Fan Grill ). Do not store the food probe in the oven if it is not in use.

Disposing of the packaging material

The packaging material is used for handling and protects the appliance from transport damage. The packaging material used is selected from materials which are environmentally friendly for disposal and can generally be recycled.

Recycling the packaging material reduces the use of raw materials. Use material-specific collection points for valuable materials and take advantage of return options. Your Miele dealer will take the packaging material away.

Disposing of your old appliance

Electrical and electronic appliances contain many valuable materials. They also contain certain materials, compounds and components which were essential for their correct functioning and safety. These could be hazardous to human health and to the environment if disposed of with household waste or if handled incorrectly. Please do not, therefore, dispose of your old appliance with household waste.



Instead, please make use of officially designated collection and disposal points to dispose of and recycle electrical and electronic appliances in your local community, with your dealer or with Miele, free of charge. By law, you are solely responsible for deleting any personal data from the old appliance prior to disposal. You are legally obliged to remove any old batteries which are not securely enclosed by the appliance and to remove any lamps without destroying them, where this is possible. These must be taken to a suitable collection point where they can be handed in free of charge. Please ensure that your old appliance poses no risk to children while being stored for disposal.

Guide to the appliance

Combination steam oven

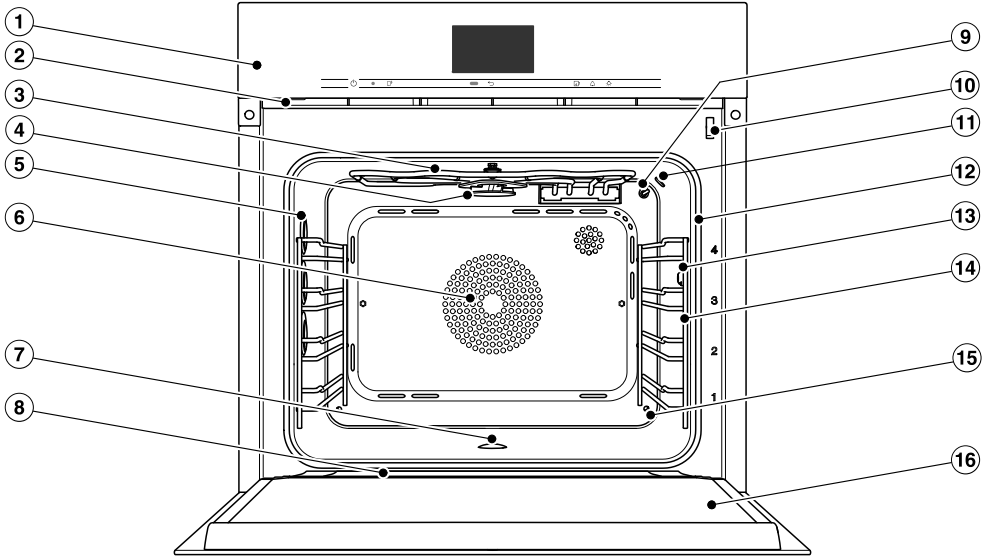

- ① Control elements
- ② Ventilation outlet
- ③ Top heat/grill element
- ④ Distribution wheel for HydroClean cleaning
- ⑤ Oven interior lighting
- ⑥ Air inlet for the fan with ring heating element behind it
- ⑦ Oven compartment floor with bottom heater element and floor filter underneath it
- ⑧ Drip channel
- ⑨ Temperature sensor
- ⑩ Door lock for HydroClean cleaning
- ⑪ Moisture sensor
- ⑫ Door seal
- ⑬ Connection socket for the food probe
- ⑭ Side runners with 4 shelf levels
- ⑮ Steam inlet
- ⑯ Door

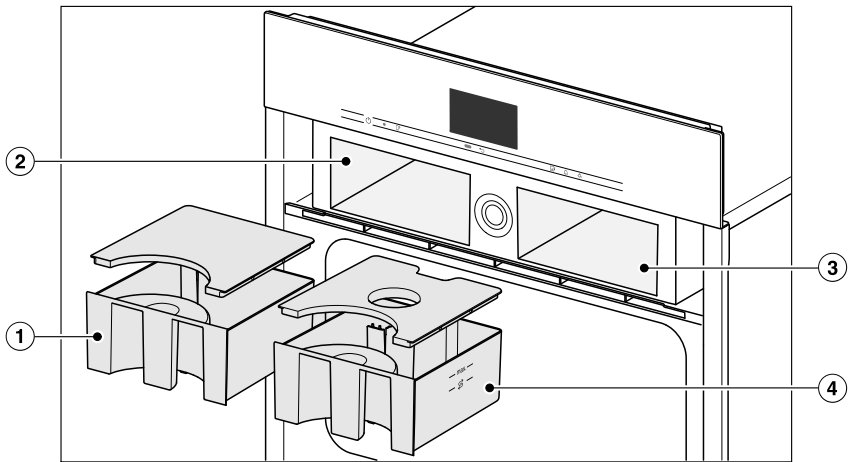

- ① Condensate container
- ② Condensate container compartment
- ③ Compartment for water container
- ④ Water container

Guide to the appliance

A list of the models described in these operating and installation instructions can be found on the back page.

Data plate

The data plate is located on the top of the housing.

The data plate states the model identifier, the serial number as well as connection data (mains voltage, frequency and maximum rated load).

The model identifier and the serial number (SN) can also be found on the small plate at the top on the opened control panel.

Please have this information to hand, should you need to contact Miele regarding any questions or problems.

Accessories supplied

The accessories supplied with your appliance as well as a range of optional ones are available to order from Miele (see "Optional accessories").

DGG 20

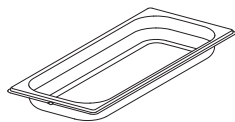

1 solid cooking container
Gross capacity 2.4 l / Usable capacity 1.8 l
450 x 190 x 40 mm (W x D x H)

DGGL 20

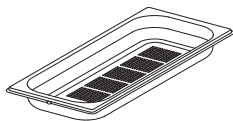

1 perforated cooking container
Gross capacity 2.4 litres / Usable capacity 1.8 litres
450 x 190 x 40 mm (W x D x H)

Universal tray

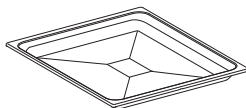

1 universal tray for baking, roasting and grilling

Combi rack



1 combi rack for baking, roasting and grilling

Food probe

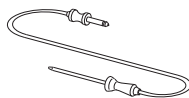

Food probe for precise temperature controlled cooking. The food probe monitors the inner temperature of the meat (core temperature).

HydroCleaner

1 special cleaning agent for cleaning the oven compartment with the HydroClean care programme. Particularly suitable for removing heavy, stubborn soiling.

Descaling tablets

For descaling the combination steam oven

FlexiClip runners HFC 71

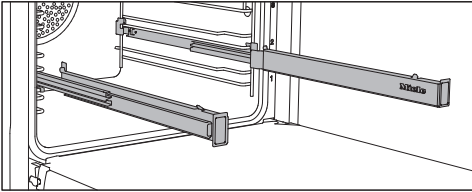

The FlexiClip runners can be attached to any shelf level.

Push the FlexiClip runners fully into the oven compartment before placing accessories on them.

The accessories will then automatically sit securely in between the stoppers at either end of each runner and be prevented from sliding off.

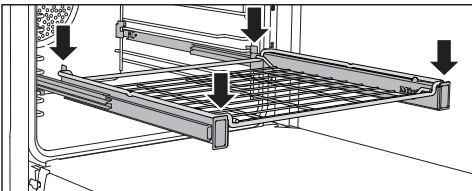
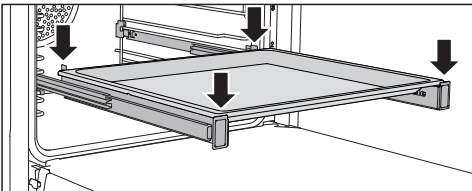

The FlexiClip runners can support a maximum load of 15 kg.

Fitting and removing FlexiClip runners

 Risk of injury caused by hot surfaces.

The combination steam oven gets hot during operation. You could burn yourself on the heater elements, oven compartment or accessories.

Allow the heater elements, oven compartment and the accessories to cool before fitting or removing the FlexiClip runners.

The FlexiClip runners are fitted in between the two rails that make up a shelf level.

The FlexiClip runner with the Miele logo should be fitted on the right.

When fitting or removing the FlexiClip runners, **do not** extend them.

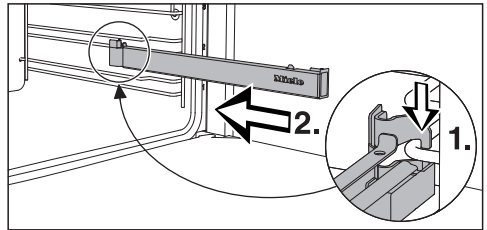

- Hook the FlexiClip runner onto the front of the lower rail of a shelf level (1.) and then push it along the rail into the oven compartment (2.).

Guide to the appliance

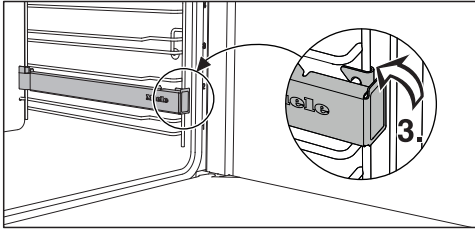

- Then secure the FlexiClip runner to the lower rail of the shelf level (3.).

If the FlexiClip runners are difficult to pull out after fitting, pull firmly on them once to release them.





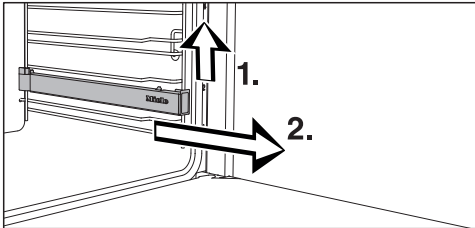

To remove a FlexiClip runner, proceed as follows:

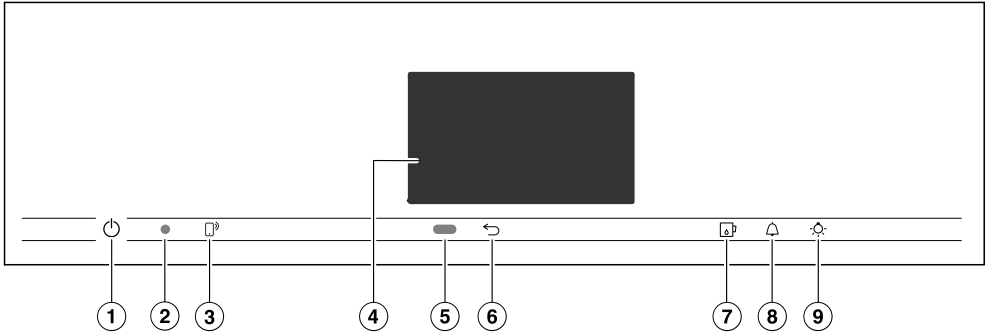
- Push the FlexiClip runner in all the way.



- Remove the FlexiClip runner by raising it at the front (1.) and then pulling it forwards along the rail of the shelf level and out (2.).



- ① Recessed  On/Off sensor control
For switching the combination steam oven on and off
- ② Optical interface
(For Miele Service only)
- ③  sensor control
For controlling the combination steam oven via your mobile device
- ④ Touch display
For displaying information and for operation
- ⑤ Movement sensor
For switching on the oven interior lighting and the display, and to acknowledge the buzzer when movement is detected
- ⑥  sensor control
To go back a step
- ⑦ Sensor control 
For opening and closing the control panel
- ⑧  sensor control
For setting the minute minder or alarms
- ⑨  sensor control
For switching the oven interior lighting on and off

Controls

On/Off sensor control

The  On/Off sensor control is recessed and responds to touch.

Use this sensor control to switch the combination steam oven on and off.

Proximity sensor





The proximity sensor is located under the touch display next to the  sensor control. The proximity sensor detects when you approach the touch display, e.g. with your hand or body.

If you have activated the corresponding settings, you can switch on the oven interior lighting, switch on the combination steam oven or acknowledge buzzers (see “Settings” – “Movement sensor”).

Sensor controls

The sensor controls react to touch. Every touch of a sensor control is confirmed with an audible tone. This audible tone can be switched off by selecting the **Volume | Keypad tone | Off** setting.

If you want the sensor controls to respond even when the combination steam oven is switched off, select the **Display | QuickTouch | On** setting.

Sensor control	Function
	<p>If you want to control the combination steam oven from your mobile device, you must have the Miele@home system, switch on the Remote control setting and touch this sensor control. The sensor control then lights up orange and the MobileStart function is available.</p> <p>As long as this sensor control is lit, you can control the combination steam oven via your mobile device (see “Settings” – “Miele@home”).</p>
	<p>Depending on which menu you are in, this will take you back a level or back to the main menu.</p>
	<p>Use this sensor control to open and close the control panel (see “Control panel” in the “Functional description” chapter).</p>
	<p>If a menu appears in the display or if a cooking programme is in progress, you can use this sensor control to set a minute minder (e.g. when boiling eggs) or an alarm (a specific time) at any point (see “Alarm and minute minder”).</p>
	<p>Select this sensor control to switch the oven interior lighting on and off.</p> <p>Depending on the setting selected, the oven interior lighting switches off after 15 seconds or remains constantly switched on or off.</p>

Controls

Touch display

The sensitive surface of the touch display can be scratched by pointed or sharp objects, e.g. pens.

Only touch the display with your fingers.

Make sure that water cannot get behind the touch display.

The touch display is split into multiple areas.

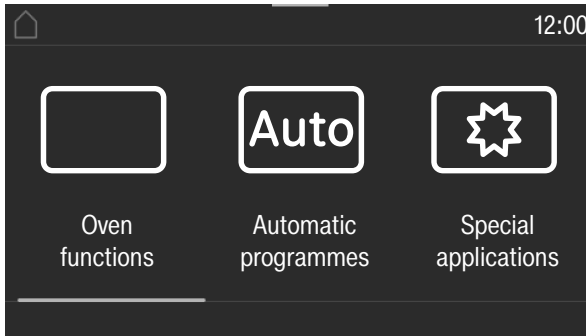

The menu path appears on the left of the **header**. The individual menu options are separated by a vertical line. ... I indicates that there are more options available, which are not visible because there is not enough space in the display.

If you touch a menu name in the header, the display will switch to that menu. To switch to the status display, touch .

The time of day is shown on the right of the header. You can set the time of day by touching the display.

Additional symbols may also appear, e.g. SuperVision .

At the top of the header there is an orange line where you can drag down the pull-down menu. This allows you to switch settings on or off during a cooking programme.

The current menu and menu options are shown in the **centre**. You can scroll to the right or left by swiping your finger across the display to the right or left. Touch a menu option to select it (see “Operation”).

The operation fields that appear in the **footer** vary according to the menu that is selected; for example: Timer, Save or OK.

Symbols

The following symbols may appear in the display:

Symbol	Meaning
	This symbol indicates that there is additional information and advice about using the appliance. Press the <i>OK</i> sensor control to confirm the information.
	This indicates that there are more options available, which are not visible because there is not enough space in the display.
	Water level indicator
	Alarm
	Minute minder
	Some settings, e.g. display brightness and buzzer volume are selected using a bar chart.
	The system lock or sensor lock is on (see “Settings – Safety”). The controls are locked.
	Core temperature when using the food probe
	Remote control (only appears if you are in the Miele@home system and have selected the <i>Remote control On</i> setting)
	SuperVision (only appears if you are in the Miele@home system and have selected the <i>SuperVision SuperVision display On</i> setting)

Using the appliance

You operate the combination steam oven via the touch display by touching the desired menu option.

Each time you touch a possible option, the relevant characters (word and/or symbol) light up **orange**.

Fields for confirming an operating step are highlighted in **green** (e.g. *OK*).

Selecting a menu option

- Touch the field or value you want in the display.

Scrolling

You can scroll left or right.

- Swipe across the screen. To do this, place your finger on the touch display and swipe it in the direction you want.

The bar at the bottom shows you where you are in the current menu.

Exiting a menu

- Touch the ↩ sensor control or touch the ... I symbol in the menu path.
- Touch the ⏪ symbol to switch to the status display.

Entries made before this which have not been confirmed with *OK* will not be saved.

Changing a value or setting

Changing a setting in a list

The current setting is highlighted in orange.

- Touch the desired setting.

The setting is now saved. This will take you back to the previous menu.

Entering numbers with the roller

- Swipe the roller up or down until the value you want is displayed in the centre.

- Confirm with *OK*.

The changed number is now saved.

Entering numbers using the numerical keypad

- Tap on the value that is in the middle of the numerical keypad.

The numerical keypad will appear.

- Touch the desired numbers.

As soon as you enter a valid value, *OK* turns green.

Use the arrow to delete the last entered number.

- Confirm with *OK*.

The changed number is now saved.

Changing the setting with a segment bar

Some settings are represented by a bar ■■■■■■■ with seven segments. If all of the segments are illuminated, the maximum value is selected.

If none of the segments are illuminated or if only one is, the minimum value is selected or the setting is switched off altogether (e.g. buzzers).

- Touch the corresponding segment on the segment bar to change the setting.
- Select **On** or **Off** to switch the setting on or off.
- Confirm your selection with **OK**.

The setting is now saved. This will take you back to the previous menu.

Entering letters

Letters are entered using a display keyboard. It is best to select short names.

- Touch the desired letters or characters.

Tip: You can add a line break for longer programme names using the **↵** symbol.

- Touch **Save**.

The name is now saved.

Displaying the context menu

In some menus you can display a context menu, e.g. to rename User programmes or to move entries under **MyMiele**.

- For example, touch a User programme and keep your finger on it until the context menu opens.
- To close the context menu, touch an area of the display located outside of the menu window.

Moving entries

You can change the order of User programmes or entries under **MyMiele**.

- For example, touch a User programme and keep your finger on it until the context menu opens.
- Select **Move**.
- Keep your finger on the highlighted field and drag it to the desired location.

Using the appliance

Displaying the pull-down menu

During a cooking programme, you can switch settings such as **Booster** or **Pre-heat** and the **WiFi** function on or off.

- Use the orange line under the header to drag the pull-down menu down.
- Select the setting you want to change.
Active settings are highlighted in orange. Depending on the selected colour scheme, inactive settings are highlighted either in black or white (see “Settings – Display”).
- To close the pull-down menu, drag it back up to the top or touch an area of the display located outside of the menu window.

Displaying Help

Context-sensitive help is available for certain functions. In this case, **Help** appears in the bottom line.

- Touch **Help** to display information in text and pictures.
- Touch **Close** to return to the previous menu.

Activating MobileStart

- Select the  sensor control to activate MobileStart.

The  sensor control lights up. You can operate your combination steam oven remotely with the Miele app.

Directly operating the combination steam oven takes priority over operating it via the remote control function on the app.

You can use MobileStart as long as the  sensor control is lit up.

Control panel

The water container and the condensate container are located behind the control panel. The control panel is opened and closed by pressing the  sensor control. It is fitted with anti-trapping protection. If the control panel senses resistance when opening/closing, the process is cancelled. Do not touch the upper edge of the door when the control panel is opening and closing.

Water container

The maximum filling volume is 1.4 l and the minimum is 1.0 l. There are markings on the water container. The upper marking must never be exceeded.

Water consumption depends on the type of food and the cooking duration. The water may need to be topped up during cooking. Water consumption is increased if the door is opened during cooking.

Fill the water container to the maximum level before each cooking programme involving steam.

Condensate container

Condensate that collects in the appliance from cooking is pumped into the condensate container. The container has a maximum capacity of 1.4 litres.

Food probe

The food probe measures the core temperature in the food, enabling the temperature during the cooking process to be monitored simply and accurately.

Temperature/core temperature

Some functions have a pre-set recommended temperature. The recommended temperature can be altered within the given range for an individual cooking programme, a programme stage or for every time that programme is used (see “Recommended temperatures” in the “Settings” chapter).

The core temperature can also be altered within the given range for an individual programme or a specific programme stage.

Description of functions

Moisture

The Combi mode  function and Re-heat special application use a combination of oven heat and moisture. The moisture level can also be selected within the given range for an individual programme or a specific programme stage.

Depending on the moisture setting, moisture or fresh air is supplied to the oven compartment. When the moisture setting = 0 %, the maximum fresh air supply is implemented and no moisture is supplied. When the moisture setting = 100 %, there is no fresh air supply and the moisture content is at its maximum.

Some food gives off moisture during the cooking process. This moisture from the food also controls the amount of moisture needed. If the required amount of moisture is low, the steam generator may not be activated at all.

Cooking duration

Depending on the function, you can set a cooking duration of between 1 minute and 6, 10 or 12 hours.

The cooking durations of the Automatic, Maintenance and Menu cooking programmes are set at the factory and cannot be altered.



When cooking with steam, as well as for programmes and applications with pure steam operation, the cooking duration does not begin until the set temperature is reached. It starts immediately for all other functions, programmes and applications.

Noises

A humming sound can be heard during operation and after switching off the combination steam oven. This noise does not indicate incorrect operation or an appliance fault. The noise is made by water being pumped through the system.

When the combination steam oven is in use, you will hear a fan noise.

Heating-up phase

In all functions, the display shows the temperature in the oven compartment as it rises during the heating-up phase (exceptions: Full grill , Economy grill ).

When cooking with steam, the duration of the heating-up phase will depend on the quantity and the temperature of the food. In general, the heating-up phase will last for approx. 7 minutes. The duration will be longer if you are cooking refrigerated or frozen food. The heating-up phase may also last longer if cooking temperatures are low or if you are using the Sous-vide  cooking function.

Cooking phase

The elapsing remaining time is shown in the display during the cooking phase. When cooking with steam, the cooking phase begins once the set temperature is reached. It starts immediately for all other functions, programmes and applications.

Steam reduction

With steam cooking and combination cooking, the steam reduction function will switch on automatically at the end of a cooking programme which uses a temperature within a certain temperature range. The function stops excessive steam escaping when the door is opened. Steam reduction will appear in the display.

Steam reduction can be switched off (see “Steam reduction” in the “Settings” chapter). With steam reduction switched off, a lot of steam will escape when the door is opened.

Oven interior lighting

For energy-saving reasons, the combination steam oven interior lighting has been set at the factory to go out once a programme has begun.

If you want it to stay on all the time the oven is on, you will need to alter the default setting (see “Settings” – “Lighting”).

If the door is left open at the end of a cooking process, the oven interior lighting will switch off automatically after 5 minutes.

The lighting can be switched on for 15 seconds by touching the  sensor control on the control panel.

Before using for the first time

Miele@home

Your combination steam oven is equipped with an integrated WiFi module.

To use this feature, you will need:

- A WiFi network
- The Miele app
- A Miele user account. You can create a user account via the Miele app

The Miele app will guide you as you connect your combination steam oven to your home WiFi network.

Once your combination steam oven is connected to your WiFi network, you can use the app for a number of actions, including the following:

- Call up information on the operating status of your combination steam oven
- Retrieve information on oven cooking processes that are in progress
- Stop cooking processes that are in progress

Connecting your combination steam oven to your WiFi network will increase energy consumption, even when the oven is switched off.

Make sure that the signal of your WiFi network is sufficiently strong in the place where your combination steam oven is installed.

Availability of the WiFi connection

The WiFi connection shares a frequency range with other appliances (including microwave ovens and remote control toys). This can give rise to sporadic or even complete connection failures. Therefore, the availability of featured functions cannot be guaranteed.

Miele@home availability

The ability to use the Miele app depends on the availability of the Miele@home service in your country.

The Miele@home service is not available in every country.

For information about availability, please visit www.miele.com.

Miele App

The Miele App is available to download free of charge from the Apple App Store® or from the Google Play Store™.



Basic settings

The following settings must be made before starting up for the first time. You can change these settings again at a later time (see “Settings”).

 Risk of injury caused by hot surfaces.

The combination steam oven gets hot during operation.

For safety reasons, the combination steam oven may only be used when it has been fully installed.

The combination steam oven will switch on automatically when it is connected to the electricity supply.

Setting the language

- Select the desired language.

If you have selected the wrong language by mistake, proceed as described in “Settings –  Language”.

Setting the location

- Select the required location.

Setting up Miele@home

Set up “Miele@home”? will appear in the display.

- To set up Miele@home now, select *Continue*.
- To set it up at a later date, select *Skip*. See “Settings – Miele@home” for information on setting up at a later date.
- To set up Miele@home now, select the desired connection method.

You will then be guided by the display and the Miele app.

Setting the date

- Set the day, then the month, and finally the year.
- Confirm with *OK*.

Setting the time

- Set the time of day in hours and minutes.
- Confirm with *OK*.

Before using for the first time

Setting the water hardness level

Contact your local water supplier to find out the hardness of the water in your area.

More information can be found under “Settings – Water hardness”.

- Select your local water hardness on the appliance.
- Confirm with *OK*.

Completing the commissioning process

- Follow any further instructions in the display.

The oven is now ready for use.

Cleaning the combination steam oven for the first time

- Remove any protective wrapping and stickers from the combination steam oven and accessories.



The combination steam oven is subjected to a functional test at the factory, which means that residual water from the pipes may run back into the oven compartment during transportation.

Cleaning the water container and condensate container

 Risk of injury caused by control panel.

You could get caught in the panel as it opens or closes.

Do not touch the upper edge of the door when the panel is opening and closing.

- Use the  On/Off sensor control to switch the combination steam oven on.
- Select the  sensor control to open the control panel.
- Remove the water container and condensate container. Remove the water container and condensate container by pushing it upwards slightly.
- Rinse the water container and condensate container by hand or in the dishwasher.

Before using for the first time

Cleaning accessories/oven compartment

- Take all accessories out of the oven compartment.
- Clean the cooking containers by hand or in the dishwasher.

The universal tray and combi rack surfaces are treated with PerfectClean and must **only** be washed by hand. See “PerfectClean” in “Cleaning and care”.

- Clean the universal tray and the combi rack with a clean absorbent cloth and a solution of hot water and washing-up liquid.

The interior of the combination steam oven has been treated at the factory with a care product.

- To remove this, clean the oven compartment with a clean absorbent cloth and a mild solution of washing-up liquid and hot water.

Setting the correct boiling point for water

Before cooking food for the first time, you must adjust the combination steam oven to the boiling temperature of the water, which varies depending on the altitude of where the combination steam oven is located. This process also flushes out the components of the appliance that carry water.

This procedure **must** be carried out to ensure efficient functioning of your appliance.

Distilled or carbonated water or other liquids could damage the combination steam oven.

Only use cold, fresh drinking water (below 20 °C).

- Remove the water container and fill it up to the maximum marker.
- Push the water container into the appliance.
- Then run the combination steam oven for 15 minutes using the Steam cooking  operating mode (100 °C). Proceed as described in “Operation”.

Setting the correct boiling point for water following a house move

If you move house, the boiling point for the water in the combination steam oven will need to be reset for the new altitude if this differs from the old one by 300 m or more. To do this, descale the appliance (“Cleaning and care” – “Care”).

Before using for the first time

Pre-heating the combination steam oven

- Take all accessories out of the oven compartment if applicable.
- To remove the grease from the ring heating element, heat the combination steam oven up at 200 °C using the Fan plus  operating mode for 30 minutes.
Proceed as described in “Operation”.

 Risk of injury caused by hot surfaces.





The combination steam oven gets hot during operation. You could burn yourself on the heater elements, oven compartment or side runners.

Use oven gloves when adjusting oven shelves etc. in a hot oven compartment.

The heater element will give off a slight smell when it is heated for the first time. The smell and any vapours given off will dissipate after a while and do not indicate a faulty connection or appliance.

Ensure that the kitchen is well ventilated during operation.

Settings overview

Menu option	Available settings
Language 	... deutsch english ... Location
Time	Display On* Off Night dimming Clock type Analogue* Digital Clock format 24 h* 12 h (am/pm) Set
Date	
Lighting	On "On" for 15 seconds* Off
Start screen	Main menu* Oven functions Automatic programmes Special applications User programmes MyMiele
Display	Brightness  Colour scheme Bright Dark* QuickTouch On Off*
Volume	Buzzer tones Melodies  Solo tone  Keypad tone  Welcome melody On* Off
Units	Weight g* lb lb/oz Temperature °C* °F

* Factory default setting

Settings

Menu option	Available settings
Keeping warm	On Off*
Steam reduction	On* Off
Recommended temps.	
Booster	On* Off
Automatic rinse	On* Off
Water hardness	1 °dH ... 15 °dH* ... 70 °dH
Movement sensor	Switch the light on during cooking process* Always on Off Switch appliance on On Off* Acknowledge buzzer On* Off
Safety	System lock  On Off* Sensor lock On Off*
Furniture front recognition	On Off*
Miele@home	Activate Deactivate Connection status Set up again Reset Set up
Remote control	On* Off
SuperVision	SuperVision display On Off* Display in standby On Only if there is a fault* Appliance list Display this appliance Buzzer tones

* Factory default setting

Menu option	Available settings
Remote Update	On* Off
Software version	
Legal information	Open source licences
Showroom programme	Demo mode On Off*
Factory default	Appliance settings User programmes MyMiele Recommended temps.

* Factory default setting

Settings

Opening the “Settings” menu

In the  Settings menu, you can personalise your combination steam oven by adapting the factory default settings to suit your requirements.

You are in the main menu.

- Select  Settings.
- Select the desired setting.



You can check settings or change them.

Settings cannot be changed while a cooking process is in progress.

Language

You can set your language and location.

After selecting and confirming your choice, the language you have selected will appear in the display.

Tip: If you have selected the wrong language by mistake, select  in the main menu. Follow the  symbol to get back to the Language  sub-menu.

Time

Display

Select how you want the time of day to be displayed when the combination steam oven is switched off:

- On
The time is always visible on the display.
If you also select the Display | Quick-Touch | On setting, all sensor controls react to touch straight away and the proximity sensor automatically detects when you approach the display. If you also select the Display | Quick-Touch | Off setting, the combination steam oven has to be switched on before it can be used.
- Off
To save energy, the display does not light up. The combination steam oven has to be switched on before it can be used.
- Night dimming
To save energy, the time only shows on the display between 5:00 a.m. and 11:00 p.m. The display remains dark at all other times.

Clock type

The time of day can be displayed as Analogue (with a clock face) or Digital (h:min) format.

With the digital display, the date is also shown.

Clock format

The time of day can be displayed in the 24 or 12-hour format (24 h or 12 h (am/pm)).

Set

Set the hours and the minutes.

Tip: If no cooking programme is in progress, touch the time in the header to change it.

If there is a power cut, the current time of day will reappear once power has been restored. The time of day is saved for approx. 150 hours.



If the combination steam oven has been connected to a WiFi network and signed into the Miele app, the time will be synchronised based on the location setting in the Miele app.

Date

Set the date.

When the combination steam oven is switched off, the date will only appear on the display if the Time | Clock type | Digital setting has been selected.

Lighting

- On
The oven interior lighting is switched on during the entire cooking period.
- "On" for 15 seconds
The oven interior lighting switches off 15 seconds after a cooking programme has begun. Press the  sensor control to switch the oven interior lighting on again for 15 seconds.
- Off
The oven interior lighting is switched off. Press the  sensor control to switch on the oven interior lighting for 15 seconds.

Settings

Start screen

The combination steam oven is factory-set for the main menu to appear when it is switched on. You can change this default setting so that, for instance, the operating modes or MyMiele settings appear in the start screen straight away (see “MyMiele”).



This new start screen will then appear when the combination steam oven is next switched on.

Select the  sensor control or follow the path in the header to get to the main menu.

Display

Brightness

The display brightness is represented by a bar with seven segments.

-  Maximum brightness
-  Minimum brightness

Colour scheme

Choose between a light or dark colour scheme for the display.

- Bright
The display has a light background with dark characters.
- Dark
The display has a dark background with white characters.

QuickTouch

Select how the sensor controls and the proximity sensor should respond when the combination steam oven is switched off:

- On
If you have also selected the Time | Display | On or Night dimming setting, the sensor controls and the proximity sensor will also respond when the combination steam oven is switched off.
- Off
Independently of the Time | Display setting, the sensor controls and proximity sensor only respond when the combination steam oven is switched on, as well as for a certain amount of time after switching it off.

Volume

Buzzer tones

If buzzers are switched on, a buzzer will sound when the set temperature is reached and at the end of a set time.

Melodies

At the end of a process, a melody will sound several times in intervals.

The volume of the melody is represented by a bar with seven segments.

- ■■■■■■■■
Maximum volume

- □□□□□□□
Melody is switched off

Solo tone

At the end of a process, a continuous tone will sound for a period of time.

The pitch of this continuous tone is represented by a segment bar.

- ■■■■■■■■■■■■■■■■■■■■
Maximum pitch

- ■□□□□□□□□□□□□□□
Minimum pitch

Keypad tone

The volume of the tone that sounds each time you touch a sensor control is represented by a bar with seven segments.

- ■■■■■■■■
Maximum volume

- □□□□□□□
Tone is switched off

Welcome melody

The melody that sounds when you touch the ⏻ On/Off sensor control can be switched on or off.

Units

Weight

For automatic programmes, you can set the weight of food in grams (g), pounds/ounces (lb) or pounds (lb/oz).

Temperature

You can set the temperature in degrees Celsius (°C) or degrees Fahrenheit (°F).

Settings

Keeping warm

Using the Keeping warm function, you can keep food warm at the end of a steam cooking programme. Food is kept warm at a pre-set temperature for a maximum of 15 minutes. You can cancel the keeping warm process by opening the door.

Please note that delicate food, especially fish, can continue cooking whilst being kept warm.

- On
The Keeping warm function is switched on. When cooking at a temperature of approx. 80 °C or above, this function is active after approx. 5 minutes. The food is kept warm at a temperature of 70 °C.
- Off
The Keeping warm function is switched off.

Steam reduction

The Steam reduction function stops excessive steam escaping when the door is opened.

- On
The steam reduction function will switch on automatically at the end of a cooking programme which uses a temperature of over approx. 80 °C (steam cooking) or 80–100 °C and 100 % moisture (combination cooking). Steam reduction will appear in the display.
- Off
If steam reduction is switched off, the Keeping warm function is also automatically switched off. With steam reduction switched off, a lot of steam will escape when the door is opened.

Recommended temps.

If you often cook with different temperatures, it makes sense to change the recommended temperatures.

After selecting this menu option, a list of operating modes will appear in the display.

- Select the relevant operating mode.

The recommended temperatures are displayed along with the available temperature range.

- Change the recommended temperatures.
- Confirm with *OK*.

Booster

The **Booster** function is used to quickly pre-heat the oven compartment.

- On
The **Booster** function is automatically switched on during the heating-up phase of a cooking programme. The top heat/grill element, ring heating element and hot air fan pre-heat the oven compartment to the desired temperature at the same time.
- Off
The **Booster** function is switched off during the heating-up phase of a cooking programme. Only the heating elements associated with the function are pre-heating the oven compartment.

You can also use the pull-down menu to switch the **Booster** function on or off for a cooking programme.

Automatic rinsing

Following a cooking process with steam, **Appliance rinsing** will appear on the display after the combination steam oven has been switched off.

This process flushes any remaining food deposits out of the system.

You can activate or deactivate the automatic rinsing process.

Settings

Water hardness

The combination steam oven must be adjusted to the local water hardness level to ensure that it works correctly and to ensure that descaling is carried out at the correct interval. The harder the water is, the more frequently the combination steam oven needs to be descaled.

Contact your local water supplier to find out the water hardness in your area.

If you use bottled water, such as mineral water, make sure it is not carbonated. Adjust this setting depending on the calcium content. The calcium content is specified on the label of the bottle in mg/l Ca²⁺ or ppm (mg Ca²⁺/l).

You can set the hardness level between 1 °dH and 70 °dH. The hardness level is set to 15 °dH by default.

Water hardness		Calcium content mg/l Ca ²⁺ or ppm (mg Ca ²⁺ /l)	Setting
°dH	mmol/l		
1	0.2	7	1
2	0.4	14	2
3	0.5	21	3
4	0.7	29	4
5	0.9	36	5
6	1.1	43	6
7	1.3	50	7
8	1.4	57	8
9	1.6	64	9
10	1.9	71	10
11	2.0	79	11
12	2.2	86	12

Water hardness		Calcium content mg/l Ca ²⁺ or ppm (mg Ca ²⁺ /l)	Setting
°dH	mmol/l		
13	2.3	93	13
14	2.5	100	14
15	2.7	107	15
16	2.9	114	16
17	3.1	121	17
18	3.2	129	18
19	3.4	136	19
20	3.6	143	20
21	3.8	150	21
22	4.0	157	22
23	4.1	164	23
24	4.3	171	24
25	4.5	179	25
26	4.7	186	26
27	4.9	193	27
28	5.0	200	28
29	5.2	207	29
30	5.4	214	30
31	5.6	221	31
32	5.8	229	32
33	5.9	236	33
34	6.1	243	34
35	6.3	250	35
36	6.5	257	36
37–45	6.6–8.0	258–321	37–45
46–60	8.2–10.7	322–429	46–60
61–70	10.9–12.5	430–500	61–70

Movement sensor

The proximity sensor detects when you approach the touch display, e.g. with your hand or body.

If you want the proximity sensor to respond even when the combination steam oven is switched off, select the Display | QuickTouch | On setting.

Switch the light on

- during cooking process
As soon as you approach the touch display during a cooking programme, the oven interior lighting switches on. The oven interior lighting automatically switches off again after 15 seconds.
- Always on
As soon as you approach the touch display, the oven interior lighting switches on. The oven interior lighting automatically switches off again after 15 seconds.
- Off
The movement sensor does not respond when you approach the touch display. Select the  sensor control to switch on the oven interior lighting for 15 seconds.

Switch appliance on

- On
If the time is displayed, the combination steam oven switches on and the main menu appears as you approach the touch display.
- Off
The proximity sensor does not respond when you approach the touch display. Use the  On/Off sensor control to switch the combination steam oven on.

Acknowledge buzzer

- On
As soon as you approach the touch display, the buzzers switch off.
- Off
The movement sensor does not respond when you approach the touch display. Switch the buzzers off manually.

Settings

Safety

System lock

The system lock prevents the combination steam oven from being switched on by mistake.

You can still set an alarm and a minute minder as well as use the MobileStart function when the system lock is active.

The system lock will remain activated even after a power failure outage.

- On
The system lock has been activated. If you want to use the combination steam oven, switch it on and touch the  symbol for at least 6 seconds.
- Off
The system lock is deactivated. You can use the combination steam oven as normal.

Sensor lock

The sensor lock prevents the cooking programme being switched off by mistake or settings being changed. Apart from the  On/Off sensor control, the activated sensor lock prevents the sensor controls and fields in the display from working a few seconds after a programme has been started.

- On
The sensor lock is activated. Touch *OK* for at least 6 seconds to deactivate the sensor lock for a short period of time.
- Off
The sensor lock is deactivated. All sensor controls react to touch as normal.

Furniture front recognition

- On

The furniture front detection is activated. Using the proximity sensor, the combination steam oven automatically detects whether the furniture door is closed.

If the furniture door is closed, the combination steam oven switches off automatically after a certain period.

- Off

The furniture front detection is deactivated. The combination steam oven does not detect whether the furniture door is closed.

If the combination steam oven is installed behind a decorative furniture front (e.g. a door), the combination steam oven, housing unit and the floor can be damaged by the build up of heat and moisture behind the closed furniture front.

Always leave the furniture door open when you are using the combination steam oven.

Leave the furniture door open until the combination steam oven has cooled down completely.

Tip: Turn off Furniture front recognition if you want to use the Sabbath programme.

Miele@home

The combination steam oven is a Miele@home-compatible domestic appliance with SuperVision functionality.

Your combination steam oven is fitted ex-works with a WiFi communication module and is suitable for wireless communication.

There are a number of ways of connecting your combination steam oven to your WiFi network. We recommend connecting your combination steam oven to your WiFi network with the help of the Miele app or via WPS.

- Activate

This setting is only visible if Miele@home is deactivated. The WiFi function is reactivated.

- Deactivate

This setting is only visible if Miele@home is activated. Miele@home remains set up; the WiFi function is switched off.

- Connection status

This setting is only visible if Miele@home is activated. The display shows information such as the WiFi reception quality, network name and IP address.

- Set up again

This setting is only visible if a WiFi network has already been set up. Reset the network settings and immediately set up a new network connection.

Settings

- Reset

This setting is only visible if a WiFi network has already been set up. The WiFi function is deactivated and the WiFi network connection will be reset to the factory default. You must set up a new WiFi network connection to be able to use Miele@home.

The network settings should be reset whenever a combination steam oven is being disposed of or sold, or if a used combination steam oven is being put into operation. This is the only way to ensure that all personal data has been removed and the previous owner will no longer be able to access the combination steam oven.

- Set up

This setting is only visible if no WiFi connection has been set up yet. You must set up a new WiFi network connection to be able to use Miele@home.

Remote control

If you have installed the Miele app on your mobile device, have access to the Miele@home system and have activated the remote control function (On), you can use the MobileStart function and, for example, retrieve information about combination steam oven cooking processes that are in progress or end a process that is in progress.

The combination steam oven requires max. 2 W in networked standby.

Activating MobileStart

- Select the  sensor control to activate MobileStart.

The  sensor control lights up. You can operate your combination steam oven remotely with the Miele app.

Directly operating the combination steam oven takes priority over operating it via the remote control function on the app.

You can use MobileStart as long as the  sensor control is lit up.

SuperVision

The combination steam oven is a Miele@home-compatible domestic appliance with SuperVision functionality for monitoring other domestic appliances in the Miele@home system.

The SuperVision function cannot be activated until the Miele@home system has been set up.

SuperVision display

- On
The SuperVision function is switched on.
The  symbol will appear in the top right-hand side of the display.
- Off
The SuperVision function is switched off.

Display in standby

The SuperVision function is also available when the oven is in standby. However, the time-of-day display must be switched on (Settings | Time | Display | On).

- On
Active household appliances that are signed into the Miele@home system are always displayed.
- Only if there is a fault
Only faults on active household appliances are shown.

Appliance list

All household appliances signed in to the Miele@home System are shown. Once you have selected an appliance, you can access further settings:

- Display this appliance
 - On
The SuperVision function for this appliance is switched on.
 - Off
The SuperVision function for this appliance is switched off. The appliance is still signed on to the Miele@home system. Faults are displayed, even if the SuperVision function for the appliance has been switched off.
- Buzzer tones
You can select whether the buzzers are switched on (On) or switched off (Off) for this appliance.

Settings

Remote Update

The Remote Update menu option is only displayed and can only be selected if the requirements for using Miele@home have been met (see “Before using for the first time – Miele@home”).

The RemoteUpdate function is used for updating the software in your combination steam oven. If an update is available for your combination steam oven, it will automatically download it. Updates will not be installed automatically. They must be initiated manually.

If you do not install an update, you can continue to use your combination steam oven as usual. However, Miele recommends installing updates.

Activating/deactivating

The RemoteUpdate function is activated as standard. Available updates will be downloaded automatically but will only be installed if you initiate installation manually.

Deactivate RemoteUpdate if you do not want any updates to be downloaded automatically.

Running a RemoteUpdate

Information about the content and scope of an update is provided in the Miele app.

A message will appear in your combination steam oven display if a software update is available.

You can install the update immediately or postpone this until later. When the combination steam oven is switched on again, you will be reminded about the update.

Deactivate RemoteUpdate if you do not want to install the update.

The update may take several minutes.

Please note the following information about the RemoteUpdate function:

- You will only receive a message when an update is available.
- Once an update has been installed, it cannot be undone.
- Do not switch the combination steam oven off during the update. Otherwise, the update will be aborted and will not be installed.
- Some software updates can only be carried out by the Miele Customer Service Department.

Software version

The software version is intended for the Miele Customer Service Department. You do not need this information for domestic use.

- Confirm with *OK*.

Legal information

You can find an overview of the integrated Open Source components under Open source licences.

- Confirm with *OK*.

Showroom programme

This function enables the combination steam oven to be demonstrated in showrooms without heating up. This setting is not needed for domestic use.

Demo mode

If you have demo mode activated, Demo mode switched on. The appliance will not heat up **will appear when you switch the combination steam oven on.**

- On
Touch *OK* for at least 4 seconds to activate demo mode.
- Off
Touch *OK* for at least 4 seconds to deactivate demo mode. You can use the combination steam oven as normal.

Factory default

- Appliance settings
Any settings that have been altered will be reset to the factory default settings.
- User programmes
All User programmes will be deleted.
- MyMiele
All MyMiele entries will be deleted.
- Recommended temps.
Any recommended temperatures that have been changed will be reset to the factory default settings.

Alarm + minute minder



Using the  sensor control, you can set a minute minder, e.g. for boiling eggs, or an alarm for a specific time.

Using the Alarm function

The  alarm can be used to specify a particular time for a buzzer to sound.

Setting the alarm

If you have selected the Display | Quick-Touch | Off setting, you will need to switch the combination steam oven on before setting the alarm. The alarm time will then appear on the display when the combination steam oven is switched off.

- Select the  sensor control.
- Select  Alarm.
- Set the time for the alarm.
- Touch **Close** to confirm.

When the combination steam oven is switched off, the alarm time and  will appear instead of the time of day.

If you are cooking at the same time or if you are in a different menu,  and the alarm time will appear at the top right-hand side of the display.

At the specified time for the alarm,  will flash on the display next to the time and a buzzer will sound.

- Select the  sensor control or the set alarm time on the display.

The buzzer will stop and the symbols on the display will go out.

Changing an alarm

- Select the alarm in the display or select the  sensor control and the desired alarm.

The set alarm time appears in the display.

- Set the new time for the alarm.
- Touch **Close** to confirm.

The adjusted alarm time is now saved and will appear in the display.

Deleting an alarm

- Select the alarm in the display or select the  sensor control and the desired alarm.

The set alarm time appears in the display.

- Select **Delete**.
- Touch **Close** to confirm.

The alarm will be deleted.

Using the Minute minder function

The  minute minder can be used to time other activities in the kitchen, e.g. boiling eggs.



The minute minder can also be used at the same time as a cooking programme for which the cooking duration start and finish times have been set (e.g. as a reminder to stir the food or add seasoning, etc.).

- The maximum minute minder time that can be set is 59 minutes and 59 seconds.

Setting the minute minder

If you have selected the **Display | Quick-Touch | Off** setting, you will need to switch the combination steam oven on before setting the minute minder. The minute minder can then be seen counting down on the display when the combination steam oven is switched off.

Example: you want to boil some eggs and set a minute minder duration of 6 minutes and 20 seconds.

- Select the  sensor control.
- Select  Minute minder.
- Set the minute minder time you require.
- Touch **Close** to confirm.

When the combination steam oven is switched off, the minute minder time counts down on the display and  appears instead of the time of day.

If you are cooking at the same time or if you are in a different menu, the minute minder duration and  will appear at the top right-hand side of the display.

At the end of the minute minder duration,  will flash, the time will start counting up and a buzzer will sound.

- Select the  sensor control or the desired minute minder on the display.

The buzzer will stop and the symbols on the display will go out.

Changing the minute minder duration

- Select the minute minder in the display or select the  sensor control and then the desired minute minder duration.

The minute minder duration selected will appear.

- Set a new minute minder duration.
- Touch **Close** to confirm.

The changed minute minder duration is now saved and will count down in minutes. Minute minder durations of less than 10 minutes will count down in seconds.

Deleting the minute minder duration





















- Select the minute minder in the display or select the  sensor control and then the desired minute minder duration.

The minute minder duration selected will appear.







- Select **Delete**.
- Touch **Close** to confirm.

The minute minder duration is now deleted.

Main and sub-menus





Menu	Recommended value	Range
Oven functions 		
Fan plus 	160 °C	30–230 °C
Conventional heat 	180 °C	30–230 °C
Combi mode 		
Combi Fan plus 	170 °C	30–230 °C
Combi Conventional 	180 °C	30–230 °C
Combi Grill 	Level 3	Level 1–3
Steam cooking 	100 °C	40–100 °C
Sous-vide 	65 °C	45–90 °C
Intensive bake 	180 °C	50–230 °C
Bottom heat 	190 °C	100–200 °C
Top heat 	190 °C	100–230 °C
Full grill 	Level 3	Level 1–3
Economy grill 	Level 3	Level 1–3
Fan grill 	200 °C	50–230 °C
Cake plus 	160 °C	30–230 °C
Eco Fan heat 	180 °C	30–230 °C
Eco Steam cooking 	100 °C	40–100 °C
Automatic programmes 		
Special applications 		
Reheat	130 °C	120–140 °C
Defrost	60 °C	50–60 °C

Main and sub-menus

Menu	Recommended value	Range
Special applications 		
Mix & Match		
Crispy cooking	-	-
Gentle cooking	-	-
Crispy reheating	-	-
Gentle reheating	-	-
Blanching	-	-
Bottling	90 °C	80–100 °C
Drying	50 °C	30–70 °C
Prove dough	-	-
Menu cooking	-	-
Disinfect items	-	-
Sabbath programme	180 °C	50–230 °C
Heat crockery	50 °C	50–80 °C
Keeping warm	65 °C	40–100 °C
MyMiele  		
User programmes 		
Settings 		
Maintenance 		
Descalc		
HydroClean		
Soak		
Drying		
Rinse		

Energy saving tips

Cooking programmes

- If possible, use the automatic programmes for cooking food.
- Remove all accessories from the oven compartment that are not required for cooking.
- In general, if a range of temperatures is given in a recipe or chart, it is best to select the lower temperature and to check the food after the shortest duration.
- Preheat the oven only if instructed to do so in the recipe or the cooking chart.
- If possible, do not open the door during a cooking programme.
- Dark, matt tins are best for baking. They absorb the heat more effectively and transmit it to the mixture more quickly. Shiny materials such as stainless steel or aluminium reflect the heat and therefore can give a more uneven result. Do not cover the oven floor or the rack with heat-reflecting aluminium foil.
- Monitor cooking durations to avoid wasting energy when cooking. Set the cooking duration, or use a food probe if you have one.
- The Fan plus  operating mode can be used for cooking many types of food. Because the fan distributes the heat in the oven compartment straight away, it allows you to use a lower temperature than you would with Conventional heat . It also enables you to cook on multiple shelf levels at the same time.
- Fan grill  is the best operating mode for grilled dishes. With this operating mode, you can use lower temperatures than in other grill operating modes which use the maximum temperature setting.
- The Eco Fan heat  operating mode ensures energy-efficient cooking thanks to optimal utilisation of heat. Use this operating mode for cooking small amounts of food, e.g. frozen pizzas or biscuits. Do not open the door during the cooking process.
- You can use the Eco Steam cooking  operating mode to save energy during steam cooking. This operating mode is particularly suitable for cooking fish and vegetables.
- Whenever possible you should cook multiple foods at the same time. Place them next to each other in the oven or on different shelf levels.
- Foods which you are unable to cook at the same time should, if possible, be cooked one after the other in order to make use of existing heat in the oven.

Settings

- Select the setting **Display | Quick-Touch | Off** for the control elements in order to reduce energy consumption.
- Select the **Lighting | Off** or **“On” for 15 seconds** setting for the oven interior lighting. The oven interior lighting can be switched on again at any time by touching the  sensor control.

Energy-saving mode

The combination steam oven will switch itself off automatically to save energy if a cooking process is not being run and controls have not been operated. The time of day will appear on the display or the display will remain dark (see “Settings”).

Operation

Malfunction due to missing floor filter.

If the floor filter is missing, food deposits can get into the drain. The water cannot be pumped away.

Before each cooking programme, check that the filter in the floor of the oven compartment is correctly fitted.

- Switch the combination steam oven on.

The main menu will appear.

- If you want to cook using a steam operating mode or bursts of steam, fill the water container and insert it into the appliance.

Distilled or carbonated water or other liquids could damage the combination steam oven.

Only use cold, fresh drinking water (below 20 °C).

- Place the food in the oven compartment.
- Select Oven functions .
- Select the relevant operating mode.

The operating mode and recommended values for temperature and moisture (if applicable) appear.

- Change the recommended values if necessary.

The recommended values will be automatically accepted within a few seconds. You can change the temperature and moisture level later by selecting the temperature or moisture indicator.

- Confirm with *OK*.

The required and the actual temperature will appear and the heating-up phase will begin.

You will see the temperature increasing. A buzzer will sound when the set temperature is reached for the first time.

- After the cooking process, select *Finish*.

 Risk of injury caused by hot steam.

When using a cooking process involving steam, a lot of hot steam can escape if the door is opened. The steam can cause burns.

Step back and wait until the hot steam has dissipated.

- Take the food out of the oven compartment.

Cleaning the combination steam oven after a cooking process

- Remove the water container and condensate container and empty them as required.
- Switch the combination steam oven off.

Appliance rinsing appears after a cooking process involving steam.

- Follow the instructions on the display.

The rinsing process should be carried out every time to flush any remaining food deposits out of the system.

- Clean and dry the whole combination steam oven as described in “Cleaning and care”.
- Leave the appliance door open until the oven compartment is completely dry.

Refilling the water

If water needs replenishing during the programme, a tone will sound and the display will prompt you to refill the container with fresh water.

- Take out the water container and replenish the water.
- Push the water container into the appliance.

The cooking programme is resumed.

Changing values and settings for a cooking programme

Depending on the function, as soon as a cooking programme is in progress, you can change the values or settings for this programme.

Depending on the function, you can change the following settings:

- Temperature
- Moisture
- Duration
- Booster
- Pre-heat
- Crisp function

Operation

Changing the temperature and core temperature

Go to Settings | Recommended temps. to permanently adjust the recommended temperatures to suit your cooking preferences.

The  core temperature only appears if you are using the food probe (see “Roasting – Food probe”).

- Touch the temperature display.
- Change the temperature and the  core temperature if necessary.
- Confirm with *OK*.

The cooking programme will restart with the new desired temperatures.

Changing the Moisture

- Touch the moisture indicator.
- Change the moisture level.
- Confirm with *OK*.

The programme will continue to run at the new moisture level.

Setting cooking durations

Cooking results can be impaired if there is a long delay between the food being placed in the oven and the start of cooking. Fresh food can change colour and even deteriorate. When baking, the cake mixture or dough can dry out, and the raising agents can lose their effectiveness. Select as short as possible a time until the cooking programme starts.

You have placed the food in the oven compartment, selected an operating mode and the required settings such as the temperature.

By entering *Duration*, *Finish at* or *Start at*, you can automatically switch the cooking process off or on and off.

- *Duration*
Enter the required cooking duration for the food. The heating will switch off automatically once this duration has elapsed. The maximum cooking duration that can be set depends on the operating mode that you have selected.
- *Finish at*
Specify when you want the cooking process to end. The oven heating will switch off automatically at the time you have set.

- Start at
This function will only appear in the menu if you have set a Duration or Finish at time. With Start at, you have to specify when you want the cooking process to start. The oven heating will switch on automatically at the time you have set.
- Select ⊕ or Timer.
- Set the desired times.
- Confirm with OK.

When cooking with steam, the cooking duration does not begin until the set required temperature is reached.

The steam reduction function will switch on at the end of a cooking programme which used a temperature of over approx. 80 °C (steam cooking) or 80–100 °C and 100 % moisture (combination cooking).

- Wait until Steam reduction goes out in the display before opening the door and removing the food from the oven compartment.

Changing the set cooking durations

- Select ⊕, the duration or Timer.
- Select the desired time and change it.
- Confirm with OK.

These settings will be deleted in the event of a power failure.

Deleting the set cooking durations

- Select ⊕, the duration or Timer.
- Select the desired time.
- Select Delete.
- Confirm with OK.

If you delete Duration, the set times for Finish at and Start at are also deleted.

If you delete Finish at or Start at, the cooking programme will start using the cooking duration set.

Operation

Cancelling a cooking programme

If you cancel a cooking programme, the oven heating and lighting will switch off. Any cooking durations set will be deleted.

Cancelling a cooking programme without a set cooking duration

- Select Finish.

The main menu will appear.

Cancelling a cooking programme with a set cooking duration

- Select Cancel.

Cancel process? appears in the display.

- Select Yes.

The main menu will appear.

Interrupting a cooking process

A cooking process is interrupted as soon as the door is opened. The oven heating switches off.

The set cooking duration is saved when cooking with steam as well as for programmes and applications with pure steam operation.

 Risk of injury caused by hot steam.

When using a cooking process involving steam, a lot of hot steam can escape if the door is opened. The steam can cause burns.

Step back and wait until the hot steam has dissipated.

 Risk of injury caused by hot surfaces and food.

The combination steam oven gets hot during operation. You could burn yourself on the heater elements, oven compartment, side runners, accessories or food.

Use oven gloves when placing hot food in the appliance or removing it and when adjusting oven shelves etc. in a hot oven compartment.

When placing cooking containers into the oven or removing them, make sure that the hot food does not spill out.

The cooking process will resume when the door is closed.

The combination steam oven will heat up again and the display will show the temperature in the oven compartment as it rises.

When cooking with steam as well as for programmes and applications with pure steam operation, the time left only continues to elapse once the set temperature has been reached.

In programmes using 100 % moisture and temperatures up to 100 °C: the cooking process will finish early if the door is opened in the last minute of cooking (55 seconds remaining).

Pre-heating the oven compartment

The **Booster** function is used to quickly pre-heat the oven compartment in some functions.



The **Pre-heat** function can be used with any oven function (except **Eco Fan heat** ) and has to be switched on separately for each cooking programme.

It is only necessary to pre-heat the oven compartment in a few instances.

- Pre-heat the oven compartment when cooking the following food:
 - Cakes and pastries with a short cooking duration (approx. 30 minutes or less) as well as delicate items (e.g. sponge) with the **Conventional heat**  function

Booster

The **Booster** function is switched on as the factory default setting for the following functions (**Settings | Booster | On**):

- Fan plus 
- Conventional heat 

If you set a temperature above 100 °C and the **Booster** function is switched on, a rapid heating-up phase heats the oven to the set temperature. The top heat/grill element and the ring heater element come on together with the fan.

Delicate items (e.g. sponge or biscuits) will brown too quickly on the top if the **Booster** function is used. Switch off the **Booster** function for these items.

Switching the Booster on and off for a cooking programme

If you have selected the **Booster | On** setting, you can switch off the function separately for a cooking programme.

On the other hand, you can also switch on the function separately for a cooking programme if you have selected the **Booster | Off** setting.

Example: you have selected a function and the required settings such as the temperature.

You want to switch off the **Booster** function for this cooking programme.

- Drag down the pull-down menu.

Booster is highlighted in orange.

- Select **Booster**.

Depending on the colour scheme, **Booster** is highlighted either in black or white.

- Close the pull-down menu.

The **Booster** function is switched off during the heating-up phase. Only the heating elements associated with the function are pre-heating the oven compartment.

Operation

Pre-heat

You can place most dishes in the cold oven compartment to make use of the heat produced during the heating-up phase.

If you have set a cooking duration, it will only start to count down when the desired temperature is reached and you have placed the food in the oven.

Start the cooking programme immediately without delaying the start time.

Switching on Pre-heat

The Pre-heat function has to be switched on separately for each cooking process.

Example: you have selected an operating mode and the required settings such as the temperature.

You want to switch on the Pre-heat function for this cooking process.

■ Drag down the pull-down menu.

Depending on the colour scheme, Pre-heat is highlighted in either black or white.

■ Select Pre-heat.

Pre-heat is highlighted in orange.

■ Close the pull-down menu.

The following message is displayed with a time: Place food in the oven at . The oven compartment is heated to the set temperature.

■ As soon as you are prompted to do so, place the food in the oven compartment.

■ Confirm with OK.







Crisp function

The Crisp function (moisture reduction) allows moisture to be removed from the oven as required during the entire cooking process or at times during the process.

It is a good idea to use this function when cooking items which have a moist topping e.g. quiche, pizza, tray bakes with fresh fruit toppings or muffins.

Poultry in particular gets a good crisp skin with this function.

The Crisp function can be used in the following functions:

- Fan plus 
- Conventional heat 
- Intensive bake 
- Bottom heat 
- Top heat 
- Fan grill 
- Cake plus 

Switching on Crisp function

The Crisp function function has to be switched on separately for each cooking programme.

You have selected a function and the required settings such as the temperature.

You want to switch on the Crisp function function for this cooking programme.

- Drag down the pull-down menu.

Depending on the colour scheme, Crisp function is highlighted in either black or white.

- Select Crisp function.

Crisp function is highlighted in orange.

- Close the pull-down menu.

The Crisp function function is switched on.

The Crisp function function can be switched off again at any time via the pull-down menu.

Releasing bursts of steam

You can release bursts of steam during the cooking process in all oven functions (except Eco Fan heat ). The number of bursts of steam is unlimited.

You can release a burst of steam as soon as Burst of steam appears and Start is shown in green.

Please wait until the heating-up phase is completed to allow the steam to be distributed evenly by the warm air in the oven.

- Select Start.

The steam will be released. It will take approximately 1 minute.

- Proceed as described to release further bursts of steam once Start is shown in green again.

Operation

Changing the function

You can change to another function during a cooking programme.

- Touch the symbol for the selected function.
- If you have set a cooking duration, confirm the **Cancel process?** message with **Yes**.
- Select the new function.

The new function appears in the display with its corresponding recommended values.

- Set the values for the cooking programme and confirm with **OK**.

This section contains general information. You will find more detailed information about particular foods and how to cook them in the other sections.

The advantages of cooking with steam

Almost all vitamins and minerals are retained as the food is not immersed in water.

Cooking with steam also retains the true taste of the food better than conventional cooking. We therefore recommend seasoning the food after it has been cooked. Food also retains its fresh, original colour.

Suitable containers

Cooking containers

Stainless steel cookware is provided with the combination steam oven. Other containers, in a variety of sizes, both perforated and solid, are available as optional extras (see “Optional accessories”). This enables you to choose the most suitable container for the dish you are preparing.

Use perforated cooking containers for **steam cooking** if possible. The steam can reach the food from all sides and the food is cooked evenly.

Your own containers

You can also use your own containers. However, please note the following:

- Containers must be suitable for use in an oven and able to withstand steam. With plastic containers, please check with the manufacturer that they are suitable for use in a steam oven.
- Thick-sided containers such as porcelain, ceramic or stoneware are not very suitable for using with steam. Due to their thick sides, they do not conduct heat well, meaning cooking durations will be considerably longer than those given in the charts.
- Place the containers on the rack or on a suitable tray. Depending on the size of the container, you can also place the rack on the floor of the oven compartment with the rack surface facing up and the cooking container on top. You can also take the side runners out to make more room (see “Cleaning the side runners” in the “Cleaning and care” chapter).
- Ensure that there is a gap between the upper rim of the container and the top of the oven compartment to allow sufficient steam into the container.

General notes

Shelf level

You can select any shelf level. You can also cook on several levels at the same time. This will not alter the cooking duration.

When using more than one deep container at the same time for steam cooking it is best to offset them on their runners and to leave at least one level free in between them.

Always insert cooking containers, the rack and the tray between the rails of the side runners so that they cannot tip.

Frozen food

The heating up phase for frozen food is longer than for fresh food. The greater the quantity of frozen food, the longer the heating up phase.

Temperature

During steam cooking, the temperature does not exceed 100 °C. Almost all foods can be cooked at this temperature. Some types of food, such as berries, need to be cooked at lower temperatures to prevent them from bursting. See the relevant sections in these operating instructions for more details.

Cooking duration

During steam cooking, the cooking duration does not begin until the set temperature is reached.

In general, the cooking durations for cooking with steam are the same as for cooking food in a saucepan. More information about any factors which may affect the cooking duration is given in the relevant sections.

The quantity of food does not affect the cooking duration. 1 kg of potatoes will take the same time to cook as 500 g.

Cooking with liquid

When cooking with liquid only fill the cooking container $\frac{2}{3}$ full to prevent the liquid spilling when the cooking container is removed from the oven.

Your own recipes – steam cooking

Food which is cooked in a pot or a pan can also be cooked in the combination steam oven. The cooking durations in the combination steam oven will be the same. Please note that food will not be brown or crisp when cooking with steam.

Universal tray and combi rack

Use the universal tray with the combi rack placed on top of it, e.g. for roasting and grilling. During roasting, you can use the meat juices collected in the tray to make a gravy or sauce.

If you are using the universal tray with the combi rack on top, insert the universal tray between the rails of a shelf level and the combi rack will automatically slide in above them. When removing them from the oven, pull both out together.

Non-tip safety notches

The combi rack and universal tray have non-tip safety notches which prevent them being pulled right out when they only need to be partially pulled out. The tray and rack can then only be taken out of the oven by raising them upwards and then pulling them out.

Steam cooking

Eco Steam cooking

You can use the Eco Steam cooking  function to save energy during steam cooking. This function is suitable mainly for cooking fish and vegetables.

We recommend following the cooking durations and temperatures from the tables specified in “Steam cooking”. You can cook for longer if necessary.

When cooking starchy foods such as potatoes, rice and pasta, the best function to use is Steam cooking .

Settings

Oven functions | Eco Steam cooking 

Notes on the cooking tables

Follow the instructions on cooking durations, temperatures and cooking notes.

Selecting the cooking duration

The cooking durations given are guidelines only.

- We recommend selecting the shorter duration initially. You can cook for longer if necessary.

Vegetables

Fresh

Prepare fresh vegetables in the usual way, i.e. wash, clean and cut them up.

Frozen food

Frozen vegetables do not need to be defrosted beforehand, unless they have been frozen together in a block.

Frozen and fresh vegetables which take the same length of time to cook can be cooked together.

If vegetables have frozen together in clumps, break these up before cooking with steam. Follow the manufacturer's instructions on the packaging regarding cooking duration.

Cooking containers

Food such as peas or asparagus spears, which have little or no space between them, will take longer to cook because the steam has less space to work in. For an even result, it is best to use a shallow container for these types of food, and only fill it about 3-5 cm deep. When cooking large quantities divide the food between 2 or 3 shallow containers rather than using one deep one.

Different types of vegetables which take the same length of time to cook can be cooked together.

Use solid containers for vegetables which are cooked in liquid.

Shelf level

To avoid any colour transfer when cooking vegetables with a distinctive colour (e.g. beetroot) in a perforated container, do not place other food underneath the perforated container.

Cooking duration

The cooking duration depends on the size of the food and how well cooked you want it, just as it does with conventional cooking methods. Example:

Waxy potatoes, cut into quarters:
approx. 17 minutes

Waxy potatoes, cut in half:
approx. 20 minutes

Settings

Automatic programmes  | Vegetables
| ... |

or

Oven functions  | Steam cooking 

Temperature: 100 °C

Cooking duration: see table

Steam cooking

Vegetables	 [min]
Artichokes	32–38
Cauliflower, whole	27–28
Cauliflower, florets	8
Beans, green	10–12
Broccoli, florets	3–4
Chantenay carrots, whole	7–8
Chantenay carrots, halved	6–7
Chantenay carrots, chopped	4
Chicory, halved	4–5
Chinese cabbage, chopped	3
Peas	3
Fennel, halved	10–12
Fennel, sliced	4–5
Kale, chopped	23–26
Waxy potatoes, peeled whole halved quartered	27–29 21–22 16–18
Mainly waxy potatoes, peeled whole halved quartered	25–27 19–21 17–18
Floury potatoes, peeled whole halved quartered	26–28 19–20 15–16
Kohlrabi, cut into batons	6–7
Pumpkin, diced	2–4
Corn on the cob	30–35
Chard, chopped	2–3

Steam cooking

Vegetables	 [min]
Peppers, diced or sliced	2
New potatoes, firm	30–32
Mushrooms	2
Leeks, sliced	4–5
Leeks, halved lengthways	6
Romanesco, whole	22–25
Romanesco, florets	5–7
Brussels sprouts	10–12
Beetroot, whole	53–57
Red cabbage, chopped	23–26
Black salsify, whole	9–10
Celeriac, cut into batons	6–7
Asparagus, green	7
Asparagus, white, whole	9–10
Carrots, chopped	6
Spinach	1–2
Spring cabbage, chopped	10–11
Celery, chopped	4–5
Swede, chopped	6–7
White cabbage, chopped	12
Savoy cabbage, chopped	10–11
Courgettes, sliced	2–3
Sugar snap peas	5–7

 Cooking duration

Steam cooking

Fish

Fresh

Prepare fresh fish in the usual way, i.e. clean, gut and fillet.

Frozen food

Fish does not need to be fully defrosted before cooking. Defrost so that the surface is sufficiently thawed to take herbs and seasoning. Depending on the thickness of the fish, 2 - 5 minutes should be enough.

Preparation

Add some lemon or lime juice to fish before cooking. The citric acid helps the flesh stay firm.

It is not necessary to season fish with salt when cooking with steam as this method retains the minerals which give the fish its unique flavour.

Cooking containers

If using a perforated container, grease it first.

Shelf level

When cooking fish in a perforated container at the same time as cooking other types of food in other containers, place the container with the fish directly above the universal tray to catch any liquid and so avoid any transfer of tastes to other food.

Temperature

85 °C – 90 °C

For gently cooking delicate types of fish, such as sole.

100 °C

For cooking firmer types of fish, e.g. cod and salmon.
Also for cooking fish in sauce or stock.

Duration

The cooking duration depends on the thickness and the texture of the fish, and not on the weight. The thicker the fish, the longer the cooking duration. A 3 cm thick piece of fish weighing 500 g will take longer to cook than a 2 cm thick piece of fish weighing 500 g.

The longer fish cooks, the firmer its flesh will become. Use the cooking durations given in the chart. If you find that the fish is not cooked sufficiently only cook it for a few minutes more.

When cooking fish in sauce or stock, we recommend that you increase the cooking duration quoted by a few minutes.

Tips

- Adding herbs and spices, such as dill, will help bring out the full flavour of the fish.
- Cook large fish in swimming position. To help maintain the shape of the fish, place a small cup or similar upside down in the cooking container, and arrange the fish belly-side down over the cup.
- You can use any fish scraps, e.g. fish heads, bones, tails etc to make a **fish stock**. Place the fish scraps together with some mixed vegetables in a solid cooking container and add cold water. Cook at 100 °C for 60 to 90 minutes. The longer the cooking duration, the stronger the stock.
- Preparing fish **au bleu** is a method involving cooking the fish in water with vinegar, at different proportions depending on the recipe. It is important not to damage the skin of the fish. This method is suitable for cooking carp, trout, tench, eel and salmon.

Settings

Automatic programmes Auto | Fish | ... |
Steam cooking

or

Oven functions | Steam cooking
Temperature: see table
Cooking duration: see table

Steam cooking

Fish	🌡️ [°C]	🕒 [min]
Eel	100	5–7
Perch fillet	100	8–10
Seabream fillet	85	3
Trout, 250 g	90	10–13
Halibut fillet	85	4–6
Cod fillet	100	6
Carp, 1.5 kg	100	18–25
Salmon fillet	100	6–8
Salmon steak	100	8–10
Salmon trout	90	14–17
Basa fillet	85	3
Rosefish fillet	100	6–8
Haddock fillet	100	4–6
Plaice fillet	85	4–5
Monkfish fillet	85	8–10
Sole fillet	85	3
Turbot fillet	85	5–8
Tuna fillet	85	5–10
Pike perch fillet	85	4

🌡️ Temperature 🕒 Duration

Meat

Fresh

Prepare the meat in the usual way.

Frozen food

Meat should be thoroughly defrosted before cooking in the steam oven (see “Special applications” – “Defrost”).

Preparation

For meat which needs to be seared before being cooked, e.g. for a stew, sear the meat in a pan on the hob first.

Duration

The cooking duration depends on the thickness and the texture of the meat, and not on the weight. The thicker the piece of meat, the longer the cooking duration. A piece of meat weighing 500 g which is 10 cm thick will take longer to cook than a piece of meat weighing 500 g which is 5 cm thick.

Tips

- To retain the **flavour**, use a perforated cooking container. Place a solid cooking container or the universal tray underneath in order to collect the concentrate. You can use the concentrate to enhance your sauces or freeze it for later use.
- Boiling meat from chicken and beef as well as meat bones can be used to make a **strong stock**. Place the meat together with the bones and some mixed vegetables in a cooking container and add cold water. The longer the cooking duration, the stronger the stock.

Settings

Automatic programmes Auto | Meat | ... |
Steam cooking

or

Oven functions | Steam cooking

Temperature: 100 °C

Cooking duration: see table

Steam cooking

Meat	🕒 [min]
Leg steak, covered with water	110–120
Pork knuckle	135–140
Chicken breast	8–10
Hock	105–115
Top rib, covered with water	110–120
Veal strips	3–4
Gammon slices	6–8
Lamb stew	12–16
Poularde	60–70
Turkey roulades	12–15
Turkey escalopes	4–6
Short rib, covered with water	130–140
Beef goulash	105–115
Whole chicken, covered with water	80–90
Topside	110–120

🕒 Cooking duration

Rice

Rice swells when cooked and needs to be cooked in liquid. The proportion of rice to liquid will vary depending on the type of rice.

The rice absorbs all the liquid during the cooking process and so none of the nutrients are lost.

Cooking container

Use a solid cooking container. Alternatively, smaller quantities of rice (up to a cup, approx. 50–150 g) can also be cooked in a suitable stainless steel bowl on the rack.

Preparation

Wash the rice before cooking. If you wash the rice in the cooking container, drain the water off carefully afterwards.

Tip: The required volume of liquid can be determined using scales or the cup method.

For the cup method, fill a cup with the desired quantity of rice and then place the rice in the cooking container. Then measure the required volume of liquid (see chart) with the cup and add it to the rice.

Make sure that the rice is evenly distributed in the cooking container.

Settings



Automatic programmes  | Rice | ... |



or

Oven functions  | Steam cooking 

Temperature: 100 °C

Cooking duration: see table

	 : 	 [min]
Long-grain rice		
Basmati rice	1 : 1.5	15
Parboiled rice	1 : 1.5	23–25
Brown rice	1 : 1.5	26–29
Wild rice	1 : 1.5	26–29
Short-grain rice		
Pudding rice	1 : 2.5	30
Risotto	1 : 2.5	18–19

 :  Ratio of rice to liquid,  Cooking duration

Steam cooking

Grain

Grains swell when cooked and need to be cooked in liquid. The proportion of grains to liquid depends on the type of grain.

Grains can be cooked whole or cracked.

Settings

Automatic programmes Auto | Grain | ... |

or

Oven functions | Steam cooking

Temperature: 100 °C

Cooking duration: see table

	Ratio Grain : Liquid	🕒 [min]
Amaranth	1 : 1.5	15–17
Bulgur	1 : 1.5	9
Green spelt, whole	1 : 1	18–20
Green spelt, cracked	1 : 1	7
Oats, whole	1 : 1	18
Oats, cracked	1 : 1	7
Millet	1 : 1.5	10
Polenta	1 : 3	10
Quinoa	1 : 1.5	15
Rye, whole	1 : 1	35
Rye, cracked	1 : 1	10
Wheat, whole	1 : 1	30
Wheat, cracked	1 : 1	8

🕒 Duration

Pasta

Dry pasta

Dry pasta swells when it is cooked and needs to be cooked in liquid. The liquid must cover the pasta. Using hot liquid gives better results.

Increase the cooking time stated by the manufacturer by approx. $\frac{1}{3}$.

Fresh food

Fresh pasta, such as the kind you can buy from the supermarket chilled counter, does not need to absorb water. Cook fresh pasta in a greased perforated container.

Separate any pieces of pasta which have stuck together and spread them out in the cooking container.

Settings

Automatic programmes Auto | Pasta | ... |

or

Oven functions | Steam cooking

Temperature: 100 °C

Cooking duration: see table

Fresh	🕒 [min]
Gnocchi	2
Knöpfli	1
Ravioli	2
Spätzle	1
Tortellini	2
Dry pasta, covered with water	
Tagliatelli	14
Vermicelli	8

🕒 Duration

Steam cooking

Dumplings

Ready made boil-in-the-bag dumplings need to be well covered with water as otherwise they can fall apart. This is because even though they have been soaked in water beforehand they will not absorb enough moisture.

Cook fresh dumplings in a greased, perforated container.

Settings

Automatic programmes Auto | Pasta | ... |

or

Oven functions | Steam cooking

Temperature: 100 °C

Cooking duration: see table

	 [min]
Sweet dumplings	30
Yeast dumplings	20
Boil-in-the-bag potato dumplings	20
Boil-in-the-bag bread dumplings	18–20

 Duration

Dried pulses

Soak pulses for at least 10 hours in cold water before cooking. Soaking makes the pulses more digestible and shortens the cooking duration required. Soaked pulses must be covered with liquid during cooking.

Lentils do not need to be soaked before cooking.

With unsoaked pulses a certain ratio of pulses to liquid is required depending on variety.

Settings

Automatic programmes Auto | Pulses | ... |

or

Oven functions | Steam cooking

Temperature: 100 °C

Cooking duration: see table

Soaked	
	🕒 [min]
Beans	
Kidney beans	55–65
Adzuki beans	20–25
Black beans	55–60
Pinto beans	55–65
Haricot beans	34–36
Peas	
Yellow split peas	40–50
Green split peas	27

🕒 Duration

Steam cooking

Unsoaked		
	Ratio Pulses : Liquid	🕒 [min]
Beans		
Kidney beans	1 : 3	130–140
Adzuki beans	1 : 3	95–105
Black beans	1 : 3	100–120
Pinto beans	1 : 3	115–135
Haricot beans	1 : 3	80–90
Lentils		
Brown lentils	1 : 2	13–14
Red lentils	1 : 2	7
Peas		
Yellow split peas	1 : 3	110–130
Green split peas	1 : 3	60–70

🕒 Duration

Hen's eggs

Use a perforated container to boil eggs in the steam oven.

The eggs do not need to be pierced before cooking as they are gradually warmed during the heating up phase and so do not burst when they are cooked with steam.

When using a solid container for making egg dishes such as scrambled eggs, remember to grease it first.

Settings

Automatic programmes Auto | Hen's eggs | ... |

or

Oven functions | Steam cooking

Temperature: 100 °C

Cooking duration: see table

	 [min]
Small soft medium hard	3 5 9
Medium soft medium hard	4 6 10
Large soft medium hard	5 6-7 12
Extra large soft medium hard	6 8 13

 Duration

Steam cooking

Fruit

Cook fruit in a solid container so that none of the juice is lost. If you wish to cook fruit in a perforated container, place a solid container directly underneath it to collect the juice.

Tip: You can use the juice which has collected in the solid container to make a glaze for a fruit flan.

Settings

Automatic programmes Auto | Fruit | ... |

or

Oven functions | Steam cooking

Temperature: 100 °C

Cooking duration: see table

	🕒 [min]
Apple chunks	1–3
Pear chunks	1–3
Cherries	2–4
Mirabelle plums	1–2
Nectarine/peach chunks	1–2
Plums	1–3
Quinces, diced	6–8
Rhubarb chunks	1–2
Gooseberries	2–3

🕒 Cooking duration

Sausages

Settings

Automatic programmes Auto | Sausages | ... |

or

Oven functions | Steam cooking

Temperature: 90 °C

Cooking duration: see table

Sausages	🕒 [min]
Frankfurters	6–8
Bologna sausages	6–8
Veal sausages	6–8

🕒 Duration

Shellfish

Preparation

Defrost frozen shellfish before cooking with steam.

Peel, remove and discard the intestines, and then wash the shellfish.

Cooking containers

If using a perforated container, grease it first.

Duration

The longer shellfish are cooked, the tougher they become. Use the cooking durations given in the chart.

When cooking shellfish in sauce or stock, we recommend that you increase the cooking duration quoted by a few minutes.

Settings



Automatic programmes  | Shellfish | ... |

or

Oven functions  | Steam cooking 

Temperature: see table

Cooking duration: see table

	 [°C]	 [min]
Crevettes	90	3
Prawns	90	3
King prawns	90	4
Small shrimps	90	3
Lobster	95	10–15
Large shrimps	90	3

 Temperature  Duration

Steam cooking

Mussels

Fresh food

 Danger of food poisoning from spoiled mussels.
Spoiled mussels can cause food poisoning.
Only cook mussels which are closed.
Do not eat mussels which have not opened after being cooked.

Steep fresh mussels in water for a few hours before cooking to rinse out any sand. Then scrub the mussels thoroughly to clean them.

Frozen food

Defrost frozen mussels before cooking.

Duration

The longer mussels are cooked, the tougher they become. Use the cooking durations given in the chart.

Settings



Automatic programmes Auto | Mussels and clams | ... |

or

Oven functions | Steam cooking

Temperature: see table

Cooking duration: see table

	 [°C]	 [min]
Barnacles	100	2
Cockles	100	2
Mussels	90	12
Scallops	90	5
Razor clams	100	2–4
Venus clams	90	4

 Temperature  Duration

Menu cooking (cooking whole meals) - manually

Before cooking meals with the manual menu cooking function, switch off steam reduction (see “Settings – Steam reduction”).

When cooking a menu, you can combine different foods with different cooking durations, e.g. fish fillet with rice and broccoli.

The food is placed in the steam oven compartment at different times so that each item is ready at the same time.

Shelf level

Place foods that produce a lot of liquid (e.g. fish) or have a distinctive colour (e.g. beetroot) directly above universal tray. This avoids any transfer of flavour or colour to other food and prevents liquid dripping onto food below it.

Temperature

Whole meals should be cooked at a temperature of 100 °C as this is the temperature required to cook the majority of foods.

Do not cook a whole meal at the lowest temperature when different temperatures are required for different types of food, e.g. 85 °C for seabream and 100 °C for potatoes.

If the recommended cooking temperature for the food is 85 °C for example, try cooking it at 100 °C and testing the result. Some delicate types of fish with a soft structure, e.g. sole and plaice will become very firm when cooked at 100 °C.

Duration

If you are increasing the recommended temperature, shorten the cooking duration by approx. $\frac{1}{3}$.

Example

Food cooking durations

(see cooking tables in “Steam cooking”)

Parboiled rice	24 minutes
Rosefish fillet	6 minutes
Broccoli	4 minutes

Calculation of set cooking durations:

24 minutes minus

6 minutes = 18 minutes (1st cooking duration: rice)

6 minutes minus 4 minutes = 2 minutes (2nd cooking duration: rosefish fillet)

Remaining time = 4 minutes (3rd cooking duration: broccoli)

Cooking duration	24 min. – rice		
		6 min. – fish fillet	
			4 min. – broccoli
Settings	18 min.	2 min.	4 min.

Steam cooking

Cooking a whole menu

- Place the rice in the oven compartment first.
- Set the 1st cooking duration: 18 minutes.
- After the 18 minutes, place the fish into the appliance.
- Set the 2nd cooking duration: 2 minutes.
- After the 2 minutes, place the broccoli into the appliance.
- Set the 3rd cooking duration: 4 minutes.

Sous-vide (vacuum) cooking

With this gentle cooking method, food is cooked slowly and at a low, constant temperature in vacuum packaging.

With vacuum cooking, no moisture evaporates during cooking and all nutrients and flavours are retained.

The cooking result has an intensive taste and food is cooked evenly.

Use only fresh food which is in a good condition.

Ensure hygienic conditions and that food has not been out of the refrigerator too long, e.g. during transportation.

Use only heat-stable, boiling-resistant vacuum sealing bags.

Do not cook food in the sales packaging, such as vacuum-packed frozen food as it is possible that the packaging used is not suitable for vacuum cooking.

Do not use the vacuum sealing bag more than once.

Vacuum-seal the food in a chamber system vacuum sealer only.

Sous-vide (vacuum) cooking

Important usage notes

For best cooking results, follow the instructions below:

- Use herbs and spices more sparingly than with conventional cooking methods because the impact on the taste of the food will be stronger. You can also cook the food unseasoned and add seasoning after cooking.
 - The cooking duration is reduced when salt, sugar and liquids are added.
 - The food becomes firmer if acidic ingredients such as lemon or vinegar are added.
 - Do not use alcohol or garlic as this can produce unpleasant flavours.
 - Only use vacuum sealing bags that match the size of the food. If the vacuum sealing bag is too big, too much air can remain inside.
 - If you want to cook several items of food in one vacuum sealing bag, put them side by side in the bag.
 - If you want to cook food in several vacuum sealing bags at once, put the bags side by side on the rack.
 - The cooking durations depend on the thickness of the food.
 - Keep the door closed during the cooking process. Opening the door will prolong the cooking process and can change the cooking result.
- Temperatures and cooking durations from sous-vide recipes cannot always be emulated exactly. Alter the settings to achieve the degree of cooking you want.
 - With high temperatures and/or long cooking durations, the appliance may run low on water. Check the display from time to time.

Sous-vide (vacuum) cooking

Tips

- In order to reduce cooking times, you can vacuum-seal food items 1–2 days before the cooking programme. Store the vacuum-sealed food in the refrigerator at no more than 5 °C. In order to preserve quality and flavour, the food should be cooked no later than 2 days afterwards.
- Freeze liquids such as marinades before vacuum-sealing to prevent them from escaping from the bag.
- Fold the edges of the vacuum sealing bag outwards for filling. This will give you clean, perfect seams.
- If you do not want to eat the food straight after cooking, put it in iced water immediately and allow it to cool down completely. After this, store the food at temperatures no greater than 5 °C.
This way, you can retain the food's quality and flavour while keeping it fresh for longer.
Exception: Poultry must be eaten straight after the cooking programme.
- After cooking, cut the vacuum sealing bag on all sides for easier access to the food.
- Briefly fry meat and firm types of fish (such as salmon) before serving for a roasted aroma.
- Use the stock or marinade of vegetables, fish or meat to make a sauce.
- Serve the food on pre-warmed plates.

Using the Sous-vide function

- Rinse the food with cold water and dry it.
- Place the food in a vacuum sealing bag and add spices or liquid if desired.
- Vacuum-seal the food in a chamber system vacuum sealer.
- For the best cooking results, place the rack on shelf level 2.
- Place the vacuum-sealed food on the rack (next to each other if there are several bags).
- Select Oven functions .
- Select Sous-vide .
- Change the recommended temperature if necessary.
- Confirm with OK.
- Set further settings as necessary (see "Operation").

Sous-vide (vacuum) cooking

Possible reasons for unsatisfactory results

The bag has opened:

- The seal was not clean or strong enough and has opened.
- The bag was damaged by a sharp bone.

The food has an unpleasant or strange taste:

- Incorrect storage of the food; the food was kept out of the refrigerator for too long.
- The food was contaminated with bacteria before it was vacuum sealed.
- Too much of ingredients such as spices was added.
- The bag or seal was not in perfect order.
- The vacuum was insufficient.
- The food was not eaten or chilled immediately after cooking.

Sous-vide (vacuum) cooking

The cooking durations given in the tables are guidelines only. We recommend selecting the shorter duration initially. You can cook for longer if necessary. The cooking duration only begins when the set temperature is reached.

Food	Added in advance		🌡️ [°C]	⌚ [min]
	Sugar	Salt		
Fish				
Atlantic cod fillet, 2.5 cm thick		x	54	35
Salmon fillet, 2–3 cm thick		x	52	30
Monkfish fillet		x	62	18
Pikeperch fillet, 2 cm thick		x	55	30
Vegetables				
Cauliflower florets, medium to large		x	85	40
Hokkaido pumpkin, sliced		x	85	15
Kohlrabi, sliced		x	85	30
Asparagus, white, whole	x	x	85	22–27
Sweet potato, sliced		x	85	18
Fruit				
Pineapple, sliced	x		85	75
Apples, sliced	x		80	20
Baby bananas, whole			62	10
Peaches, halved	x		62	25–30
Rhubarb chunks			75	13
Plums, halved	x		70	10–12
Other				
Beans, white, soaked in a ratio of 1:2 (beans to liquid)		x	90	240
Prawns, peeled and deveined		x	56	19–21
Hen's egg, whole			65–66	60
Scallops, removed from shell			52	25
Shallots, whole	x	x	85	45–60

🌡️ Temperature ⌚ Duration

Sous-vide (vacuum) cooking

Food	Added in advance		🌡️ [°C]		🕒 [min]
	Sugar	Salt	Medium*	Done*	
Meat					
Duck breast, whole		x	66	72	35
Saddle of lamb			58	62	50
Beef fillet steak, 4 cm thick			56	61	120
Beef rump steak, 2.5 cm thick			56	–	120
Pork tenderloin, whole		x	63	67	60

🌡️ Temperature 🕒 Duration

* Degree of cooking

The “well done” cooking degree uses a higher core temperature than “medium”, but results are not the same as being well-done in the traditional sense.

Reheating

Only reheat brassicas, such as kohlrabi and cauliflower, in combination with a sauce. Without sauce, an unpleasant cabbage-like taste and grey-brown colour may develop.

Food with a short cooking duration or which continues cooking during reheating, such as fish, is not suitable for reheating.

Preparation

Place the cooked food into ice water for approx. 1 hour directly after cooking. The rapid cooling prevents the food from continuing to cook, which helps retain the optimum cooked condition. Then store the food in the refrigerator at a maximum temperature of 5 °C.

Please note that the quality of the food decreases the longer it is stored.

We recommend that you do not store the food in the refrigerator for longer than 5 days before reheating.

Settings

Oven functions | Sous-vide 

Temperature: see table

Duration: see table

Sous-vide (vacuum) cooking

Reheating with the Sous-vide function

The durations specified in the table are guidelines only. You can increase the duration if necessary. The cooking duration only begins when the set temperature is reached.

Food	🌡️ [°C]		🕒 ² [min]
	Medium ¹	Done ¹	
Meat			
Saddle of lamb	58	62	30
Beef fillet steak, 4 cm thick	56	61	30
Beef rump steak, 2.5 cm thick	56	–	30
Pork tenderloin, whole	63	67	30
Vegetables			
Cauliflower florets, medium to large ³	85		15
Kohlrabi, sliced ³	85		10
Fruit			
Pineapple, sliced	85		10
Other			
Beans, white, soaked in a ratio of 1:2 (beans to liquid)	90		10
Shallots, whole	85		10

🌡️ Temperature, 🕒 Time

1 Degree of cooking

The “well done” cooking degree uses a higher core temperature than “medium”, but results are not the same as being well-done in the traditional sense.

2 Durations apply to vacuum-sealed food with an initial temperature of approx. 5 °C (refrigerator temperature).

3 Reheat only in sauce.

Reheat

To reheat food which was cooked using the sous-vide method, use the Sous-vide  function (see “Sous-vide – Reheating”).

The combination steam oven is very effective at reheating food gently, without drying it out or cooking it further. The food will reheat evenly and does not need to be stirred during the reheating process.

You can reheat individual dishes or plated meals which have been prepared previously (e.g. meat, vegetables and potatoes).

Suitable containers

Small quantities can be reheated on a plate, larger quantities should be placed in a cooking container.

Time

10–12 minutes are usually sufficient for one plate of food. More than one plate will need a little longer.

If you are reheating several plated meals one after the other, the reheating time can be reduced by around 5 minutes for the second and subsequent plates as the oven compartment will still be hot.

Moisture

The more moist the food, the less moisture needs to be added.

Tips

- Do not reheat large items, such as a joint of roast meat, whole. Divide it into portions and reheat these as plated meals.
- Compact items, such as stuffed peppers or roulades, should be cut in half.
- Reheat sauces separately. Exceptions are dishes such as goulash, which is cooked in sauce.
- Please note that breaded items, such as schnitzel, will not retain their crispness when they are reheated.

Food does not need to be covered before it is reheated.

Settings

Special applications  | Reheat or

Oven functions  | Combi mode  | Combi Fan plus 

Temperature: see chart

Moisture: see chart

Duration: see chart

Special applications

The durations specified in the chart are guidelines only. We recommend selecting the shorter duration initially. You can make the duration longer if necessary.

Food	🔥 [°C]	💧 [%]	⌚* [min]
Vegetables			
Carrots Cauliflower Kohlrabi Beans	120	70	8–10
Side dishes			
Pasta Rice Potatoes, cut in half lengthways	120	70	8–10
Dumplings Mashed potato	140	70	18–20
Meat and poultry			
Sliced meat, 1.5 cm thick Roulades, sliced Goulash Lamb stew Meatballs Chicken escalopes Turkey escalopes, sliced	140	70	11–13
Fish			
Fish fillet Fish roulade, halved	140	70	10–12
Plated meals			
Spaghetti, in tomato sauce Pork roast, potatoes and vegetables Stuffed peppers (cut in half), rice Chicken fricassee, rice Vegetable soup Creamed soup Clear broth Stew	120	70	10–12

🔥 Temperature, 💧 Moisture, ⌚ Duration

* These times apply to food heated on a plate.

Defrost

It is much quicker to defrost food in the combination steam oven than at room temperature.

 Risk of infection from bacteria. Bacteria such as salmonella can cause life-threatening food poisoning.

It is particularly important to observe food hygiene rules when defrosting fish and meat, and in particular when defrosting poultry.

Do not use the liquid produced during defrosting.

Process the food as required as soon as it has been defrosted.

Temperature

60 °C is the best temperature for defrosting.

Exception: 50 °C for minced meat and game

Before and after defrosting

Remove any packaging before defrosting.

Exceptions: Leave bread, biscuits and cakes in their packaging as otherwise they will absorb moisture and become soft.

Allow food to stand at room temperature for a few minutes after defrosting. The standing time is necessary to allow the even distribution of heat from the outside to the inside.

Cooking containers

Use a perforated container with the universal tray underneath when defrosting food which will drip, such as poultry. This way food will not be lying in defrosted liquid.

Food which does not drip can be defrosted in a solid container.

Tips

- Fish, for instance, does not need to be fully defrosted before cooking. Defrost so that the surface is sufficiently thawed to take herbs and seasoning. Depending on the thickness of the fish, 2–5 minutes is generally enough.
- When defrosting food which has frozen together, e.g. berries and meat portions, separate them half-way through the defrosting time.
- Do not refreeze food once it has thawed.
- Defrost frozen pre-cooked meals according to the instructions on the packaging.

Settings

Special applications  | Defrost or

Oven functions  | Steam cooking 

Temperature: see chart

Defrosting time: see chart

Standing time: see chart

Special applications

The durations specified in the table are guidelines only. We recommend selecting the shorter defrosting time initially. You can increase the defrosting time longer if necessary.

Frozen food	Quantity	🌡️ [°C]	🕒 [min]	⌚ [min]
Dairy products				
Sliced cheese	125 g	60	15	10
Quark	250 g	60	20–25	10–15
Cream	250 g	60	20–25	10–15
Soft cheese	100 g	60	15	10–15
Fruit				
Apple sauce	250 g	60	20–25	10–15
Apple chunks	250 g	60	20–25	10–15
Apricots	500 g	60	25–28	15–20
Strawberries	300 g	60	8–10	10–12
Raspberries/currants	300 g	60	8	10–12
Cherries	150 g	60	15	10–15
Peaches	500 g	60	25–28	15–20
Plums	250 g	60	20–25	10–15
Gooseberries	250 g	60	20–22	10–15
Vegetables				
Frozen in a block	300 g	60	20–25	10–15
Fish				
Fish fillets	400 g	60	15	10–15
Trout	500 g	60	15–18	10–15
Lobster	300 g	60	25–30	10–15
Small shrimps	300 g	60	4–6	5
Ready meals				
Meat, vegetables, side dishes/ stew/soup	480 g	60	20–25	10–15
Meat				
Roast meat, sliced	125–150 g each	60	8–10	15–20

Special applications

Frozen food	Quantity	🌡️ [°C]	🕒 [min]	⌚ [min]
Minced meat	250 g	50	15–20	10–15
	500 g	50	20–30	10–15
Goulash	500 g	60	30–40	10–15
	1000 g	60	50–60	10–15
Liver	250 g	60	20–25	10–15
Saddle of hare	500 g	50	30–40	10–15
Saddle of venison	1000 g	50	40–50	10–15
Cutlets/chops/sausages	800 g	60	25–35	15–20
Poultry				
Chicken	1000 g	60	40	15–20
Chicken thighs	150 g	60	20–25	10–15
Chicken escalopes	500 g	60	25–30	10–15
Turkey legs	500 g	60	40–45	10–15
Baked goods				
Puff pastries/yeast-dough pastry	–	60	10–12	10–15
Creamed mixture cakes/biscuits	400 g	60	15	10–15
Bread/rolls				
Bread rolls	–	60	30	2
Rye bread, sliced	250 g	60	40	15
Wholegrain bread, sliced	250 g	60	65	15
White bread, sliced	150 g	60	30	20

🌡️ Temperature 🕒 Defrosting time ⌚ Standing time

Special applications

Mix & Match

The Mix & Match special application is available to help with simple and uncomplicated preparation of plated meals. With this application, you can re-heat food that has already been cooked (convenience food) or assemble a portioned-out meal using fresh food and cook it on a plate.

During cooking, you have the choice between a crispy, browned result or gently cooked food with a succulent surface without additional browning.

Only use food that is completely hygienic. If you have any concerns, dispose of the food.

Tip: We recommend using the Miele app for the Mix & Match special application. With the Miele app, you can inter-actively assemble your meal using a wide range of ingredients and then transfer the programme settings to your combination steam oven.

To use this function, you need to connect your combination steam oven to the WiFi network. Find out how to do this in “Before using for the first time” – “Miele@home”.

If you choose not to use the Miele app, follow the instructions below and assemble your meal using the cooking charts.

Containers

Use:

- a flat plate or a small ovenproof dish
- a deep bowl or a cup for food that requires liquid to be added

Baked goods, pizza, flammkuchen, etc. can be placed directly on the rack (with baking parchment if necessary).

The plastic containers for ready meals are not sufficiently heat-resistant.

Transfer ready meals into suitable cooking containers.

Tips for reheating plated meals

- For fried or gratin dishes, use *Crispy reheating* and for baked or boiled dishes, use *Gentle reheating*.
- Using *Crispy reheating* ensures that only food that was crispy before reheating stays crispy.
- The food should not exceed a height of 2–2.5 cm. Transfer taller food into flat containers (e.g. stew) or slice it into smaller pieces (e.g. roulades, bakes).
- Only reheat pasta mixed into a sauce.
- Droplets of water may have accumulated underneath the crockery. Dry the droplets of water before serving.

Tips for cooking plated meals

- You can easily make a sauce from the meat and fish stock: add 1 tsp of cornflour to the raw meat or fish before cooking. Stir the sauce with a fork until smooth before serving. You can also use 1 tsp of mashed potato powder (instant) or a pinch of guar gum instead of cornflour.
- If cooking durations for different foods are not the same, you can compensate for this by changing the size of the food: if the cooking duration is shorter, make the pieces larger (e.g. large cauliflower florets). If the cooking duration is longer, make the pieces smaller (e.g. diced potatoes).
- You can also compensate for differing cooking durations with layering: place food with a short cooking duration under a food with a long cooking duration or put them together as a small bake.
- To prevent the food from drying out, prepare your dish with a sauce or marinade. You can also use cheese or bacon.

Assembling a plated meal using various components

For a good cooking result, you must put together the individual components of the dish – such as meat, side dishes and vegetables – so that a common setting can be selected for browning. This setting must be suitable for all elements of the meal, or at least conditionally suitable.

We recommend using the following procedure:

- Select a main ingredient based on the cooking charts, e.g. steak.
- Select other ingredients which have the corresponding settings for browning, e.g. green beans and rice.

Special applications

Notes on the cooking charts

As well as information on portion sizes or the way the food needs to be processed prior to cooking, the cooking charts also provide tips on preparation.

The degree of browning is represented in the display by a bar with seven segments. Basically, the more segments that are filled, the longer the cooking duration.

You can use the icons to determine which setting is appropriate to brown the food:

Symbol	Meaning
—	Unsuitable
□	Conditionally suitable
■	Suitable

Using the Mix & Match special application

Food does not need to be covered while it is being cooked.

- Prepare the food as required.
- Select Special applications | Mix & Match.
- If you are preparing food that is already **cooked**, select Gentle reheating or Crispy reheating.
- If you are preparing food that is **fresh** or just partially cooked, select Gentle cooking or Crispy cooking.
- Change the setting for browning if necessary.
- Confirm with *OK*.
- Place the food on the rack on shelf level 3.
- Confirm with *OK*.

You can start the cooking programme immediately or delay the start.

- If by the end of a cooking programme, the plated meal is not cooked enough for your taste, select Cont. cooking.

Reheating food with the “Crispy reheating” special application

Food	Browning segment bar setting
Apple strudel, 4 cm thick, baked	___ _ □ ■ □ _
Baked camembert, 75 g, baked	___ _ □ ■ □ _
Baguette, baked	_ □ ■ □ _ _ _
Puff pastry canapés, baked	_ □ ■ □ □ _ _
Tofu patty ¹ , cooked	_ □ □ ■ □ _ _
Bread roll, pre-baked or baked, stored	_ _ □ ■ □ _ _
Cheeseburger, cooked	_ _ □ ■ _ _ _
Chili con carne ¹ , 2 cm thick, cooked	_ _ _ □ ■ □ _
Ciabatta rolls, pre-baked or baked, stored	_ _ _ ■ □ _ _
Tarte flambée, baked	_ □ ■ □ _ _ _
Meat strips ¹ , pre-cooked or cooked	□ □ ■ □ □ _ _
Meat patty ¹ (pork), 60 g, cooked	_ _ _ □ ■ □ _
Spring roll, 100 g, cooked	_ _ _ _ □ ■ □
Kaiserschmarrn pancake ¹ , frozen, thawed	_ □ □ ■ □ □ _
Potatoes, mainly waxy, sliced, cooked	_ _ □ ■ □ _ _
Potato pockets, baked	_ _ □ □ ■ □ _
Lasagne ¹ , 3 cm thick, cooked	_ _ _ ■ □ _ _
Pasta bake ¹ , 4.5 cm thick, cooked	_ _ _ □ ■ _ _
Pancakes ¹	_ _ □ ■ □ _ _
Pizza, baked	□ □ ■ □ □ □ _
Quiche, 3.5 cm thick, baked	_ _ _ _ □ ■ □
Potato pancakes ¹ , cooked	_ _ _ ■ □ _ _
Hash browns, cooked	_ _ _ □ ■ □ _
Escalopes, cooked	_ _ □ ■ □ □ _

¹ is not crispy, only needs to be sufficiently heated (> 65 °C).

Special applications

Cooking food with the “Crispy cooking” special application

Food	Cooking tips	Browning segment bar setting
Meat¹		
Bratwurst, 100 g, boiled	Slashed	___ _ _ _ _ <input type="checkbox"/> <input checked="" type="checkbox"/> <input type="checkbox"/>
Meat patty, 60 g, 2.5 cm thick	Ground meat, seasoned	___ _ _ _ _ <input type="checkbox"/> <input checked="" type="checkbox"/> <input type="checkbox"/>
Chicken breast, 3 cm thick, raw	On its own, seasoned	_ <input type="checkbox"/> <input type="checkbox"/> <input checked="" type="checkbox"/> _ _ _ _ _
Chicken drumstick, raw	Marinated	___ _ _ <input type="checkbox"/> <input type="checkbox"/> <input type="checkbox"/> <input checked="" type="checkbox"/>
Veal tenderloin, 2.5 cm thick, raw	Marinated, with sauce	<input checked="" type="checkbox"/> _ _ _ _ _
Smoked pork cutlet, 3.5 cm thick, raw	–	___ _ <input type="checkbox"/> <input checked="" type="checkbox"/> <input type="checkbox"/> <input type="checkbox"/> <input type="checkbox"/>
Lamb chop, 2 cm thick, raw	Marinated	<input type="checkbox"/> <input checked="" type="checkbox"/> <input type="checkbox"/> <input type="checkbox"/> _ _ _ _ _
Steak, 3 cm thick, raw	Marinated	_ <input type="checkbox"/> <input checked="" type="checkbox"/> <input type="checkbox"/> _ _ _ _ _
Pork tenderloin, 4 cm thick, raw	Wrapped in bacon, with salt and pepper	<input type="checkbox"/> <input type="checkbox"/> <input checked="" type="checkbox"/> <input type="checkbox"/> _ _ _ _ _
Pork chop, 1.5 cm thick, raw	Coated in breadcrumbs, drizzled with a little oil	___ _ _ _ _ <input checked="" type="checkbox"/>
Fish¹		
Halibut cutlet, 3 cm thick, raw	Marinated	<input type="checkbox"/> <input checked="" type="checkbox"/> _ _ _ _ _
Cod filet, 3.5 cm thick, raw	Marinated	<input checked="" type="checkbox"/> <input type="checkbox"/> <input type="checkbox"/> _ _ _ _ _
Salmon filet, 3 cm thick, raw	Seasoned	<input type="checkbox"/> <input type="checkbox"/> <input checked="" type="checkbox"/> <input type="checkbox"/> <input type="checkbox"/> _ _ _
Pollock filet, 3 cm thick, raw	Seasoned, topping: spinach, feta	<input checked="" type="checkbox"/> <input type="checkbox"/> _ _ _ _ _
Tuna filet, 3 cm thick, raw	Marinated	___ _ <input type="checkbox"/> _ _ _ _ _
Catfish kebab, 50 g chunks, raw	Marinated, with bacon	___ <input type="checkbox"/> <input type="checkbox"/> <input type="checkbox"/> <input checked="" type="checkbox"/> _ _ _
Vegetables		
Aubergine, 2 cm thick, raw	Marinated	___ _ _ <input checked="" type="checkbox"/> <input type="checkbox"/> _ _ _
Cauliflower, large florets, raw	Salt, pepper, buttered breadcrumbs	<input type="checkbox"/> <input type="checkbox"/> <input checked="" type="checkbox"/> <input type="checkbox"/> _ _ _ _ _
Broccoli, large florets, raw	Cheese sauce	<input type="checkbox"/> <input checked="" type="checkbox"/> <input type="checkbox"/> _ _ _ _ _
Bacon-wrapped string beans, raw	Wrapped in bacon, seasoned	___ _ <input checked="" type="checkbox"/> <input type="checkbox"/> _ _ _ _ _
Potatoes, waxy, 3 mm slices, raw	Butter, salt or cheese	___ _ _ <input type="checkbox"/> <input type="checkbox"/> <input type="checkbox"/> <input checked="" type="checkbox"/>
Kohlrabi, 2 cm slices, raw	Salt, pepper, nutmeg	<input type="checkbox"/> <input type="checkbox"/> <input checked="" type="checkbox"/> <input type="checkbox"/> _ _ _ _ _
Pumpkin, 2 cm chunks, raw	Salt, pepper, pumpkin seed oil	<input checked="" type="checkbox"/> <input type="checkbox"/> <input type="checkbox"/> _ _ _ _ _
Corn on the cob, raw	Salt, butter	_ <input type="checkbox"/> <input type="checkbox"/> <input checked="" type="checkbox"/> <input type="checkbox"/> _ _ _

Special applications

Food	Cooking tips	Browning segment bar setting
Carrots, 2 cm slices, raw	Salt, pepper, butter	□ □ ■ □ _ _ _
Bell pepper, large chunks, raw	Marinated	□ □ □ ■ □ _ _
Courgette, 2 cm slices, raw	Marinated	_ □ □ ■ □ □ _
Pasta & rice		
Fresh pasta, tortellini, pre-cooked	–	□ _ _ _ _ _ _
Lasagne, 3 cm thick, pre-cooked	–	■ □ _ _ _ _ _
Pasta bake, 2 cm thick, pre-cooked	–	■ _ _ _ _ _ _
Rice, brown rice, cooking duration 8 minutes, uncooked	Salt, 1 : 2 (rice : liquid)	_ □ ■ □ _ _ _
Rice, parboiled rice, cooking duration 8–12 minutes, uncooked	Salt, 1 : 1.5 (rice : liquid)	_ _ □ ■ □ _ _
Rice, pre-cooked	–	□ □ ■ □ _ _ _
Pizza etc.		
Baked camembert, 25 g, frozen	Thawed	■ □ □ □ _ _ _
Baguettes, frozen or pre-baked	Thawed	□ ■ _ _ _ _ _
Bread rolls, frozen or pre-baked	Thawed	□ ■ □ _ _ _ _
Cheeseburger, pre-cooked	–	■ _ _ _ _ _ _
Dates in bacon, raw	–	_ □ □ ■ □ _ _
Tarte flambée, uncooked	Top with chilled pastry	_ _ □ ■ □ _ _
Spring roll, 100 g, frozen	Thawed	_ □ ■ □ _ _ _
Grilled cheese, 90 g, pre-cooked	–	_ _ _ _ □ ■ □
Potato pockets, frozen	Thawed	■ □ _ _ _ _ _
Gnocchi, pre-cooked	Butter, salt, cheese	■ _ _ _ _ _ _
Potato pancakes, uncooked	Drizzled with a little oil	_ _ □ ■ □ _ _
Schupfnudeln (potato dumplings), pre-cooked	–	□ □ ■ □ □ □ _
Tofu patty, 80 g, cooked	–	■ _ _ _ _ _ _
Pizza, baked	–	□ ■ □ _ _ _ _
Hash browns, frozen	Thawed	■ □ _ _ _ _ _
Onion tart, 2.5 cm thick	Pre-baked	_ _ _ _ _ ■ □

Special applications

Food	Cooking tips	Browning segment bar setting
Desserts		
Kaiserschmarrn pancake, cooked	–	_ □ □ ■ □ □ _

¹ Add 1 tsp cornflour to raw meat/fish.

Food suitable for the “Gentle cooking” special application

Food	Cooking tip
Meat¹	
Sausage (pork), 100 g, cooked	–
Beef filet skewer, 50 g chunks, raw	Marinated, with bacon
Pork skewer, 50 g chunks, raw	Marinated, with bell pepper and onion
Chicken breast, 3 cm thick, raw	On its own, seasoned
Veal tenderloin, 2.5 cm thick, raw	Marinated, in sauce
Smoked pork, 3.5 cm thick, raw	–
Fish¹	
Trout, whole, 350 g, raw	Seasoned, filling: butter, herbs
Halibut cutlet, 3 cm thick, raw	Marinated
Cod filet, 3.5 cm thick, raw	Marinated
Salmon filet, 3 cm thick, raw	Seasoned
Pollock fillet, 180 g	Topping: spinach and crème fraîche
Tuna filet, 3 cm thick, raw	Marinated
Catfish kebabs, 50 g chunks	Marinated, with bacon
Vegetables	
Cauliflower, large florets, raw	Seasoned
Broccoli, large florets, raw	Seasoned, with/without cheese sauce
Potatoes, waxy, quartered/in wedges, raw	Salt
Kohlrabi, 2 cm slices, raw	Salt, pepper, nutmeg
Pumpkin, 1.5 cm chunks, raw	Salt, pepper, pumpkin seed oil
Corn on the cob, raw	Salt, butter
Carrots, 2 cm slices, raw	Salt, pepper, butter
Bell pepper, large chunks, raw	Marinated

Special applications

Food	Cooking tip
Brussels sprouts, whole, raw	Salt, pepper, nutmeg
Asparagus, spears, whole, raw	Salt, butter
Sweet potato, 1.5 cm chunks/wedges, raw	Salt
Courgette, 2 cm slices, raw	Marinated
Pasta & rice	
Fresh pasta, tortellini, pre-cooked	Sauce
Macaroni, short, uncooked	Salt, 1 : 3 (pasta : water)
Rice, basmati rice, cooking duration 10 minutes, uncooked	Salt, 1 : 2.5 (rice : liquid)
Rice, brown rice, cooking duration 8 minutes, uncooked	Salt, 1 : 2 (rice : liquid)
Rice, parboiled rice, cooking duration 8–12 minutes, uncooked	Salt, 1 : 2 (rice : liquid)
Rice, short-grain rice, cooked	–
Vermicelli, uncooked	Covered with stock
Pizza etc.	
Gnocchi, pre-cooked	Salt, butter
Mashed potato, cooked	–
Schupfnudeln (potato dumplings), pre-cooked	Salt, butter

¹ Add 1 tsp cornflour to raw meat/fish.

Special applications

Menu cooking – automatic

When cooking a menu automatically, you can combine up to 3 different foods in a single menu, e.g. fish fillet with rice and vegetables.

With menu cooking, the food is placed in the steam oven compartment at different times so that each item is ready at the same time.

You can select items of food in any order, because the combination steam oven sorts them according to cooking duration and indicates when each item has to be placed in the oven.

The Finish at and Start at functions are not available in menu cooking.

Using the Menu cooking special application

- Select Special applications  | Menu cooking.
- Select the food you want.

Depending on the type of food selected, you will be asked about the size, weight and degree of cooking.

- Select the values required and then confirm with *OK*.
- Select Add food.
- Select the next food you want and proceed as described for the first type of food.
- Repeat for the third type of food if necessary.

After confirming Start Menu cooking, you will be prompted to place the food with the longest cooking duration into the oven compartment.

- When using perforated containers to cook foods that produce a lot of liquid or have a distinctive colour, be sure to place them over the universal tray. This avoids any transfer of flavour or colour to other food and prevents liquid dripping onto food below it.

At the end of the heating-up phase, the combination steam oven will indicate when the next item of food has to be placed inside. Once this time has been reached, a buzzer will sound.

This process is repeated if there is a third food item.

You can still cook food types not listed together. Please refer to “Menu cooking – manual” in “Steam cooking” for more information.

Bottling

Only use unblemished, fresh produce which is in good condition for bottling.

Glass jars

Use clean glass jars and accessories and check them for any defects. Glass jars with twist off lids or glass lids with a rubber seal are suitable.

Make sure that all the jars are the same size so that bottling is carried out evenly.

After you have filled the jars with the bottled produce, clean the glass rims with a clean cloth and hot water and then seal the jars.

Fruit

Sort fruit carefully, rinse it briefly but thoroughly and allow it to drain. Take great care when cleaning soft fruit as it is very delicate and squashes easily.

Remove any peel, stalks, cores or stones. Cut up large fruit. For example, cut apples into slices.

If you are bottling fruit with stones (e.g. plums, apricots) without removing the stones, pierce the fruit several times with a fork or wooden skewer as otherwise it will burst.

Vegetables

Rinse, clean and cut up vegetables.

Vegetables should be blanched before bottling to help them retain their colour (see “Special applications” – “Blanching”).

Fill volume

Fill the glass jars with produce up to a maximum of 3 cm below the rim. Do not pack it down as this will damage the cell walls of the produce. Tap the jar gently onto a cloth to help distribute the contents evenly. Fill the jars with liquid. The produce must be completely covered.

Use a sugar solution for fruit and a salt or vinegar solution for vegetables.

Special applications

Tips

- Make use of residual heat by leaving the jars in the oven for 30 minutes after it has switched off.
- Then cover the jars with a cloth and allow to cool for approx. 24 hours.

Bottling food

- Place a perforated container or the rack in level 1.
- Place the jars in the perforated container or on the rack. The jars must not touch each other.

Settings

Special applications | Bottling

or

Oven functions | Steam cooking

Temperature: see table

Bottling duration: see table

Special applications

The durations specified in the chart are guidelines only.

Food to be bottled	🌡️ [°C]	🕒* [min]
Berries		
Currants	80	50
Gooseberries	80	55
Cranberries	80	55
Fruit with stones		
Cherries	85	55
Mirabelle plums	85	55
Plums	85	55
Peaches	85	55
Greengages	85	55
Fruit with pips		
Apples	90	50
Apple sauce	90	65
Quinces	90	65
Vegetables		
Beans	100	120
Broad beans	100	120
Gherkins	90	55
Beetroot	100	60

🌡️ Temperature 🕒 Duration

* Bottling times apply to 1.0 l jars. If using 0.5 l jars, reduce the duration by 15 minutes. If using 0.25 l jars, reduce the duration by 20 minutes.

Special applications

Bottling cakes

Creamed, sponge and yeast dough mixtures are all suitable for bottling. Cakes will keep for approx. 6 months.

Cakes **made with fresh fruit** are **not suitable for long term storage**, and must be consumed within 2 days of being made.





Only use sterilised jars and accessories. The jars must be narrower at the bottom than at the top (mason jars). 0.25 l jars are the best for this purpose.

Jars must have a glass lid with a rubber ring and metal spring clamp to seal them.

Make sure that all the jars are the same size so that the preserving process is carried out evenly.

- Grease the inside of the jars with butter up to 1 cm below the rim.
- Sprinkle fine breadcrumbs inside the jars.
- Fill the jars $\frac{1}{2}$ to $\frac{2}{3}$ full with mixture (depending on recipe). Make sure the rim stays clean.
- Place the rack in shelf level 2.
- Place the **open** jars (all the same size) on the rack. The jars must not touch each other.
- Close the jars **immediately** after bottling by clamping the glass lid down securely. Do not let the cakes cool down. If the mixture has risen above the rim, it can be pushed back down into the jar with the glass lid.

The durations specified in the chart are guidelines only. We recommend selecting the shorter duration initially. You can extend the duration if necessary.

Type of mixture	Operating mode	Stage	🌡️ [°C]	ΔΔ [%]	🕒 [min]
Batter		–	160	–	35–45
Sponge		–	160	–	50–55
Yeast dough		1	30	100	10
		2	160	30	30–35

🌡️ Temperature, ΔΔ Moisture, 🕒 Duration

 Conventional heat,  Combination cooking + Conventional heat

Drying

Only use the Drying special application or the Combi Fan plus  operating mode to dry food so that moisture can be dissipated.

Bananas, pineapple and chanterelles are not suitable for drying.

- Cut the food for drying into equally sized pieces.
- Line the rack with baking parchment and distribute the food for drying evenly in a single layer if possible.
- Allow the fruit or vegetables to cool down after drying.
- Store dried food in sealed glass jars or tins.
To prevent mould from forming and the food from decomposing, make sure that no moisture gets into the storage container.

Settings

Special applications  | Drying

Temperature: see chart

Drying time: see chart

or

Oven functions  | Combi mode  |



Combi Fan plus 

Temperature: see chart

Moisture: 0 %

Drying time: see chart

The drying times specified in the chart are guidelines only. We recommend selecting the shorter drying time initially. You can make the duration longer if necessary.

Food for drying	 [°C]	 [h]
Apple, rings	70	6–8
Apricots, halved, stones removed	60–70	10–12
Pears, sliced	70	7–9
Herbs	40	1.5–2.5
Mushrooms*	50	5–7
Tomatoes, sliced	70	7–9
Citrus fruit, sliced	70	8–9
Plums, stones removed	60–70	10–12

 Temperature,  Drying time (hours)

* Porcini, shiitake, morels, wood ear, bay bolete are suitable for drying. The mushrooms are sufficiently dried when they are “cracker dry”.

Special applications

Sabbath programme

The Sabbath programme and Yom-Tov special applications help to support religious observance.

The combination steam oven heats up to the temperature you have set and maintains this temperature for a maximum of 24 hours (Sabbath programme) or 76 hours (Yom-Tov).

- Turn off furniture front detection.
- Select Special applications .
- Select Sabbath programme.
- Select the special application you want.

You will not be able to start the special application if you have set a minute minder or alarm.

- Set the temperature.
- Select Start.

The name of the special application and the set temperature appear on the display.

The oven heating switches on around 30 seconds after you have closed the door.

The oven interior lighting remains switched on during the entire cooking process.

Sabbath programme or Yom-Tov and the set temperature appear permanently on the display.

The time of day does not appear. The proximity sensor does not respond, and neither do any of the sensor controls (except for the On/Off  sensor control).

Do not open the door appears.

After around 1 hour, this information switches off from time to time. You can open the door when it is **not** shown.

- Place the food in the oven compartment.

The Sabbath programme special application ends after 24 hours. The display does not change.

In both special applications, the combination steam oven switches off automatically after 76 hours.

- If you want to end the special application prematurely, switch off the combination steam oven using the On/Off  sensor control.

Once a special application has started, it cannot be changed or saved under User programmes.

Extracting juice with steam

This combination steam oven is ideal for extracting juice from soft and firm fruit.

It is best to use overripe fruit, as the riper the fruit, the greater the quantity of juice produced. Very ripe fruit will also produce a more intense flavour.

Preparation

Sort and clean the fruit. Cut out any blemishes.

Remove the stalks from grapes and morello cherries as these are bitter. Berries do not need to have their stalks removed.

Cut larger fruit such as apples into chunks of approximately 2 cm in size. The harder the fruit, the smaller the pieces should be.

Tips

- Try experimenting with mild and tart fruit.
- Adding sugar will increase the quantity of juice produced and improve the flavour. Sprinkle the fruit with sugar and leave to absorb for a few hours before juicing. For 1 kg of sweet fruit add 50–100 g of sugar, and for 1 kg of tart fruit add 100–150 g of sugar.
- If you wish to bottle the juice rather than consume it straight away, pour it whilst hot into hot, sterilised bottles, and then seal immediately with sterilised tops.

Extracting juice from fruit

- Put the prepared fruit into a perforated cooking container.
- Place a solid cooking container or the universal tray underneath in order to collect the juice.

Settings

Oven functions | Steam cooking 

Temperature: 100 °C

Duration: 40–70 minutes

Special applications

Blanching

Blanch vegetables before freezing them. Blanching helps maintain the quality of the produce when it is frozen.

Blanching vegetables also helps them retain their original colour.

- Put the prepared vegetables into a perforated cooking container.
- Once blanched, plunge the vegetables into ice cold water to cool them down quickly. Drain them well.

Settings

Special applications  | Blanching

or

Oven functions | Steam cooking 

Temperature: 100 °C

Blanching time: 1 minute

Disinfect items

By the end of this programme, crockery and baby bottles disinfected in the combination steam oven are as free from germs as they would have been had they been boiled. Check beforehand that all parts are declared by the manufacturer to be heat resistant to 100 °C and also that they can withstand hot steam.

Dismantle baby bottles into their individual parts. Do not reassemble the bottles until they are completely dry. This is the only way to prevent them from getting reinfected.

- Place the individual items on the rack or in a perforated container (on their sides or with the opening facing downwards) ensuring that they do not touch one another to allow hot steam to reach them from all sides.

Settings

Special applications  | Disinfect items

Duration: 1 minute to 10 hours

or

Oven functions | Steam cooking 

Temperature: 100 °C

Duration: 15 minutes

Heat crockery

If the crockery is pre-heated, the food does not cool down as quickly.

Use heat-resistant crockery.

- Place the rack on shelf level 2 and place the crockery to be warmed on it. Depending on the size of the crockery, you can also place the rack on the floor of the oven compartment with the rack surface facing up and the crockery on top. If necessary, you can also remove the side runners.
- Select Special applications .
- Select Heat crockery.
- Alter the recommended temperature if necessary and then set the time.

 Risk of injury caused by hot surfaces.

The combination steam oven gets hot during operation. You could burn yourself on the heater elements, oven compartment, side runners or accessories. Droplets of water may have accumulated underneath the crockery.

Use oven gloves when removing the crockery from the oven.

Keeping warm

You can keep food warm in the oven compartment for up to 2 hours.

In order to maintain the quality of food, select the shortest possible time.

- Select Special applications .
- Select Keeping warm.
- Place the food to be kept warm in the oven compartment and confirm with *OK*.
- Alter the recommended temperature if necessary and then set the time.



Special applications

Prove dough

- Prepare the dough according to the recipe.
- Place the dough in an uncovered bowl in a perforated container or on the inserted rack.
Depending on the size of the bowl, you can also place the rack on the floor of the oven compartment with the rack surface facing up and place the bowl on top. If necessary, you can also remove the side runners.

Settings

Special applications  | Prove dough
or

Oven functions  | Combi mode  |
Combi Fan plus 

Temperature: 30 °C

Moisture: 100 %

Duration: as per recipe instructions

Heating damp flannels

- Moisten the flannels and then roll them up.
- Place them beside one another in a perforated cooking container.

Settings

Automatic programmes  | Special | Heat
damp flannels

or

Oven functions  | Steam cooking 

Temperature: 70 °C

Cooking duration: 2 minutes

Dissolve gelatine

- Soften **gelatine leaves** by leaving them in a bowl of cold water for 5 minutes. The gelatine leaves have to be fully covered with water. Remove the gelatine leaves from the bowl and squeeze them out. Empty the bowl. Place the squeezed gelatine leaves back in the bowl.
- Place **gelatine powder** in a bowl and add water according to the instructions on the packaging.
- Cover the bowl and place in a perforated container.

Settings

Automatic programmes  | Special | Dis-
solve gelatine

or

Oven functions  | Steam cooking 

Temperature: 90 °C

Cooking duration: 1 minute

Decrystallise honey

- Loosen the lid and place the jar of honey in a perforated cooking container.
- Stir the honey once during the cooking duration.

When liquefying (decrystallising) honey at a temperature of 60 °C, the main aim is to achieve a spreadable consistency again.

Settings

Automatic programmes Auto | Special | Decrystallise honey

or

Oven functions | Steam cooking

Temperature: 60 °C

Duration: 90 minutes (irrespective of the size of jar or the amount of honey in the jar)

Select the following settings to ensure that the honey retains its nutrients and aroma:

Oven functions | Combi mode | Combi Conventional

Temperature: 37 °C

Moisture: 100 %

Time: until the honey has a homogeneous appearance

Melt chocolate

You can use the combination steam oven for melting any type of chocolate. When using a cake glaze, place it in a perforated cooking container, leaving it in its packaging.

- Break the chocolate into small pieces.
- Place larger quantities in a solid cooking container and smaller quantities in a cup or a bowl.
- Cover the container or the dish with a lid or with foil that is resistant to temperatures up to 100 °C and to hot steam.
- Stir large quantities once halfway through cooking.

Settings

Automatic programmes Auto | Special | Melt chocolate

or

Oven functions | Steam cooking

Temperature: 65 °C

Cooking duration: 20 minutes

Special applications

Cook bacon

The bacon does not brown.

- Place the bacon (diced or rashers) in a solid cooking container.
- Cover the container with foil that is temperature-resistant up to 100 °C and resistant to steam.

Settings

Automatic programmes Auto | Special |
Render fat

or

Oven functions | Steam cooking

Temperature: 100 °C

Cooking duration: 4 minutes

Sweat onions

Sweating means cooking the onions in their own juices, with the addition of a little fat if necessary.

- Cut the onions up into small pieces and place them in a solid cooking container with a little butter.
- Cover the container with foil that is temperature-resistant up to 100 °C and resistant to steam.

Settings

Automatic programmes Auto | Special |
Sweat onions

or

Oven functions | Steam cooking

Temperature: 100 °C

Cooking duration: 4 minutes

Apple storage

You can treat homegrown apples in the steam oven to increase the length of time for which you can store them. Once treated, the apples will keep for 5 to 6 months when stored in a dry, cool and well-ventilated place. This method is only suitable for apples and not for other types of fruit.

Settings

Automatic programmes Auto | Fruit | Apples | Whole

or

Oven functions | Steam cooking 
Temperature: 50 °C
Preserving time: 5 minutes

Making eierstich

- Mix 6 eggs with 375 ml milk (do not beat into a foam).
- Season the egg and milk mixture and pour into a solid cooking container greased with a little butter.

Settings

Oven functions | Steam cooking 
Temperature: 100 °C
Cooking duration: 4 minutes

Special applications

Fruit preserve

Only use unblemished, fresh produce which is in good condition.

Glass jars

Only use sterilised jars with twist-off lids up to a maximum capacity of 250 ml.

After pouring in the fruit, clean the rim of the jar with a clean cloth and hot water.

Preparation

Sort fruit carefully, rinse it briefly but thoroughly and allow it to drain. Take great care when cleaning soft fruit as it is very delicate and squashes easily. Remove any stalks, cores or stones.

Purée the fruit as otherwise the preserve will not set. Add jam sugar to the fruit (according to packet instructions) and stir well.

For sweet fruit and berries you should also add some citric acid.

Making fruit preserve

- Fill jars maximum 2/3 full.
- Place the jars without their lids on in a perforated container or on the rack.
- Once the total time required has finished, leave the jars to stand for 1–2 minutes.
- Then seal the jars with a lid and leave them to cool.

Settings

Oven functions | Combi mode

Combi Fan plus

Temperature: 150 °C

Moisture: 0 %

Duration: 35–45 minutes

Skimming vegetables and fruit

- Cut a cross in the top of tomatoes, nectarines etc. This will allow the skin to be removed more easily.
- Place the fruit/vegetables in a perforated cooking container if using steam cooking and on the universal tray if using the grill.
- To blanch almonds, it is important to plunge them into cold water as soon as they are taken out of the oven. Otherwise the skin cannot be removed.

Settings

Oven functions | Full grill

Level: 3

Duration: see chart

Food	🕒 [min]
Peppers	10
Tomatoes	7

🕒 Duration

Settings

Oven functions | Steam cooking

Temperature: 100 °C

Duration: see table

Food	🕒 [min]
Apricots	1
Almonds	1
Nectarines	1
Peppers	4
Peaches	1
Tomatoes	1

🕒 Duration

Special applications

Make yoghurt

To make yoghurt, you will need either fresh live yoghurt or yoghurt culture, obtainable from health food shops.

Use natural yoghurt with live culture and without additives. Heat-treated yoghurt is not suitable.

The yoghurt must be fresh (short storage time).

You can use either unchilled long-life milk or fresh milk.

Long-life milk can be used as it is – no further preparation is required. Fresh milk must first be heated to 90 °C (do not boil it) and then cooled down to 35 °C. Fresh milk will give a better set than long-life milk.

The yoghurt and milk should have the same percentage fat.

Do not move or shake the jars whilst the yoghurt is thickening.

Immediately after preparation, leave the yoghurt to cool in the fridge.

How well home-prepared yoghurt sets will depend on the consistency, fat content and the cultures used in the starter yoghurt. Not all yoghurts are suitable for use as starter yoghurt.

Tip: When using yoghurt enzyme, yoghurt can be made from a milk / cream mixture. Mix $\frac{3}{4}$ litre milk with $\frac{1}{4}$ litre cream.

- Mix 100 g yoghurt with 1 l milk or make up the mixture with yoghurt enzyme, following the instructions on the packaging.
- Pour the mixture into jars and seal the jars.
- Place the sealed jars in a perforated container, making sure they do not touch one another.
- Immediately after the yoghurt has been made, place the jars in the refrigerator, taking care not to shake them unnecessarily.

Settings

Automatic programmes Auto | Special |
Make yoghurt

or

Oven functions | Steam cooking
Temperature: 40 °C
Duration: 5:00 hours

Possible reasons for unsatisfactory results

Yoghurt has not set:

Incorrect storage of starter yoghurt, too much time out of the refrigerator, e.g. in transportation, damaged packaging, milk not sufficiently heated.

Liquid has separated:

The jars were moved, yoghurt was not cooled down quickly enough.

Yoghurt is gritty:

Milk was overheated or in poor condition, milk and starter yoghurt not evenly stirred.

The wide range of automatic programmes enables you to achieve excellent results with ease.

Categories

The **Auto** automatic programmes are sorted into categories to provide a better overview. Simply select the appropriate programme for the type of food you are cooking and follow the instructions in the display.

Using automatic programmes

- Select Automatic programmes **Auto**.

A list will appear in the display.

- Select the desired food category.

The automatic programmes available for the food category selected will then appear.

- Select the desired automatic programme.
- Follow the instructions in the display.

Some automatic programmes and special applications will prompt you to use the food probe. Read the information under “Roasting – Food probe”.

The core temperature cannot be changed for the automatic programmes.

Tip: Use **i** Info to display information such as how to place or turn the food depending on the cooking programme.

Usage notes

- After cooking, allow the oven compartment to cool down to room temperature again before starting an automatic programme.
- The weights specified in the automatic programmes refer to the weight per piece. For example, you can cook just one piece of salmon weighing 250 g or ten pieces of salmon, each weighing 250 g, at the same time.
- The degree of cooking and browning are represented by a bar with seven segments. You can set how well you want the food cooked or how brown you want it to be by touching the relevant segment.
- Some roasting programmes also offer the **Roast with moisture** option. With this option, meat is cooked at a low temperature over a long cooking duration for tender and succulent results. The additional moisture helps to achieve the best cooking and browning result: the meat is very succulent and tender. The cut is cooked evenly and has a thin brown outer layer that forms during the roasting programme. It is therefore not necessary to sear the meat beforehand. In contrast to the **Roast** option, there is no need to use the food probe in this case and you can set a start or end time to suit your menu planning.
- Please refer to the cookbook for information on suitable bakeware.
- In the **Rice** category, you can select **General** in addition to the long-grain and short-grain rice programmes. Use this automatic programme if you

Automatic programmes

want to prepare long-grain or short-grain rice varieties that are not available as a specific automatic programme.

- For some automatic programmes, the start or end time can be delayed using **Start at** or **Finish at**.
- The individual cooking stages of the automatic programme are listed under the **Display cooking stages** menu option. The **Display actions** menu option is also available for some automatic programmes. You can call up required actions, e.g. placing food in the oven or adding ingredients, via this menu option. During the cooking process, you can view the actions via **i** **Info**.
- When you place food into the hot oven compartment, be careful when opening the door. Hot steam may escape. Step back and wait until the steam has dissipated. Avoid contact with hot steam, and do not touch the hot oven compartment walls. Danger of burning and scalding.
- If by the end of an automatic programme the food is not cooked enough for your taste, select **Cont. cooking** or **Continue baking**.
- Automatic programmes can also be saved as **User programmes**.

There is a full text search function which can also be used to search for parts of words.

From the main menu:

- Select **Automatic programmes** **Auto**.

The category list will appear in the display.

- Select **Search**.
- Use the keyboard to type in the search text, e.g. "Bread".

The number of hits will be shown in the footer.

If no match is found, or if there are more than 40 matches, the **hits** field is deactivated and you will need to change the search text.

- Select **XX hits**.

The categories and automatic programmes available will then appear.

- Select the desired automatic programme, or the category and then the automatic programme.

The automatic programme will start.

- Follow the instructions in the display.

Search

(Depending on language)

Under **Automatic programmes**, you can search by the name of the categories and the automatic programmes.

Under MyMiele , you can save frequently used applications.

It is particularly useful with automatic programmes as you do not need to work through every menu level in order to start your programme.



Tip: You can also set menu options that you have entered in MyMiele as your start screen (see “Settings – Start screen”).

Adding entries

You can add up to 20 entries.

- Select MyMiele .
- Select Add entry.

You can select sub-menus from the following:

- Oven functions 
- Automatic programmes 
- Special applications 
- User programmes 
- Maintenance 

- Confirm with OK.

The selected sub-option with its symbol appears in the list.

- Proceed as described for further entries. Only sub-options which have not yet been added are available for selection.

Deleting entries

- Select MyMiele .
- Touch the entry you want to delete and keep your finger on it until the context menu appears.
- Select Delete.

The entry will then be removed from the list.

Moving entries

- Select MyMiele .
- Touch the entry you want to move and keep your finger on it until the context menu appears.
- Select Move.

An orange border appears around the entry.

- Move the entry.

The entry appears in the desired position.

User programmes

You can create and save up to 20 of your own programmes.

- You can combine up to 9 cooking stages to accurately programme your favourite or most frequently used recipes. In each cooking stage, you can select settings such as the function, temperature and cooking duration.
- You can enter the name of the programme for your recipe.

When you call up and start your programme again, it will run automatically.

There are different ways of creating a user programme:

- At the end of an automatic programme or special application, save it as a user programme.
- Save a cooking programme after running it with a set cooking duration.

Then enter a programme name.

Creating user programmes

- Select **User programmes** .

- Select **Create prog.**

You can now specify the settings for the first cooking stage.

Follow the instructions in the display:

- Select and confirm the settings you want.

If you select the **Pre-heat** function, use **Add** to add another cooking stage where you set a cooking duration. Only then can you save or start the programme.

All settings for the first cooking stage have now been set.

You can add more cooking stages, for example, if you want to add another cooking function to follow on from the first.

- If additional cooking stages are required, select **Add** and proceed as for the first cooking stage.

If you want to check the settings or to change them at a later stage, touch the cooking stage in question.

- When you have finished setting all the cooking stages, select **Save**.

- Enter the programme name using the keyboard.

You can add a line break for longer programme names using the **↵** symbol.

- Once you have entered the programme name, select **Save**.

A message will appear in the display confirming that the programme name has been saved.

- Confirm with *OK*.

You can start the saved programme immediately, delay the start or change the cooking stages.

Starting user programmes

- Place the food in the oven compartment.
- Select User programmes .
- Select the programme you want to use.

Depending on the programme settings, the following menu options appear in the display:

- Start now
The programme will start immediately. The oven heating will switch on immediately.
- Finish at
Specify the time you want the programme to stop. The oven heating will switch off automatically at the time you have set.
- Start at
Specify the time when you want the programme to start. The oven heating will switch on automatically at the time you have set.
- Display cooking stages
A summary of your settings will appear on the display.
- Display actions
The required actions, e.g. placing the food in the oven, will appear in the display.

- Select the menu option you want.

The programme selected will begin straight away or at the time set.

Use  Info to display information such as how to place or turn the food depending on the cooking programme.

- At the end of the programme, select *Close*.

User programmes

Changing cooking stages

Cooking stages in automatic programmes that have been saved under a different name cannot be changed.

- Select User programmes .
- Touch the programme you want to change and keep your finger on it until the context menu appears.
- Select Change.
- Select the cooking stage that you want to change or Add to add another cooking stage.
- Select and confirm the desired settings.
- If you want to start the modified programme without changing it, select Start.
- Select Save when you have changed all the settings.

A message will appear in the display confirming that the programme name has been saved.

- Confirm with *OK*.

The saved programme has been changed and you can start it immediately or delay the start.

Renaming User programmes

- Select User programmes .
- Touch the programme you want to change and keep your finger on it until the context menu appears.
- Select Rename.
- Change the programme name using the keyboard.

You can add a line break for longer programme names using the  symbol.

- Once you have changed the programme name, select Save.

A message will appear in the display confirming that the programme name has been saved.

- Confirm with *OK*.

The programme has now been renamed.

Deleting User programmes

- Select User programmes .
- Touch the programme you want to delete and keep your finger on it until the context menu appears.
- Select Delete.
- Confirm the query with Yes.

The programme will be deleted.

Go to Settings | Factory default | User programmes to delete all User programmes at the same time.

Moving User programmes

- Select User programmes .
- Touch the programme you want to move and keep your finger on it until the context menu appears.
- Select Move.

An orange border appears around the entry.

- Move the programme.

The programme appears in the desired position.

Baking

Handling food carefully will help protect your health.

Cakes, pizzas and french fries should be cooked until golden, not dark brown.

Baking tips

- Set a cooking duration. When baking, the oven should not be set to start a long time off. Otherwise the cake mixture or dough will dry out, and the raising agents will lose their effectiveness.
- Generally speaking, you can use racks, universal trays and any type of baking tray made of heat-resistant material.
- Always place baking tins on the rack.
- Always cook frozen goods such as cakes, pizza or baguettes on the rack.

Very high temperatures can cause the universal tray to distort to such an extent that the tray cannot be taken out of the oven compartment.

- Small items of frozen food such as oven chips or potato croquettes can be cooked on the universal tray. Turn these frozen food items several times during cooking.
- Bake on a maximum of 2 levels at the same time.

Using baking parchment

Miele accessories, e.g. the universal tray, are treated with PerfectClean (see "Cleaning and care"). Surfaces treated with PerfectClean generally do not need to be greased or covered with baking parchment.

■ Use baking parchment when cooking:

- lye mixtures because anything prepared using a lye containing sodium hydroxide can damage the PerfectClean surface
- mixtures with a high egg white content, such as sponge, meringue and macaroons, as these can easily stick
- puff pastry or strudel dough
- frozen food on the rack
- small items of frozen food such as oven chips or potato croquettes on the universal tray

Tips on baking

- Dark tins are best for baking. Avoid using bright, thin-walled tins as they give an uneven or poor browning result. In certain unfavourable conditions, the food will not cook properly.
- Position rectangular tins with the longer side across the width of the oven compartment for optimum heat distribution and even baking results.
- When cooking frozen food such as chips, croquettes, cakes, pizza and baguettes, select the medium temperature quoted on the manufacturer's packaging.
- If a range is specified for the cooking duration, check whether the food is cooked after the shortest duration. Stick a wooden skewer into the food. If it comes out clean without any batter/dough on it, the food is done.



Notes on the functions

You can find an overview of all the functions with their recommended values in "Main and sub-menus".

Combi mode

This operating mode uses a combination of oven heat and moisture. The addition of steam prevents the surface of the food from drying out. Bread, bread rolls and puff pastry have a shiny and crispy crust.

You can choose between different types of heating:

- Combi Fan plus 
- Combi Conventional 
- Combi Grill 

We recommend baking bread and bread rolls in several cooking stages: the shine is created during the 1st cooking stage thanks to the injection of steam (maximum moisture, low temperature). Browning takes place in the next cooking stage with high moisture and a high temperature. It is then dried with reduced moisture and a medium to high temperature.

Tip: Recipes and comprehensive cooking charts with information on operating modes, temperatures, moisture and cooking durations can be found in the Miele combination steam oven cookbook.

Baking

Automatic programmes

Follow the instructions on the display.

Fan plus

Use this function if you are baking on multiple shelves at the same time.

You can use any type of baking tray made of heat-resistant material.

Because the fan distributes the heat around the oven compartment straight away, it allows you to use a lower temperature than you would with the Conventional heat  function.

Conventional heat

Use this function for baking traditional recipes. If using an older recipe or cookbook, set the oven temperature 10 °C lower than the recommended one. This will not change the cooking duration.

Only bake on one level. If you are making a tray bake, use level 3. If you are making a cake in a baking tin, select level 2.

Intensive bake

This function is suitable for baking cakes with moist toppings, pizza, quiche, etc.

Place the food in shelf level 1.

Bottom heat

Use this function towards the end of cooking to brown the base of the food.

Top heat

Use this function towards the end of cooking to brown the top of the food being cooked.

This function is suitable for gratins and for browning bakes.

Cake plus

Use this function for baking batter and frozen lye mixtures.

Eco Fan heat

Use this operating mode for cooking small amounts of food, e.g. frozen pizzas or biscuits, while saving energy.

Tips for roasting

- Frozen meat must be defrosted before it is cooked as otherwise it would dry out. Always defrost meat before roasting.
- Remove skin and sinew before roasting.
- Marinate and season the meat to taste.
- If you are cooking several pieces of meat together, use pieces that are similar in size.
- Use the universal tray with the rack placed on top of it. The oven compartment stays cleaner and you can then use the meat juices collected to make a gravy or sauce.

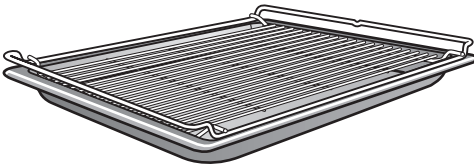

- Allow a standing time of approx. 10 minutes before carving meat. This resting time ensures the meat juices are distributed evenly.



Notes on the functions

You can find an overview of all the functions with their recommended values in “Main and sub-menus”.

Combi mode

This operating mode uses a combination of oven heat and moisture. The addition of steam prevents the surface of the food from drying out. The results are particularly tender and succulent meat with a well-browned outside. Use the Combi mode  operating mode for cooking meat, fish and poultry dishes.

You can choose between different types of heating:

- Combi Fan plus 
- Combi Conventional 
- Combi Grill 

We recommend cooking meat slowly and gently in several cooking stages: at a high temperature during the 1st cooking stage to brown the surface. The 2nd cooking stage requires increased moisture and a reduced temperature. The meat cooks evenly and the muscle protein is broken down, making the meat particularly tender.

Tip: Recipes and comprehensive cooking charts with information on operating modes, temperatures, moisture and cooking durations can be found in the Miele combination steam oven cookbook.

Roasting

Automatic programmes

Follow the instructions on the display.

Fan plus

This function is suitable for roasting meat and poultry that needs to be well browned.

Because the fan distributes the heat around the oven compartment straight away, it allows you to use a lower temperature than you would with the Conventional heat  function.

Conventional heat

Use this function for baking traditional recipes. If using an older recipe or cookbook, set the oven temperature 10 °C lower than the recommended one. This will not change the cooking duration.

Use the Bottom heat  function towards the end of the cooking duration to brown the base of the food.

Do not use the Intensive bake  function for roasting as the juices will become too dark.

Food probe

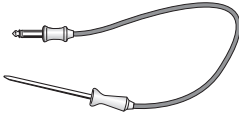

The food probe allows the temperature to be monitored precisely during a cooking programme.

Principle of operation

The metal tip of the food probe must be fully inserted into the centre of the meat. There is a temperature sensor in the metal tip which measures the core temperature of the food during cooking.

The core temperature set will depend on how well cooked you want your meat to be and on the type of meat. It can be set between 30 and 99 °C.

The cooking duration will depend on a number of different factors. The higher the temperature in the oven compartment and the moisture (where applicable) and the thinner the meat, the quicker the set core temperature will be reached.

 Damage caused by high temperatures.









Temperatures higher than 100 °C will damage the temperature sensor in the food probe beyond repair.

If you are not using the food probe, remove it from the oven compartment when cooking.

When to use the food probe

Some automatic programmes and special applications will prompt you to use the food probe.

You can also use the food probe with User programmes and with the following functions:

- Fan plus 
- Conventional heat 
- Combi Fan plus 
- Combi Conventional 
- Steam cooking 
- Intensive bake 
- Fan grill 
- Cake plus 

Roasting

Important usage notes

- You can place the meat in a pot or on the rack.
- The metal tip of the food probe must be fully inserted into the centre of the food so that the temperature sensor reaches more or less to the core.
- When cooking poultry, insert the metal tip into the thickest part of the breast. Press the breast with your index finger and thumb to find the thickest part.
- The metal tip must not touch any bone or be inserted in areas with a lot of fat. Heavily marbled areas and bones can cause cooking to end prematurely.
- If the meat is very heavily marbled with fat, select the highest core temperature given in the cooking charts.
- When using aluminium foil or roasting bags, insert the food probe through the foil/bag into the centre of the food. You can also place meat inside the bag or foil with the food probe already inserted. Follow the roasting bag manufacturer's instructions.

Using the food probe

- Insert the metal tip of the food probe completely into the centre of the food all the way to the handle.

If you are cooking several pieces of meat at the same time, insert the food probe into the largest piece of meat.

- Place the food in the oven compartment.
- Remove the rubber stopper from the connection socket for the food probe.

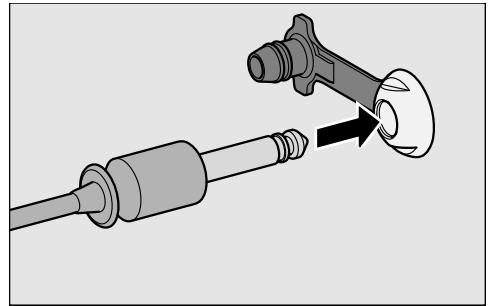

- Insert the plug of the food probe into the socket until you feel it engage.
- Close the door.
- Select the operating mode or automatic programme.
- Set the temperature and the core temperature if necessary.

The core temperatures cannot be changed for the automatic programmes.

Follow the instructions on the display.

The cooking process is brought to an end as soon as the core temperature is reached.

 Risk of injury caused by hot surfaces.

The food probe can get hot. You could burn yourself on the food probe.

Wear oven gloves when removing the food probe from its socket.

- Once the oven compartment has cooled down, reinsert the rubber stopper into the connection socket for the food probe.

Delaying the start of a cooking programme with food probe

You can set the cooking programme to start at a later time.

- Select Start at.

The finish time can be calculated approximately because the duration of a cooking programme is about the same, whether or not the food probe is used.

You cannot set Duration and Finish at because the total cooking duration is determined by when the set core temperature is reached.

Chart with core temperatures

Meat	 [°C]
Roast veal	75–80
Gammon joint	63
Leg of lamb pink medium well done	64 76 82
Saddle of lamb pink medium well done	53 65 80
Saddle of venison pink medium well done	60 72 81
Roast beef	80
Fillet of beef/ sirloin joint pink medium well done	45 54 75
Roast ham/pork	85
Pork fillet pink medium well done	60 66 75
Game/leg cut	85

 Core temperature

Grilling

 Risk of injury caused by hot surfaces.

If you open the appliance door during grilling, the control elements will get very hot.

Keep the door closed during the grilling programme.

Grilling tips

- Pre-heating is not necessary when grilling. Place the food in the cold oven compartment.
- Use the universal tray with the rack placed on top of it.



- When grilling fish, place the fish on a piece of baking paper cut to size.
- Grill thick food, e.g. half a chicken, on level 2 or 3 and thin food, e.g. steaks, on level 4.
- Turn the food $\frac{2}{3}$ of the way through the cooking duration. Exception: fish does not need to be turned.

Tips for grilling

- Marinate lean meat or brush it with oil. Do not use other types of fat as they can burn and cause smoke.
- Pierce sausages before grilling.
- It is best to grill food of a similar thickness at the same time so that the grilling time for each item does not vary too greatly.
- To **test the food**, press down on the meat with a spoon. This lets you determine how well the meat has been cooked.
 - **Rare/pink**
If the meat gives easily to the pressure of the spoon, it will still be red on the inside.
 - **Medium**
If there is some resistance, the inside will be pink.
 - **Well done**
If there is very little resistance, it is cooked through.
- To grill thicker pieces of food more gradually after an initial high temperature, continue grilling at a lower temperature setting or use a lower shelf level to allow the food to cook through to the centre.

Notes on the functions

You can find an overview of all the functions with their recommended values in “Main and sub-menus”.

The plastic on the food probe can melt at very high temperatures.

Do not use the food probe when using the grill functions.

Do not store the food probe in the oven compartment when it is not being used.

Combi Grill

This function is suitable for grilling food that should be brown on the outside, but not dry, e.g. corn on the cob.

Full grill

Use this function to grill flat thin cuts in large quantities and for browning large baked dishes.

Economy grill

Use this function to grill flat thin cuts in smaller quantities and for browning small baked dishes.

Fan grill

This function is suitable for grilling thicker food, such as poultry, rolled meat.

Cleaning and care

Important information on cleaning and care

 Risk of injury caused by hot surfaces.

The combination steam oven gets hot during operation. You could burn yourself on the heater elements, oven compartment, side runners or accessories.

Allow the heater elements, oven compartment, side runners and the accessories to cool before manual cleaning.

 Risk of injury due to electric shock.

The steam from a steam cleaning appliance could reach live electrical components and cause a short circuit.

Do not use a steam cleaner to clean the combination steam oven.

All surfaces can discolour or alter if unsuitable cleaning agents are used. The front of the combination steam oven is particularly susceptible to damage from oven cleaners or descaling agents.

All surfaces are susceptible to scratching. Scratches on glass can in some circumstances lead to breakage.

Remove all cleaning agent residues immediately.

Stubborn soiling could damage the combination steam oven in certain circumstances.

Once the oven has cooled, clean the oven compartment, the inside of the door and the door seal. Waiting too long can make cleaning unnecessarily difficult and in some cases impossible.

Do not use commercial cleaning agents. Only use agents designed for domestic use.

Do not use cleaning agents or washing-up liquids containing aliphatic hydrocarbons as these could cause the seals to swell.

- The combination steam oven and accessories should be cleaned and dried after each use.
- Leave the appliance door open until the oven compartment is completely dry.

If you mainly steam cook and do not use the **HydroClean** care programme, you should run a cooking process at a temperature above 225 °C at least once a year to remove moisture, including from inaccessible parts of the combination steam oven.

If the combination steam oven is not going to be used for a longer period of time, it should be thoroughly cleaned and dried beforehand to prevent the build-up of odours, etc. Leave the door open afterwards.

Unsuitable cleaning agents

To avoid damaging the surfaces of your appliance, do not use:

- Cleaning agents containing soda, ammonia, acids or chlorides
- Cleaning agents containing descaling agents
- Abrasive cleaning agents (e.g. powder cleaners, scouring milk, scouring pads)
- Solvent-based cleaning agents
- Dishwasher cleaning agents
- Glass cleaning agents
- Cleaning agents for ceramic glass hobs
- Hard, abrasive brushes or sponges (e.g. pot scourers, brushes or sponges which have been previously used with abrasive cleaning agents)
- Eraser stain remover blocks
- Sharp metal scrapers
- Steel wool
- Stainless steel spiral pads
- Spot cleaning with mechanical cleaning agents
- Oven cleaners and sprays

Cleaning the front

- Clean the appliance front with a clean, soft sponge and a solution of warm water and washing-up liquid.
- After cleaning, wipe the surfaces dry using a soft cloth.

Tip: A clean, damp microfibre cloth without cleaning agent can also be used.

Cleaning and care

PerfectClean

The surfaces of the universal tray, the combi rack and the HFC 71 FlexiClip runners have been **treated with PerfectClean**. This finish has an iridescent appearance. PerfectClean surfaces have very good anti-stick properties and are easy to clean.

However, it is important to clean the surfaces each time the oven is used. The non-stick properties will deteriorate if soiling is not removed from PerfectClean surfaces after each use. If used frequently without being cleaned, cleaning may become very difficult.

Spilt fruit juices may cause discolouration to the surfaces that cannot be removed. However, this does not affect the properties of the PerfectClean finish.

Always remove all cleaning agent residues to protect the non-stick properties.

To protect the non-stick effect of PerfectClean surfaces, please avoid:

- Abrasive cleaning agents (e.g. powder cleaners, scouring milk, scouring pads)
- Cleaning agents for ceramic glass hobs
- Ceramic and stainless steel cleaner
- Steel wool
- Abrasive sponges, e.g. pot scourers or sponges which have been previously used with abrasive cleaning agents
- Oven spray
- Spot cleaning with mechanical cleaning agents

Do **not** clean PerfectClean accessories in the dishwasher.

Oven compartment

It is normal for the oven compartment to have a yellow tinge after prolonged use. This will not affect functionality in any way.

Ensure that no cleaning agent gets into the openings on the oven compartment rear panel.

To make cleaning the oven compartment easy, you can remove the oven door, dismantle the side runners and lower the top heat/grill element.

Cleaning after a programme using steam

■ Remove:

- Condensate using a sponge or absorbent cloth
- Light, greasy soiling with a clean sponge and a solution of washing-up liquid and hot water

■ After cleaning, wipe the surface with clean water to remove any cleaning agent residues.

■ Then dry the oven compartment and the inside of the door with a cloth.

Tip: You can then leave the oven compartment to dry automatically using the Drying care programme (see “Care”).

Cleaning after a roasting, grilling or baking programme

Clean the oven compartment thoroughly after roasting, grilling and baking as otherwise soiling may burn on and become impossible to remove.

- Clean the oven compartment and inside of the door with a clean dishwashing sponge, hot water and a little washing-up liquid. You can use the rough side of a dishwashing sponge to clean the oven compartment if necessary.
- After cleaning, wipe the surface with clean water to remove any cleaning agent residues.
- Then dry the oven compartment and the inside of the door with a cloth.

Tip: Soaking the soiling for a few minutes with a solution of washing-up liquid and hot water can make cleaning easier. Alternatively run the Maintenance  | Soak programme.

For heavy, stubborn soiling, we recommend cleaning the oven compartment using the HydroClean care programme (see “Care”).

Cleaning and care

Cleaning the floor filter

- The filter in the floor of the oven should be cleaned and dried after every use.
- Vinegar can be used to remove discolouration and limescale deposits from the filter in the floor of the oven. Rinse thoroughly with clean water afterwards.

Cleaning the door seal

The door seal may become brittle and tear on account of contact with grease residues.

Clean the door seal after every roasting, grilling or baking programme.

- Clean the door seal using a clean, damp microfibre cloth without any cleaning agent. You can also use a clean absorbent cloth and warm water with a little washing-up liquid.
- After cleaning, dry the seal with a soft cloth.
- Check that the door seal is fitted correctly.
If necessary, press the door seal in all the way round the door to make sure it is installed snugly and evenly.

If the door seal is damaged, e.g. cracked, the seal needs to be replaced. Contact the Miele Customer Service Department.

Do not cook with steam or clean using the HydroClean care programme until you replace the seal.

Cleaning the water container and condensate container

The water container and condensate container are suitable for cleaning in a dishwasher.

- Remove the water container and condensate container after every use. Remove the water container and condensate container by pushing them upwards slightly.
- Empty the water container and condensate container.

Water can drip into the water container and condensate container compartment when removing the containers.

- Dry the compartment if necessary.
- Rinse the water container and condensate container by hand or in the dishwasher.
- Then dry the water container and condensate container with a cloth to prevent limescale.

Accessories

Cleaning the universal tray and combi rack

The surfaces of the universal tray and the combi rack have been treated with PerfectClean. Please see “PerfectClean” in the “Cleaning and care” chapter for instructions on cleaning.

- Remove:
 - light soiling with a clean sponge and a solution of washing-up liquid and hot water
 - stubborn soiling with a clean dish-washing sponge, hot water and a little washing-up liquid. If necessary, you can also use the rough side of the sponge.
- After cleaning, wipe the surface with clean water to remove any cleaning agent residues.
- Then dry the surfaces using a cloth.

Cleaning cooking containers

The cooking containers are suitable for cleaning in a dishwasher.

- Wash and dry the cooking containers after each use.
- Any bluish discolouration on cooking containers can be removed with vinegar. Rinse with clean water.

Cleaning the food probe

Do not put the food probe into water or clean it in the dishwasher as this will damage it. Clean the food probe with a damp cloth only.

Cleaning and care

Cleaning the side runners

The side runners can be removed together with the FlexiClip runners (if inserted).

If you want to remove the FlexiClip runners separately beforehand, please follow the instructions in “Fitting and removing FlexiClip runners” in the “Guide to the appliance” chapter.

The surfaces of the HFC 71 FlexiClip runners have been treated with PerfectClean.

Please see “PerfectClean” in “Cleaning and care” for instructions on cleaning.

⚠ Risk of injury caused by hot surfaces.

The combination steam oven gets hot during operation. You could burn yourself on the heater elements, oven compartment or accessories. Allow the heater elements, oven compartment and accessories to cool before removing the side runners.

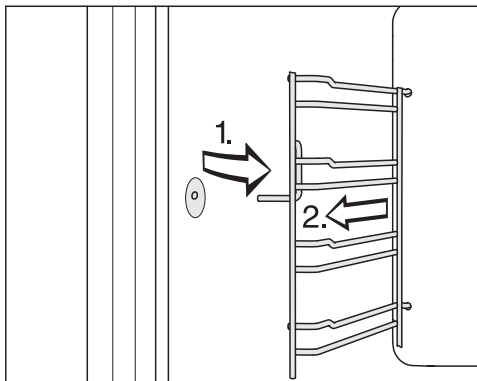

■ Pull the side runners out of holder (1.) from the front and remove them (2.).

■ Remove:

- Light soiling with a clean sponge and a solution of washing-up liquid and hot water

- Stubborn soiling with a clean dish-washing sponge, hot water and a little washing-up liquid. If necessary, you can also use the rough side of the sponge.

■ After cleaning, wipe the surface with clean water to remove any cleaning agent residues.

■ Then dry the side runners with a cloth.

Reassemble by following these instructions in reverse order.

■ Refit the side runners carefully.

If the side runners are not correctly inserted, there is no anti-tip protection. The temperature sensor could also be damaged when cooking containers are placed in the steam oven.

Lowering the top heat/grill element

If the ceiling of the oven is badly soiled, the top heat/grill element can be lowered by approx. 5 cm to make cleaning easier.

 Risk of injury caused by hot surfaces.

The combination steam oven gets hot during operation. You could burn yourself on the heater elements, oven compartment, side runners or accessories.

Allow the heater element, oven compartment, side runners and the accessories to cool before cleaning.

Be careful not to damage the top heat/grill element.

Never use force when pulling down the top heat/grill element.

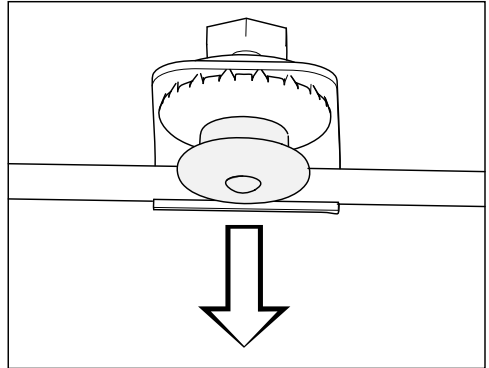

- Carefully pull down the pressure cap. The top heat/grill element then lowers automatically.
- Clean the ceiling of the oven with an absorbent cloth or a dishwashing sponge (see “Cleaning and care” – “Oven compartment”).
- After cleaning the top heat/grill element, push the pressure cap back up. Make sure the pressure cap engages correctly.

Cleaning and care

Maintenance

The Finish at and Start at functions are not available with maintenance programmes.

Soak

Stubborn soiling can be soaked using this maintenance programme.

- Allow the oven compartment to cool down.
- Take all accessories out of the oven compartment.
- Remove coarse soiling with a cloth.
- Select Maintenance  | Soak.

The soaking process takes approx. 10 minutes.

Drying

This maintenance programme can be used to dry any residual moisture in the oven compartment, including in inaccessible areas.

- Dry the oven compartment with a cloth.
- Select Maintenance  | Drying.

The drying process takes approx. 20 minutes.

Rinsing

The water-carrying system is rinsed out during this maintenance programme. Any remaining food deposits are rinsed away.

- Select Maintenance  | Rinse.
- Follow the instructions on the display.

Rinsing takes approx. 10 minutes.

Descaling

We recommend using Miele descaling tablets (see “Optional accessories”) to descale the appliance. These have been specially developed for use with Miele appliances to optimise the descaling process. Other descaling agents, which contain other acids besides citric acid and/or other undesirable substances, such as chlorides for example, could cause damage to the product. Moreover, the descaling result required could not be guaranteed if the descaling solution was not of the appropriate concentration.

Do not spill descaling agent onto metal surfaces. This can cause marks to appear. However, should any descaling agent get onto these surfaces, wipe it away immediately.

The combination steam oven has to be descaled after a certain operating time. When the time comes to descale the steam oven, the number of cooking processes remaining lights up on the display. It only counts the number of cooking processes that use steam. The combination steam oven will be disabled after the last remaining cooking process.

We recommend descaling the combination steam oven before it is disabled.

Descaling takes approx. 41 minutes.

During the descaling process, the water container must be rinsed out and re-filled with fresh water. The condensate container needs to be emptied.

Carrying out the descaling process

- Select Maintenance  | Descale.

The message *Please wait* will appear on the display. The descaling process is being prepared. This may take a few minutes. As soon as the appliance is ready, you will be prompted to add descaling agent to the water container.

- Fill the water container with lukewarm water up to the level marker  and drop 2 Miele descaling tablets in it.
- Wait until the descaling tablets have dissolved.
- Push the water container into the appliance.
- Confirm with *OK*.
- Empty the condensate container.
- Confirm with *OK*.

The time left will appear on the display. The descaling process will now begin.

Do not switch the combination steam oven off during the descaling process, otherwise the whole process will have to be started from the beginning again.

During the descaling process, the water container must be rinsed out and re-filled with fresh water. The condensate container needs to be emptied.

- Follow the instructions on the display.

Once the time left has elapsed, *Finished* appears on the display and a buzzer sounds.

Finalising the descaling process

- Select *Close*.
- Remove the water container and condensate container and empty them as required.
- Clean and dry the water container and condensate container.
- Switch the combination steam oven off.
- Open the door and let the oven compartment cool down.
- Then dry the oven compartment.
- Leave the appliance door open until the oven compartment is completely dry.

Cleaning and care

HydroClean

Instead of cleaning the oven compartment manually you can run the HydroClean care programme.

Odours after preparing fish as well as heavy, stubborn soiling caused by roasting and grilling, for example, can be removed easily with this programme.

We recommend using HydroClean to clean the combination steam oven four times a year. You can also clean more frequently than this if required.

Only use Miele HydroCleaner when cleaning with HydroClean. This cleaning agent has been specially developed for your combination steam oven.

Other cleaning products may damage your combination steam oven.

1 bottle of Miele HydroCleaner is supplied with your combination steam oven. Additional bottles of HydroCleaner can be purchased from the Miele online shop, the Miele Customer Service Department or your Miele dealer.

 Risk of injury caused by cleaning agent.

HydroCleaner causes skin and severe eye irritation.

Avoid contact with skin and eyes.

In case of contact, rinse immediately with plenty of water and seek medical attention if eye irritation persists.

Keep HydroCleaner out of the reach of children.

Always use the entire contents of 1 bottle of HydroCleaner (125 ml), regardless of the degree of soiling.

The cleaning agent quantity of 125 ml is designed for the entire cleaning process and must not be changed.

You can choose between 3 levels of cleaning with different durations:

- **Degree of soiling 1** for light, barely visible soiling and odours, e.g. after preparing fish or cabbage.

Duration: approx. 1 hour 57 minutes

- **Degree of soiling 2** for visible, but not badly burnt-on soiling, e.g. dripped pizza cheese, spilled fruit-cake.

Duration: approx. 3 hours 17 minutes

- **Degree of soiling 3** for heavy soiling from various types of food that has been burnt on over a long period of time and after cooking a roast chicken, for example.

Duration: approx. 4 hours 17 minutes

Sequence of a cleaning process

HydroClean takes place in several phases:

1. Preparation
2. Cleaning phase
3. Wash phase
4. Subsequent manual cleaning
5. Drying phase

You will be guided through the entire cleaning process by the combination steam oven. To prepare for the process, you will be prompted, for example, to remove accessories from the oven compartment and to pour the cleaning agent through the floor filter.

The cleaning phase will begin when all preparations have been completed. The door will lock automatically. The cleaning agent is mixed with fresh water and sprayed across the entire oven compartment via the distribution wheel on the ceiling of the oven. This procedure is repeated multiple times.

The wash phase starts when the time left is approx. 1 hour 20 minutes. Any remaining dirt or cleaning agent residues are rinsed from the oven compartment. At the start and during this phase, the water container will need to be filled with fresh water multiple times and the condensate container will need to be emptied.

The last phase is the drying phase. This begins when the time left is approx. 30 minutes. To remove coarser residual soiling, the oven compartment must be wiped out with a damp cloth before starting the drying phase.

The cleaning process is cancelled if the combination steam oven is switched off. The combination steam oven automatically performs the wash and drying phase once it is switched back on to remove any cleaning agent residues. Normal operation is only possible once this has been completed (see also “What to do if ...” –“Messages on the display”).

Preparing for and starting the cleaning process

- Select Maintenance .
- Select HydroClean.
- Select the level of cleaning required according to the degree of soiling.
- Confirm with *OK*.

Please wait appears. Preparation for cleaning is underway. This may take a few minutes. As soon as the appliance is ready, you will be prompted to remove accessories and the side runners.

- Take all accessories out of the oven compartment.
- Take out the side runners along with the FlexiClip runners (if fitted) (see “Cleaning the side runners”).
- Confirm with *OK*.
- Insert the rubber stopper into the connection socket for the food probe.
- Lower the top heat/grill element (see “Lowering the top heat/grill element”).

Cleaning and care

- Remove coarse soiling from the oven compartment and from underneath the floor filter.
Make sure that dirt does not get into the drain hose.
- Confirm with *OK*.

Never put HydroCleaner in the water container.

Cleaning agent residues can get into the steam generator.

Only pour HydroCleaner through the floor filter.

- Check that the floor filter is fitted correctly.
- Pour the entire contents of 1 bottle of HydroCleaner through the floor filter.
Make sure that no cleaning agent gets onto the door glass or seal.
- Confirm with *OK*.
- Close the door.

Distilled or carbonated water or other liquids could damage the combination steam oven.

Only use cold, fresh drinking water.

- Rinse the water container and fill it up to the maximum marker.
- Place the water container into the compartment and confirm with *OK*.
- Empty the condensate container.
- Place the condensate container into the compartment and confirm with *OK*.

The cleaning process begins.

The time left appears on the display.

The door will lock automatically a few seconds after the process has started.

Tip: You can display the approximate time before actions need to be performed again, e.g. topping up the fresh water, by pressing **i** Info.

At the start and during the wash phase, the water container will need to be filled with fresh water three times and the condensate container will need to be emptied.

- Always follow the instructions on the display.

Before the drying phase starts, the door is unlocked again and you are prompted to wipe the oven compartment and the inside of the door with a damp cloth:

- Wipe the oven compartment (including underneath the floor filter) and the inside of the door thoroughly with a clean, damp microfibre or absorbent cloth.
- Confirm with *OK*.
- To ensure that the combination steam oven is working at its best, check the drip channel and remove any water if necessary.

⚠ Damage due to leaking water.

Leaking water can damage the housing unit and the floor.

If there is water in the drip channel, check that the door seal is fitted correctly.

If necessary, press the door seal in all the way round the door to make sure it is installed snugly and evenly.

In very adverse circumstances, water may have accumulated in the drip channel up to the height of the plateaus:

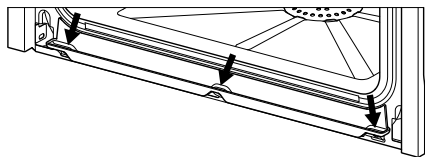

If this happens, contact the Miele Customer Service Department.

- Raise the top heat/grill element (see “Lowering the top heat/grill element”).
- Insert the side runners (see “Cleaning the side runners”).
- Place the accessories in the oven compartment.
- Confirm with *OK*.
- Close the door.
- Rinse the condensate container.
- Place the condensate container into the compartment and confirm with *OK*.

Once the time left has elapsed, *Finished* appears on the display and a buzzer sounds.

Completing the cleaning process

- Select *Close*.
- Switch the combination steam oven off.

⚠ Risk of injury caused by hot surfaces.

The combination steam oven gets hot during operation. You could burn yourself on the heater elements, oven compartment or accessories.

Allow the heater elements, oven compartment and accessories to cool down before removing any cleaning agent residue and limescale.

- Once the oven compartment has cooled down, remove any cleaning agent residue from the inside of the door, the drip channel and the door seal with a clean, damp microfibre or absorbent cloth.

Tip: Discolouration and limescale in the oven compartment can be removed using a diluted vinegar solution or DGClean (see “Optional accessories”). Then wipe with clean water.

- Dry the oven compartment and the inside of the door with a cloth.
- Leave the appliance door open until the oven compartment is completely dry.

Cleaning and care

We recommend cleaning the condensate container by hand or in the dishwasher before the next cooking process (see “Cleaning the water container and condensate container”).

Then check the drain socket is positioned correctly and that the float switch is moving freely:

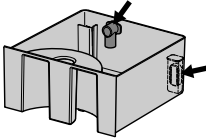

Removing the door

- Prepare a suitable underlay for the door, such as a soft cloth.
- Open the door a fraction.

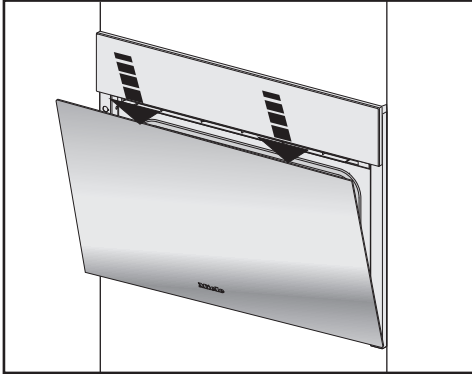

- Using both hands, press down on the top edge of the door briefly.

The oven door is connected to the door hinges by retainers. Before removing the door from the retainers, the locking clamps on both door hinges have to be released.

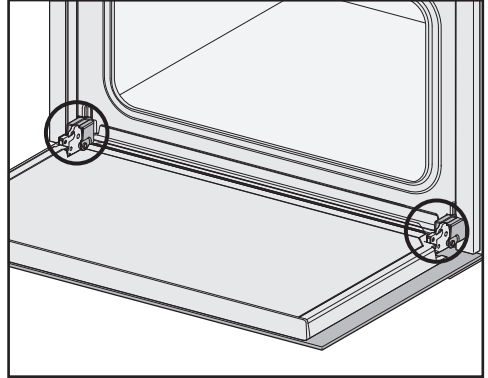

- Open the door fully.

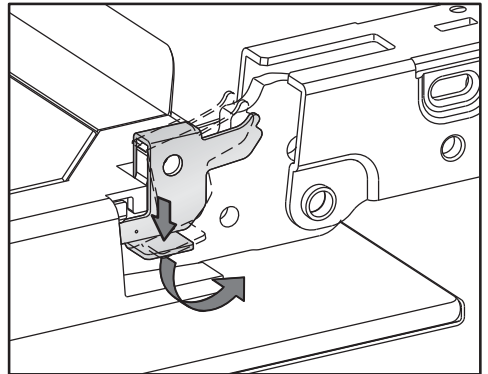

- Release the locking clamps on the hinges by turning them upwards as far as they will go until they are at an angle.

The combination steam oven could become damaged if you incorrectly remove the door.

Never pull the door horizontally off its retainers, as they will spring back against the combination steam oven. Never pull the door off the retainers by the handle, as the handle could break off.

- Raise the door up until it rests partially open.

Cleaning and care

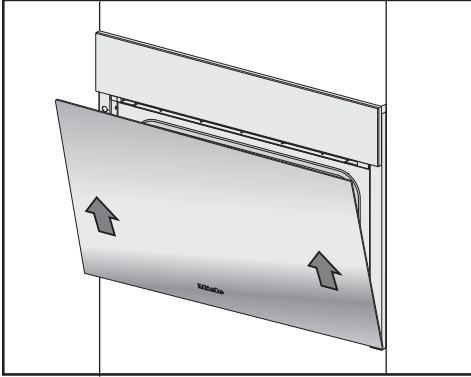

- Hold the door securely at both sides and lift it evenly upwards off the hinge retainers. Make sure that the door is straight.
- Place the door on the previously prepared surface.

If the locking clamps are not locked, the door could become loose, resulting in damage. Always ensure that the locking clamps are locked after refitting the door.

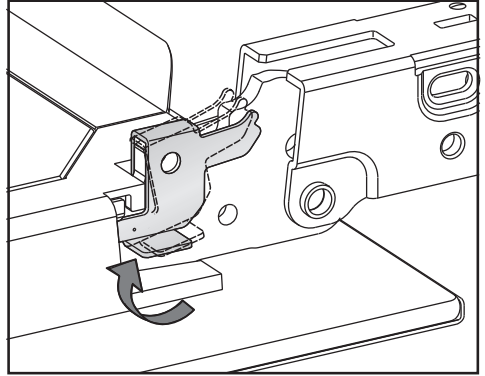

Fitting the door

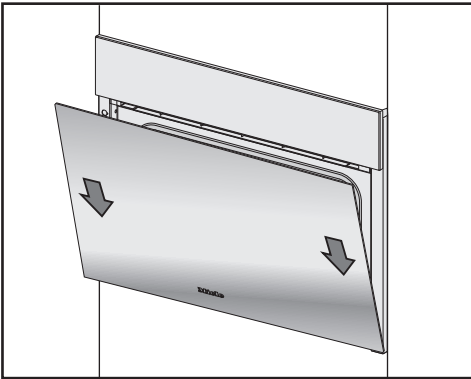

- Hold the door securely on both sides and carefully fit it back into the door hinge retainers. Make sure that you fit the door straight.
- Open the door fully.

- To relock the locking clamps, turn them back up to the horizontal position as far as they will go on both door hinges.

Problem solving guide

Many malfunctions and faults that can occur in daily operation can be easily remedied. Time and money will be saved because a service call will not be needed.

The following guide may help you to find the reason for a malfunction or a fault, and to correct it.

Messages on the display

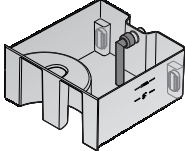
Problem	Cause and remedy
F10	<p>The suction hose in the water container is not inserted correctly or not vertical.</p> <ul style="list-style-type: none">■ Correct the position of the suction hose: 
F11 F20	<p>The drain hoses are blocked.</p> <ul style="list-style-type: none">■ Descale the combination steam oven (see “Cleaning and care” – “Care”).■ If the fault message appears again, contact the Miele Customer Service Department.
F32	<p>The door has not locked for cleaning with HydroClean.</p> <ul style="list-style-type: none">■ Switch the combination steam oven off and back on again.■ If the fault message appears again, contact the Miele Customer Service Department.
F55	<p>The maximum operating time for an operating mode has been exceeded and the auto switch off has been triggered.</p> <ul style="list-style-type: none">■ Switch the combination steam oven off and back on again. <p>The combination steam oven is ready to use again immediately.</p>

Problem solving guide

Problem	Cause and remedy
F138	<p>The combination steam oven is leaking. Water has run into the floor tray.</p> <ul style="list-style-type: none"> ■ Switch the combination steam oven off and back on again. ■ If the fault message appears again, contact the Miele Customer Service Department.
F196	<p>There is a fault.</p> <ul style="list-style-type: none"> ■ Switch the combination steam oven off and back on again.
	<p>The filter in the floor of the oven compartment is not inserted.</p> <ul style="list-style-type: none"> ■ Switch the combination steam oven off. ■ Insert the floor filter. ■ Switch the combination steam oven back on again. ■ If the fault message appears again, contact the Miele Customer Service Department.
<p>“HydroClean” continued appears when the machine is switched on.</p>	<p>The cleaning process has been cancelled due to a power cut or because the appliance has been switched off.</p> <p>The combination steam oven automatically performs the wash and drying phase once it is switched back on to remove any cleaning agent residues. This process takes approx. 1 hour 30 minutes. After a cancellation during the drying phase, the process takes approx. 30 minutes.</p> <p>Normal operation of the combination steam oven is only possible once this has been completed.</p> <ul style="list-style-type: none"> ■ Follow the instructions on the display. <p>Note that the cleaning result is not optimal.</p>
<p>A message not listed in this table is appearing on the display.</p>	<p>There is an electronic module fault.</p> <ul style="list-style-type: none"> ■ Disconnect the power supply to the combination steam oven for approx. 1 minute. ■ If the problem persists after the power supply has been restored, please contact the Miele Customer Service Department.

Unexpected behaviour

Problem	Cause and remedy
<p>The oven compartment does not heat up.</p>	<p>Demo mode is activated. The combination steam oven can be operated, however the heating elements will not work.</p> <ul style="list-style-type: none"> ■ Deactivate demo mode (see “Settings” – “Show-room programme”).
	<p>The oven compartment has been warmed up by the warming drawer in operation underneath it.</p> <ul style="list-style-type: none"> ■ Open the door and let the oven compartment cool down.
<p>After moving house, the combination steam oven no longer switches from the heating-up phase to the cooking phase.</p>	<p>The boiling temperature of the water has changed as the altitude of the new location for the appliance differs from the old one by at least 300 m.</p> <ul style="list-style-type: none"> ■ To adjust the boiling temperature, you need to descale the appliance (see “Cleaning and care” – “Care”).
<p>During operation, an unusually high amount of steam leaks out or steam leaks out from different places to usual.</p>	<p>The door is not closed properly.</p> <ul style="list-style-type: none"> ■ Close the door.
	<p>The door seal is not correctly installed.</p> <ul style="list-style-type: none"> ■ Press the door seal in all the way round the door to make sure it is installed snugly and evenly.
	<p>The door seal is damaged, e.g. cracked.</p> <ul style="list-style-type: none"> ■ Call the Miele Customer Service Department to replace the door seal. ■ Do not cook with steam or clean using HydroClean until you replace the seal.
<p>During cleaning with HydroClean, water has accumulated in the drip channel up to the level of the plateaus.</p>	<p>The combination steam oven is leaking.</p> <ul style="list-style-type: none"> ■ Remove the water and, if necessary, continue the cleaning process until the end. ■ Contact the Miele Customer Service Department.

Problem solving guide

Problem	Cause and remedy
<p>The Start at and Finish at functions are not available.</p>	<p>The temperature in the oven compartment is too high, e.g. after a programme has finished.</p> <ul style="list-style-type: none"> ■ Open the door and let the oven compartment cool down. <p>These functions are not generally available in maintenance programmes.</p>
<p>The sensor controls or the proximity sensor do not respond.</p>	<p>You have selected the Display QuickTouch Off setting. When the combination steam oven is switched off, the sensor controls and the proximity sensor do not respond.</p> <ul style="list-style-type: none"> ■ As soon as the combination steam oven is switched on, the sensor controls and the proximity sensor will respond. If you want the sensor controls and the proximity sensor to respond even when the combination steam oven is switched off, select the Display QuickTouch On setting. <p>The settings for the proximity sensor are switched off.</p> <ul style="list-style-type: none"> ■ Change the settings for the proximity sensor by selecting Settings Movement sensor. <p>The proximity sensor is defective.</p> <ul style="list-style-type: none"> ■ Contact the Miele Customer Service Department. <p>The combination steam oven is not connected to the electrical supply.</p> <ul style="list-style-type: none"> ■ Check that the combination steam oven plug is correctly inserted into the socket. ■ Check whether the fuse has tripped. Contact a qualified electrician or the Miele Customer Service Department. <p>If the display does not respond, there is a fault with the controls.</p> <ul style="list-style-type: none"> ■ Touch and hold the  On/Off sensor control until the display switches off and the combination steam oven restarts.

Noises

Problem	Cause and remedy
A humming sound can be heard during operation and after switching off the combination steam oven.	This noise does not indicate incorrect operation or an appliance fault. The noise is made by water being pumped through the system.
The fan can still be heard after the appliance has been turned off.	The fan continues to run. The combination steam oven is equipped with a fan that diverts vapours from the oven compartment outside. The fan continues to run after the combination steam oven has been turned off. The fan will turn off automatically after a short while.

Unsatisfactory results

Problem	Cause and remedy
Cakes and biscuits are not cooked properly after following the durations given in the recipe.	The temperature set is not the same as the one given in the recipe. ■ Change the temperature.
	The recipe has been altered. For example, adding more liquid or eggs can increase the cooking duration required. ■ Adapt the temperature and/or cooking duration to the altered recipe.
Cakes or biscuits are unevenly browned.	The set temperature was too high.
	More than two levels were used for baking. ■ Bake on a maximum of two levels.
There is still soiling in the oven after the HydroClean programme.	The level of cleaning chosen was too low. ■ If necessary, start HydroClean again with a higher level of cleaning.
	The oven compartment was not wiped out at all or only superficially before the start of the drying phase. ■ Start HydroClean again if necessary. ■ When the corresponding prompt appears on the display, wipe the oven compartment thoroughly with a damp cloth.

Problem solving guide

General problems or technical faults

Problem	Cause and remedy
The combination steam oven cannot be switched on.	<p>The circuit breaker has tripped.</p> <ul style="list-style-type: none">■ Reset the trip switch in the circuit breaker box (see data plate for minimum protection rating).
	<p>There may be a technical fault.</p> <ul style="list-style-type: none">■ Disconnect the combination steam oven from the electrical supply for approx. 1 minute by:<ul style="list-style-type: none">– Tripping the relevant mains fuse or unscrewing the fuse completely, or– Switching off the residual current device■ If, after resetting the trip switch in the mains fuse box or the residual current device, the combination steam oven will still not turn on, contact a qualified electrician or the Miele Customer Service Department.
The oven interior lighting is not working.	<p>The lamp is defective.</p> <ul style="list-style-type: none">■ Call Miele Service to have the lamp replaced.
The control panel will not open or close automatically despite touching the  sensor control several times.	<p>Something is obstructing the control panel.</p> <ul style="list-style-type: none">■ Remove the obstruction.
	<p>The obstruction sensor is very sensitive, which means the control panel sometimes does not open or close.</p> <ul style="list-style-type: none">■ Open/close the control panel manually (see end of this section).■ If the problem occurs frequently, contact the Miele Customer Service Department.

Problem solving guide

Problem	Cause and remedy
HydroCleaner (cleaning agent) has been put in the water container.	<p>The instructions on the display were not followed.</p> <p>If the cleaning process with HydroClean has not yet started:</p> <ul style="list-style-type: none">■ Switch the combination steam oven off to cancel the cleaning process.■ Empty the water container and rinse it thoroughly. <p>If the cleaning process with HydroClean has already been carried out:</p> <p>there may be cleaning agent residues in the steam generator that need to be removed before starting the next cooking process:</p> <ul style="list-style-type: none">■ Rinse the system four times in succession with the Rinse care programme (see “Cleaning and care” – “Care”).■ If in doubt, call the Miele Customer Service Department.

Problem solving guide

To open the panel manually

- Carefully open the appliance door.

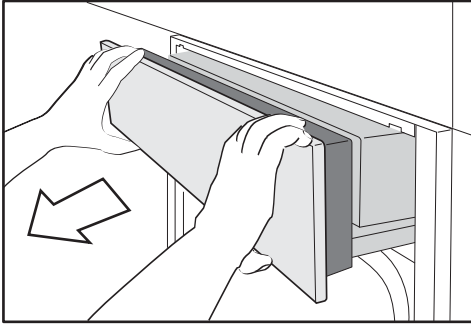

- Take hold of the panel at the top and bottom.
- Pull the panel out forwards to start with.
- Then carefully push the panel upwards.

To close the panel manually

- Take hold of the panel at the top and bottom.
- Carefully push the panel downwards.

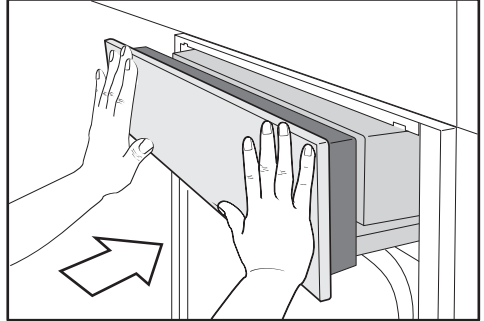

- Then push it in.

Miele offer a comprehensive range of useful accessories as well as cleaning and conditioning products for your Miele appliances.

These products can be ordered through the Miele Webshop.

They can also be ordered from Miele (see end of this booklet for contact details) or from your Miele dealer.

Containers

Miele offers a wide range of cooking containers. These have all been optimised for Miele appliances in terms of functionality and dimensions. Detailed information on each of our products can be found on the Miele website.

- Perforated cooking containers in various sizes
- Solid cooking containers in various sizes
- Gourmet oven dishes in various sizes
- Lids for Gourmet oven dishes

Other

- Baking trays
- Round baking tray
- FlexiClip runners
- Holding rack for cooking containers with a width of 325 mm

Cleaning and care products

- HydroCleaner
Special cleaning agent for cleaning the oven compartment with the HydroClean care programme. Particularly suitable for removing heavy, stubborn soiling.
- DGClean
Special cleaning agent for manually removing stubborn soiling from the oven compartment, particularly after roasting.
- Descaling tablets (6)
- All-purpose microfibre cloth
For removing finger marks and light soiling

Service

Contact in the event of a fault

In the event of any faults which you cannot remedy yourself, please contact your Miele dealer or the Miele Customer Service Department.

You can book a Miele Customer Service Department call-out online at www.miele.com/service.

Contact information for the Miele Customer Service Department can be found at the end of this document.

Please quote the model identifier and serial number of your appliance (Fabr./SN/Nr.) when contacting the Miele Customer Service Department. This information can be found on the data plate.

Please note that telephone calls may be monitored and recorded for training purposes and that a call-out charge will be applied to service visits where the problem could have been resolved as described in this booklet.

When the appliance is installed, the model identifier and the serial number can be found on the small plate at the top on the opened control panel.

Warranty

For information on the appliance warranty specific to your country please contact Miele. See back cover for address.

In the UK, your appliance warranty is valid for 2 years from the date of purchase. However, you must activate your cover by calling 0330 160 6640 or registering online at www.miele.co.uk.

Safety instructions for installation

 Risk of damage from incorrect installation.

Incorrect installation can cause damage to the combination steam oven.

The combination steam oven must only be installed by a specialist.

- ▶ The connection data (voltage and frequency) on the data plate of the combination steam oven must match the electrical supply in order to avoid the risk of damage to the oven. Compare this data before connecting the appliance. If in any doubt, consult a qualified electrician.
- ▶ Multi-socket adapters and extension leads do not guarantee the required safety of the appliance (fire hazard). Do not use these to connect the combination steam oven to the electrical supply.
- ▶ The socket should be easily accessible after the combination steam oven has been installed.
- ▶ The combination steam oven must be positioned so that you can see the contents of a cooking container placed on the top shelf level. Otherwise there is a risk of injuries due to spillages of hot food.

Installation

Building-in dimensions

All dimensions are given in mm.

Installation in a tall unit

The furniture housing unit must not have a back panel fitted behind the building-in niche.

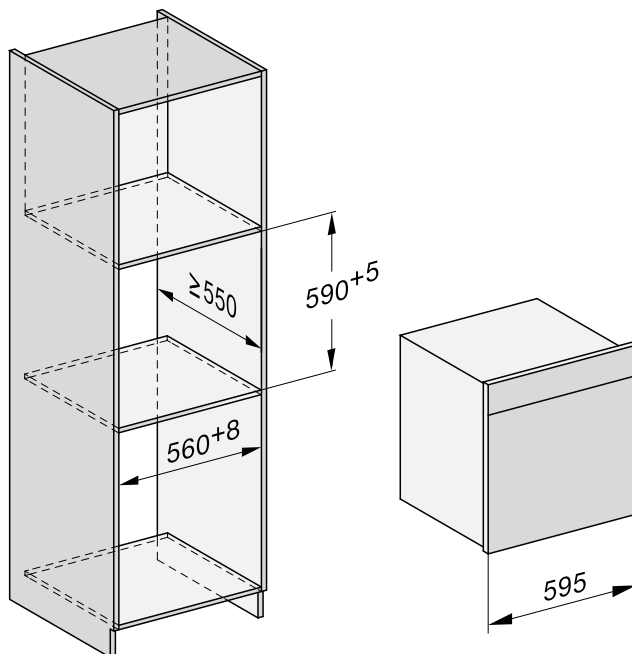

Installation in a base unit

The furniture housing unit must not have a back panel fitted behind the building-in niche.

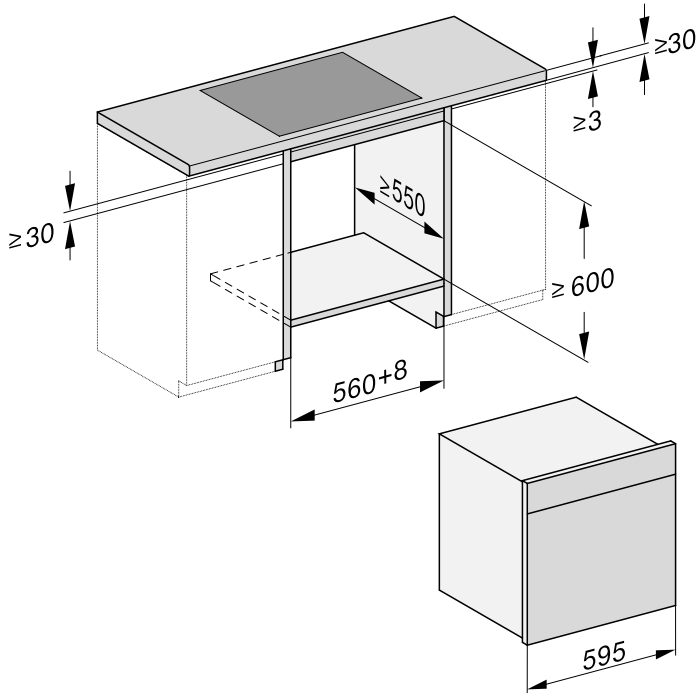

Installation

Side view

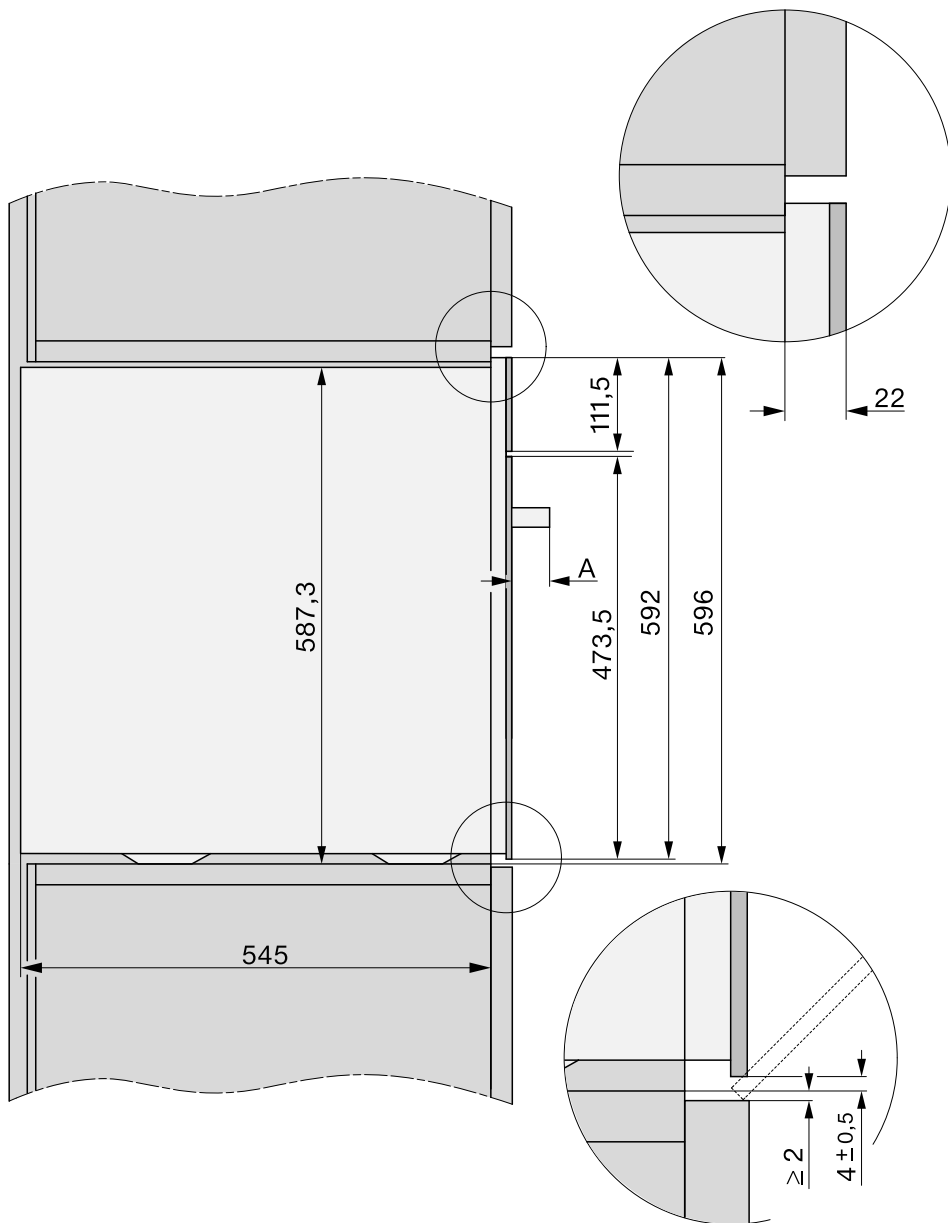

A DGC 76xx: 47 mm

Swivel range for control panel

The area in front of the control panel must not be blocked by anything (such as a door handle) that would hinder it from opening and shutting.

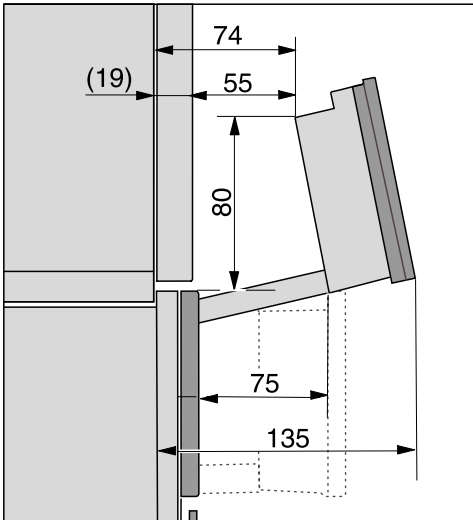

Installation

Connection and ventilation

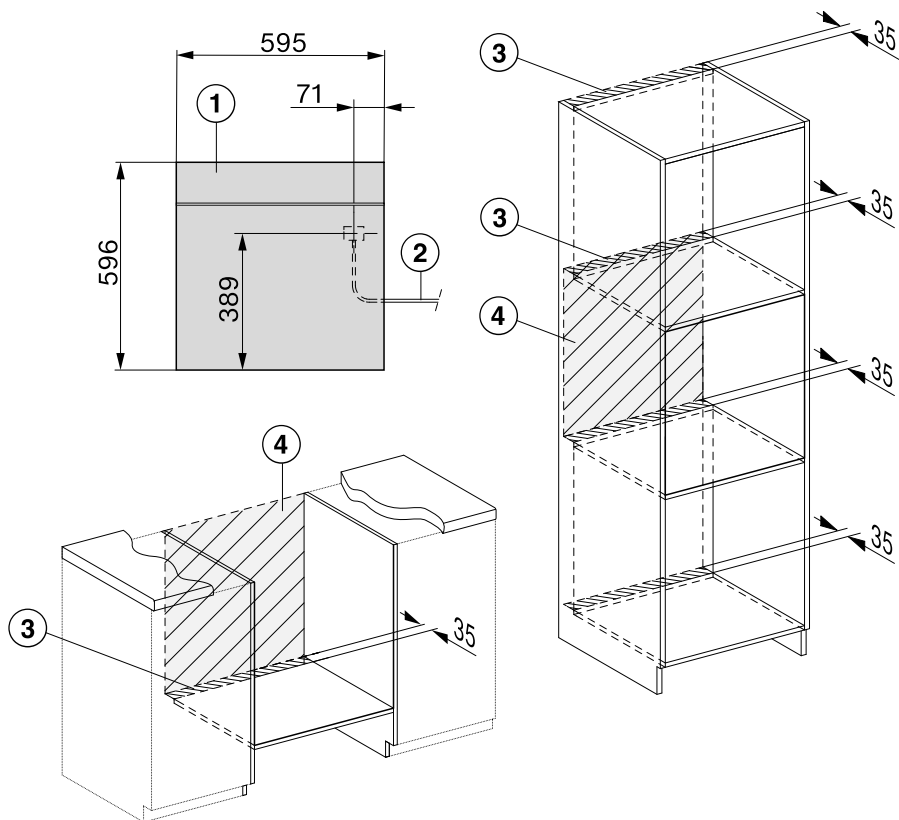

- ① Front view
- ② Mains connection cable, L = 2.000 mm
- ③ Ventilation cut-out, min. 180 cm²
- ④ No connections permitted in this area

Installing the combination steam oven

- Connect the mains connection cable to the combination steam oven.

Risk of damage from incorrect transportation.

Carrying the combination steam oven by the door handle could damage the door.

Use the handle cut-outs on the side of the casing to lift the appliance.

The steam generator may malfunction if the combination steam oven is not on a level surface.

The maximum deviation from the horizontal that can be tolerated is 2°.

- Push the combination steam oven into the building-in niche and align it. When doing so make sure that the mains connection cable does not get trapped or damaged.
- Open the door.

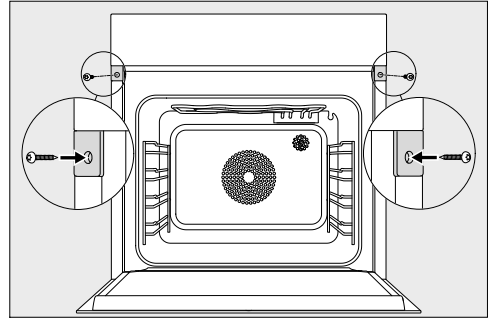

- Secure the combination steam oven to the side walls of the cabinet using the wood screws included (3.5 x 25 mm).
- Connect the combination steam oven to the electrical supply.
- Check all functions of the combination steam oven are working correctly in accordance with the operating instructions.

Installation

Electrical connection

The combination steam oven is supplied with a mains cable with moulded plug ready for connection to a suitable earthed socket.

The socket must be easily accessible after the combination steam oven has been installed. If the socket is not easily accessible, ensure that a suitable means of disconnection is provided on the installation side for each pole.

 Risk of fire from overheating. Connecting the combination steam oven to multi-socket adapters or extension cables can overload the cables. For safety reasons, do not use an extension cable or multi-socket adapter.

The electrical installation must comply with BS 7671 requirements.

For safety reasons, we recommend using a type  residual current device (RCD) in the relevant electrical installation for connecting the combination steam oven.







If the mains connection cable is damaged, it must only be replaced with a specific mains connection cable of the same type (available from the Miele Customer Service Department). For safety reasons, such replacement may only be carried out by a qualified specialist or the Miele Customer Service Department.

These operating instructions and the data plate indicate the nominal power consumption and the appropriate fuse rating. Compare this information with the data of the on-site electrical connection.

If in any doubt, consult a qualified electrician.

Temporary or permanent operation on an autonomous power supply system or a power supply system that is not synchronised with the mains power supply (e.g. island networks, back-up systems) is possible. A prerequisite for operation is that the power supply system complies with the specifications of EN 50160 or an equivalent standard. The function and operation of the protective measures provided in the domestic electrical installation and in this Miele product must also be maintained in isolated operation or in operation that is not synchronised with the mains power supply, or these measures must be replaced by equivalent measures in the installation. As described, for example, in the current version of BS OH-SAS 18001–2 ISO 45001.

Test food according to EN 60350-1 (steam cooking functions)



Test food	Cooking con- tainers	Quantity [g]	 ³		 ¹ [°C]	 [min]
Steam replenishment						
Broccoli (8.1)	1x DGGL 12	max.	2		100	3
Steam distribution						
Broccoli (8.2)	1x DGGL 20	300	2		100	3
Appliance capacity						
Peas (8.3)	2x DGGL 12	1500 each	1, 3		100	<u>2</u>

³ Level,  Function, ¹ Temperature,  Cooking duration

 Steam cooking,  Eco steam cooking

- 1 Place the test food in a cold oven compartment (before the heating-up phase begins).
- 2 The test is finished when the temperature measures 85 °C in the coolest place.

Menu cooking test food¹ (steam cooking operating mode















Test food	Cooking con- tainers	Quantity [g]	 ²	 [°C]	Height [cm]	 [min]
Potatoes, waxy, quartered ³	1x DGGL 12	1200	4	100	–	17
Salmon fillet, frozen, not defrosted	1x DGGL 12	6 x 150	2	100	< 2.5 ≥ 2.5 ≤ 3.2 > 3.2	9 10 11
Broccoli florets	1x DGGL 12	900	3	100	–	4

³ Shelf level, ¹ Temperature,  Cooking duration





- 1 For instructions, see “Menu cooking – manual” in the “Steam cooking” chapter.
- 2 Place the universal tray on shelf level 1.
- 3 Place the 1st test food item (potatoes) in a cold oven compartment (before the heating-up phase begins).

Note for test institutes

Test food according to EN 50304/EN 60350-1 (oven functions)

Test food	Accessories	 ³		 [°C]	 ² [min]		Pre-heat- ing
Shortbread biscuits (7.5.2)	1 baking tray	3		140	34–36 (35)	No	No
	2 baking trays	2		140	39–41 (40)	No	No
		4 ¹			36–38 (37)		
	1 baking tray	3		140	29–31 (28)	Yes	Yes
Small cakes (7.5.3)	1 baking tray	1		150	35–37 (37)	No	No
	2 baking trays	2, 4		140	43–45 (44)	No	No
Whisked sponge (7.6.1)	1 springform cake tin 26 cm (on rack)	3		160	30–32 (31)	Yes	Yes
Apple sponge (7.6.2)	1 springform cake tin 20 cm (on rack)	2		160	95–105 (100)	No	No
	2 springform cake tins 20 cm (on rack)	2		160	85–95 (90)	Yes	Yes
Industrially produced white bread (9.2)	Rack	3		Level 3	5	No	6 min.
Burger (9.3)	Rack	4		Level 3	1st side: 10 2nd side: 6	No	8 min.
	Universal tray	3					

³ Level,  Function,  Temperature/grill level, ² Cooking duration,  Booster

 Fan plus,  Conventional heat,  Cake plus,  Full grill

1 Take the trays out of the oven early if the food is sufficiently browned before the specified cooking duration has elapsed.

2 The value in brackets states the optimum cooking duration.

Energy efficiency class according to EN 60350-1

The energy efficiency class is determined in accordance with EN 60350-1.

Energy efficiency class: A+

Please observe the following when conducting testing:

- Testing is undertaken using the Eco Fan heat  operating mode.
- Select the Lighting | “On” for 15 seconds setting (see “Settings” – “Lighting”).
- Select the Movement sensor | Switch the light on | Off setting (see “Settings” – “Movement sensor”).
- Only accessories that are required for testing should be in the oven compartment during tests. Do not use any other available accessories such as FlexiClip runners.
- The thermocouples must be inserted through the door seal for the test. To do this, pull the door seal out of its groove and pierce it twice. Insert the thermocouples through the two holes in the door seal. Then press the door seal firmly back into the groove so that it fits snugly and evenly all over.

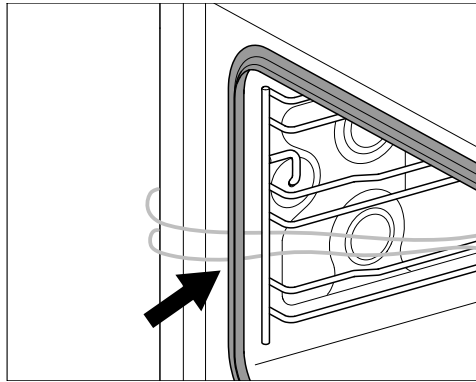

- In the next step, remove the floor filter and pour water into the drain until the surface of the water is visible.
- An important pre-condition for determining the energy efficiency class is that the door is tightly shut during testing. Depending on measurement devices used, the functioning of the door seal can be affected to a greater or lesser extent. This has a negative impact on the test results.

Note for test institutes

Data sheet for household ovens

In acc. with delegated regulation (EU) No. 65/2014 and regulation (EU) No. 66/2014

MIELE	
Model name/identifier	DGC 7660 HC Pro
Energy efficiency index/cavity (EEI _{cavity})	81,8
Energy efficiency class/cavity	
A+++ (most efficient) to D (least efficient)	A+
Energy consumption per cycle for each cavity in conventional mode	1,08 kWh
Energy consumption per cycle for each cavity in fan-forced convection mode	0,68 kWh
Number of cavities	1
Heat source(s) per cavity	electric
Volume of cavity	67 l
Mass of the appliance	46,4 kg

UK Conformity declaration

Miele hereby declares that this steam combination oven complies with UK Radio Equipment Regulations 2017, as amended.

The complete text of the UK declaration of conformity is available from one of the following internet addresses:

- Products, Download from www.miele.co.uk
- For service, information, operating instructions etc: go to www.miele.co.uk and enter the name of the product or the serial number

Frequency range of the WiFi module	2.4000–2.4835 GHz
------------------------------------	-------------------

Maximum transmission power of the WiFi module	< 100 mW
---	----------

EU Conformity declaration

Miele hereby declares that this steam combination oven complies with Directive 2014/53/EU.

The complete text of the EU declaration of conformity is available from one of the following internet addresses:

- Products, Download from www.miele.ie
- For service, information, operating instructions etc: go to www.miele.ie/domestic/customer-information-385.htm and enter the name of the product or the serial number

Frequency range of the WiFi module	2.4000–2.4835 GHz
------------------------------------	-------------------

Maximum transmission power of the WiFi module	< 100 mW
---	----------

Copyrights and licences

For the purpose of operating and controlling the communication module, Miele uses proprietary or third-party software that is not covered by open source licensing terms. This software/these software components are protected by copyright. The copyrights held by Miele and third parties must be respected.

Furthermore, the communication module integrated in the appliance contains software components which are distributed under open source licence conditions. The open source components contained in the appliance along with the corresponding copyright notices, copies of the licensing terms valid at the time and any further information can be accessed locally by IP via a web browser ([http\[s\]://<IP address>/Licenses](http[s]://<IP address>/Licenses)). The liability and warranty arrangements for the open source licences displayed in this location only apply in relation to the respective rights holders.

United Kingdom

Miele Co. Ltd., Fairacres, Marcham Road, Abingdon, Oxon, OX14 1TW

Tel: 0330 160 6600, Internet: www.miele.co.uk/service, E-mail: info@miele.co.uk

Australia

Miele Australia Pty. Ltd.

ACN 005 635 398

ABN 96 005 635 398

Level 4, 141 Camberwell Road

Hawthorn East, VIC 3123

Tel: 1300 464 353

Internet: www.miele.com.au

China Mainland

Miele Electrical Appliances Co., Ltd.

1-3 Floor, No. 82 Shi Men Yi Road

Jing' an District

200040 Shanghai, PRC

Tel: +86 21 6157 3500

Fax: +86 21 6157 3511

E-mail: info@miele.cn,

Internet: www.miele.cn

Hong Kong, China

Miele (Hong Kong) Ltd.

41/F - 4101, Manhattan Place

23 Wang Tai Road

Kowloon Bay, Hong Kong

Tel: (852) 2610 1025

Fax: (852) 3579 1404

Email:

customerservices@miele.com.hk

Website: www.miele.hk

India

Miele India Pvt. Ltd.

1st Floor, Copia Corporate Suites,

Commercial Plot 9,

Mathura Road, Jasola,

New Delhi - 110025

E-mail: customercare@miele.in

Website: www.miele.in

Manufacturer: Miele & Cie. KG, Carl-Miele-Straße 29, 33332 Gütersloh, Germany

Ireland

Miele Ireland Ltd.

2024 Bianconi Avenue

Citywest Business Campus

Dublin 24

Tel: (01) 461 07 10

Fax: (01) 461 07 97

E-Mail: info@miele.ie

Internet: www.miele.ie

Kuwait

Miele Kuwait

Al Wazzan United Trading Co.

P. O. Box : 3379

Hawally, 32034 Kuwait

Tel.: 00965-22001010

Fax: 00965-24838292

E-mail: mail@alwazzanunited.com

Website: www.alwazzanunited.com

Malaysia

Miele Sdn Bhd

Suite 12-2, Level 12

Menara Sapura Kencana

Petroleum

Solaris Dutamas No. 1

Jalan Dutamas 1

50480 Kuala Lumpur, Malaysia

Phone: +603-6209-0288

Fax: +603-6205-3768

New Zealand

Miele New Zealand Limited

IRD 98 463 631

8 College Hill

Freemans Bay, Auckland 1011

New Zealand

Tel: 0800 464 353

Internet: www.miele.co.nz

Singapore

Miele Pte. Ltd.

29 Media Circle

#11-04 ALICE@Mediapolis

Singapore 138565

Tel: +65 6735 1191

Fax: +65 6735 1161

E-Mail: info@miele.com.sg

Internet: www.miele.sg

South Africa

Miele (Pty) Ltd.

63 Peter Place, Bryanston 2194

P.O. Box 69434, Bryanston 2021

Tel: (011) 875 9000

Fax: (011) 875 9035

E-mail: info@miele.co.za

Internet: www.miele.co.za

Thailand

Miele Appliances Ltd.

BHIRAJ TOWER at EmQuartier

43rd Floor Unit 4301-4303

689 Sukhumvit Road

North Klongton Sub-District

Vadhana District

Bangkok 10110, Thailand

United Arab Emirates

Miele Appliances Ltd.

Showroom 1, Eiffel 1 Building

Sheikh Zayed Road, Umm Al Sheif

P.O. Box 114782 - Dubai

Tel. +971 4 3044 999

Fax. +971 4 3418 852

800-MIELE (64353)

E-Mail: info@miele.ae

Website: www.miele.ae

DGC 7660 HC Pro

en-GB

M.-Nr. 12 200 600 / 00