

# Heat Pump Dryer

---

User manual

DV9\*BB5245\*\*

---



**SAMSUNG**

# Contents

---

|  |           |
|--|-----------|
| <b>Safety information</b>  | <b>4</b>  |
| What you need to know about the safety instructions                              | 4         |
| Important safety symbols   | 4         |
| Important safety precautions   | 5         |
| To minimize the risk of fire in a tumble dryer, the following should be observed | 8         |
| Critical installation warnings   | 9         |
| Critical usage warnings  | 11        |
| Usage cautions   | 12        |
| Critical cleaning warnings   | 13        |
| Care for preventing freezing   | 13        |
| Instructions about the WEEE  | 14        |
| <b>Installation</b>  | <b>15</b> |
| What's included  | 15        |
| Installation requirements  | 17        |
| Step-by-step installation  | 18        |
| Door reversal  | 22        |
| Environment  | 26        |
| <b>Before you start</b>  | <b>27</b> |
| Initial setup  | 27        |
| Drying guidelines  | 28        |
| <b>Operations</b>  | <b>30</b> |
| Control panel  | 30        |
| Operating a cycle  | 32        |
| Cycle overview   | 33        |
| Options  | 35        |
| System functions   | 37        |
| Special features   | 39        |
| <b>Maintenance</b>   | <b>43</b> |
| Emptying the water tank  | 43        |
| Cleaning   | 44        |

---

|                            |           |
|----------------------------|-----------|
| <b>Troubleshooting</b>     | <b>49</b> |
| Checkpoints                | 49        |
| Information codes          | 51        |
| <b>Appendix</b>            | <b>53</b> |
| Fabric care chart          | 53        |
| Protecting the environment | 54        |
| Specification              | 55        |
| Consumption data           | 56        |
| Specification sheet        | 57        |
| <b>Contact information</b> | <b>58</b> |
| QUESTIONS OR COMMENTS?     | 58        |

# Safety information

Congratulations on your new Samsung dryer. This manual contains important information on the installation, use, and care of your appliance. Please take the time to read this manual to take full advantage of your dryer's many benefits and features.

## What you need to know about the safety instructions

Warnings and Important Safety Instructions in this manual do not cover all possible conditions and situations that may occur. It is your responsibility to caution and care when installing, maintaining, or operating your dryer.

Always contact your manufacturer about problems or conditions you do not understand.

## Important safety symbols

What the icons and signs in this user manual mean:

### WARNING

Hazards or unsafe practices that may result in severe personal injury, death and/or property damage.

### CAUTION

Hazards or unsafe practices that may result in personal injury and/or property damage.

### WARNING

To reduce the risk of fire or explosion, follow these basic precautions.

### NOTE

Indicates that a risk of personal injury or material damage exists.

### CAUTION

#### **Risk of fire/risk of poisoning/risk of material damage and damage to the appliance**

The appliance contains R290, a refrigerant that is environmentally friendly but flammable. If it is not disposed of correctly, this may result in fire or poisoning.

Dispose of the appliance correctly and do not damage the pipes in the refrigerant circuit.

### Read the instructions

These warning signs are here to prevent injury to yourself and others.

Please follow them explicitly.

After reading this manual, store it in a safe place for future reference.

Read all instructions before using the appliance.

As with any equipment that uses electricity and moving parts, potential hazards exist. To safely operate this appliance, familiarize yourself with its operation and exercise care when using it.

 **WARNING****Risk of Fire**

- Clothes dryer installation must be performed by a qualified technician.
- Install the clothes dryer according to the manufacturer's instructions and local codes.
- To reduce the risk of severe injury or death, follow all installation instructions.

**Important safety precautions** **WARNING**

**To reduce the risk of fire, electric shock, or injury to persons when using your appliance, follow basic precautions, including the following:**

1. This appliance is not to be used by persons (including children) with reduced physical, sensory or mental capabilities, or lack of experience and knowledge, unless they have been given supervision or instruction concerning use of the appliance by a person responsible for their safety.
2. **For use in Europe:** This appliance can be used by children aged from 8 years and above and persons with reduced physical, sensory or mental capabilities or lack of experience and knowledge if they have been given supervision or instruction concerning use of the appliance in a safe way and understand the hazards involved. Children shall not play with the appliance. Cleaning and user maintenance shall not be made by children without supervision.
3. Children should be supervised to ensure that they do not play with the appliance.

## Safety information

---

4. If the supply cord is damaged, it must be replaced by the manufacturer, its service agent or similarly qualified persons in order to avoid a hazard.
5. For appliances with ventilation openings at the base, make sure that items such as carpets or mats do not obstruct the openings.
6. **For use in Europe:** Children of less than 3 years should be kept away unless continuously supervised.
7. **CAUTION:** In order to avoid a hazard due to inadvertent resetting of the thermal cut-out, this appliance must not be electrical connected through an external switching device, such as a timer, or connected to a circuit that is regularly switched on and off by the utility.
8. The tumble dryer is not to be used if industrial chemicals have been used for cleaning.
9. The lint trap has to be cleaned frequently if applicable.
10. Lint must not to be allowed to accumulate around the tumble dryer.  
(not applicable for appliances intended to be vented to the exterior of the building)
11. Adequate ventilation has to be provided to avoid the back flow of gases into the room from appliances burning other fuels, including open fires.
12. Do not dry unwashed items in the tumble dryer.

13. Items that have been soiled with substances such as cooking oil, acetone, alcohol, petrol, kerosene, spot removers, turpentine, waxes and wax removers should be washed in hot water with an extra amount of detergent before being dried in the tumble dryer.
14. Items such as foam rubber (latex foam), shower caps, waterproof textiles, rubber backed articles and clothes or pillows fitted with foam rubber pads should not be dried in the tumble dryer.
15. The final part of a tumble dryer cycle occurs without heat (cool down cycle) to ensure that the items are left at a temperature that ensures such items will not be damaged.
16. Remove all objects from pockets such as lighters and matches.
17. **WARNING:** Never stop a tumble dryer before the end of the drying cycle unless all items are quickly removed and spread out so that the heat is dissipated.
18. Exhaust air must not be discharged into a flue which is used for exhausting fumes from appliances burning gas or other fuels.
19. The appliance must not be installed behind a lockable door, a sliding door or a door with a hinge on the opposite side to that of the tumble dryer, in such a way that a full opening of the tumble dryer door is restricted.
20. **WARNING:** The appliance must not be supplied through an external switching device, such as a timer, or connected to a circuit that is regularly switched on and off by a utility.

## Safety information

---

21. Fabric softeners, or similar products, should be used as specified by the fabric softener instructions.



### **WARNING; RISK OF FIRE / FLAMMABLE MATERIALS**

22. **WARNING:** In the appliance enclosure or in the built-in structure, keep ventilation openings clear of obstruction.

23. **WARNING:** Do not damage the refrigerant circuit.

24. The appliance contains R290, a refrigerant that is environmentally friendly but flammable.

Keep fire and ignition sources away from the appliance.

### **To minimize the risk of fire in a tumble dryer, the following should be observed**

---

#### **⚠ WARNING**

Items that have been spotted or soaked with vegetable or cooking oil constitute a fire hazard and should not be placed in a tumble dryer. Oil-affected items can ignite spontaneously, especially when exposed to heat sources such as in a tumble dryer. The items become warm, causing an oxidation reaction in the oil. Oxidation creates heat. If the heat cannot escape, the items can become hot enough to catch fire. Piling, stacking or storing oil-affected items can prevent heat from escaping and so create a fire hazard. If it is unavoidable that fabrics that contain vegetable or cooking oil or have been contaminated by hair care products be placed in a tumble dryer they should first be washed in hot water with extra detergent – this will reduce, but not eliminate, the hazard. The 'cool down' cycle of tumble dryers should be used to reduce the temperature of the items. They should not be removed from the tumble dryer or piled or stacked while hot.

Items that have been previously cleaned in, washed in, soaked in or spotted with petrol/gasoline, drycleaning solvents or other flammable or explosive substances should not be placed in a tumble dryer. Highly flammable substances commonly used in domestic environments include acetone, denatured alcohol, petrol/gasoline, kerosene, spot removers(some brands), turpentine, waxes and wax removers.

Items containing foam rubber(also known as latex foam) or similarly textured rubber. Like materials should not be dried in a tumble dryer on a heat setting. Foam rubber materials can, when heated, produce fire by spontaneous combustion.

Fabric softeners or similar products should not be used in a tumble dryer to eliminate the effects of static electricity unless this practice is specifically recommended by the manufacturer of the fabric softener or product.

Undergarments that contain metal reinforcements should not be placed in a tumble dryer. Damage to the tumble dryer can result if metal reinforcements come loose during drying. A drying rack should be used for such items.

Plastic articles such as shower caps or babies' waterproof napkin covers should not be placed in a tumble dryer.

Rubber-backed articles, clothes fitted with foam rubber pads, pillows, galoshes and rubber-coated tennis shoes should not be placed in a tumble dryer.

Do not dry unwashed items in the tumble dryer (or washing machine drying mode, etc).

Items that have been soiled with substances such as cooking oil, acetone, alcohol, petrol, Kerosene, spot removers, turpentine, waxes and wax removers should be washed in hot water with an extra amount of detergent before being dried in the tumble dryer.

Items such as foam rubber (latex foam), shower caps, waterproof textiles, rubber backed articles and clothes or pillows fitted with foam rubber pads should not be dried in the tumble dryer.

The final part of a tumble dryer cycle occurs without heat (cool down cycle) to ensure that the items are left at a temperature that ensures that the items will not be damaged.

Oil-affected items can ignite spontaneously, especially when exposed to heat sources such as in a tumble dryer. The items become warm, causing an oxidation reaction in the oil. Oxidation creates heat. If the heat cannot escape, the items can become hot enough to catch fire. Piling, stacking or storing oil-affected items can prevent heat from escaping and so create a fire hazard.

If it is unavoidable that fabrics that contain vegetable or cooking oil or have been contaminated by hair care products be placed in a tumble dryer they should first be washed in hot water with extra detergent - this will reduce, but will not eliminate, the hazard.

Never stop a tumble dryer before the end of the drying cycle unless all items are quickly removed and spread out so that the heat is dissipated.

Remove all objects from pockets such as lighters and matches.

The tumble dryer (or washing machine drying mode, etc) is not to be used if industrial chemicals have been used for cleaning.

## Critical installation warnings

### WARNING

The installation of this appliance must be performed by a qualified technician or service company.

- Failure to do so may result in electric shock, fire, an explosion, problems with the product, or injury.

Plug the power cord into a wall socket and use the socket for this appliance only. In addition, do not use an extension cord.

- Sharing a wall socket with other appliances using a power strip or extending the power cord may result in electric shock or fire.

# Safety information

- Ensure that the power voltage, frequency and current are the same as those of the product specifications. Failure to do so may result in electric shock or fire. Failure Plug the power plug into the wall socket firmly.

Remove all foreign substances such as dust or water from the power plug terminals and contact points using a dry cloth on a regular basis.

- Unplug the power plug and clean it with a dry cloth.
- Failure to do so may result in electric shock or fire.

Keep all packaging materials well out of the reach of children, as packaging materials can be dangerous to children.

- If a child places a bag over its head, it may result in suffocation.

This appliance must be properly grounded.

Do not ground the appliance to a gas pipe, plastic water pipe, or telephone line.

- This may result in electric shock, fire, an explosion, or problems with the product
- Never plug the power cord into a socket that is not grounded correctly and make sure that it is in accordance with local and national codes.

Do not install or keep the product exposed to the outdoor elements.

Do not use a damaged power plug, damaged power cord or loose wall socket.

- This may result in electric shock or fire.

If the plug (power supply cord) is damaged, it must be replaced by the manufacturer, its service agent or a similar qualified technician in order to avoid a hazard.

This appliance should be positioned to be accessible to the power plug after installation.

Do not pull or excessively bend the power cord.

Do not twist or tie the power cord.

Do not hook the power cord over a metal object, place a heavy object on the power cord, insert the power cord between objects, or push the power cord into the space behind the appliance.

- This may result in electric shock or fire.

Do not pull the power cord, when unplugging the power plug.

- Unplug the power plug by holding the plug.
- Failure to do so may result in electric shock or fire.

This appliance must be properly grounded. Never plug the power cord into a receptacle that is not grounded adequately and in accordance with local and national codes. See installation instructions for grounding this appliance.

Install this appliance in a location with solid, level floor.

- Failing to do so may result in abnormal vibrations, noise or problems with the product.

Since an ingredient in hair spray may degrade the hydrophile property of the heat exchanger so that dew may appear on the outer surface of the appliance when the cooling operation is running, do not install the appliance in a beauty salon.

This appliance should be positioned so that the power plug, the water supply taps, and the drain pipes are accessible.

## Critical usage warnings

### WARNING

Do not let children or pets on or into the product. In addition, when disposing of this product, disassemble the door lock (lever).

- This may result in children falling and injuring themselves.
- If children become locked in the product, there is a danger of suffocation.

Do not try to access the inside of the product when the drum is rotating.

Do not sit on the product or lean against the door.

- This may result in the product turning over and resulting in injury.

Dry the laundry only after it was spun by an appropriate washing machine.

Do not dry unwashed items in the tumble dryer.

Do not drink the condensed water.

Never stop a tumble dryer before the end of the drying cycle unless all items are quickly removed and spread out so that the heat is dissipated.

Do not dry laundry contaminated by inflammable materials such as gasoline, kerosene, benzene, thinner, alcohol, etc.

- This may result in electric shock, fire or explosion.

Do not let pets chew or play with the dryer.

- This may result in electric shock or injury.

When disposing of the product, separate the door and the power cord before disposing of the product.

- Failing to do so may result in damage to the power cord or an injury.

Do not touch the power plug with wet hands.

- This may result in electric shock.

When gas (city gas, propane gas, LP gas) leaks, do not touch this appliance or the power cord, ventilate immediately.

- Do not use an electric fan to ventilate.
- A spark may cause an explosion or fire.

Do not repair, replace, or attempt to service any part of the appliance unless specifically recommended in the user-repair instructions. You must also have the necessary skills to service this appliance.

Do not attempt to repair, disassemble, or modify the appliance yourself.

- Do not use any fuse (such as copper, steel wire, etc.) other than the standard fuse.
- When repairing or reinstalling the appliance is required, contact your nearest service center.
- Failure to do so may result in electric shock, fire, problems with the product, or injury.

The product you have purchased is designed for domestic use only.

The use for business purposes qualifies as product misuse. In this case, the product will not be covered by the standard warranty provided by Samsung and no responsibility can be attributed to Samsung for malfunctions or damages resulting from such misuse.

# Safety information

---

If the product generates strange noise, smells of something burning, or generates smoke, immediately cutoff the power and contact the service center.

- Otherwise, it may cause an electric shock or fire as a result.

Do not let children (or pets) play in or on your product. The product door does not open easily from the inside and children may be seriously injured if trapped inside.

## Usage cautions

---

### CAUTION

Do not stand on top of the appliance or place objects (such as laundry, lighted candles, lighted cigarettes, dishes, chemicals, metal objects, etc.) on the appliance.

- This may result in electric shock, fire, problems with the product, or injury.

Do not touch the glass door and inside of the drum during or just after drying as it is hot.

- This may result in burns.

The door glass becomes hot during drying. Therefore, do not touch the door glass.

Also, do not allow children to play around the dryer or touch the door glass.

- This may result in burns.

Do not press the buttons using sharp objects such as pins, knives, fingernails, etc.

- This may result in electric shock or injury.

Do not dry laundry containing forming rubber such as latex or similar rubber textures.

- If forming rubber is heated, it may deform or start a fire.

Do not dry laundry contaminated by vegetable oil or cooking oil as a large amount of the oil will not be removed when washing the laundry. In addition, use the unheated dry cycle so that the laundry is not heated.

- The oxidization heat of the oil may start a fire.

Do not dry laundry contaminated by foreign substances such as oil, cream, lotion, or other chemicals that are used in places such as skincare room, massage parlor, beauty salon, or hospital.

- This may result in electric shock, fire, malfunction, and injury.

Make sure that the pockets of all clothing to be dried are empty.

- Hard, sharp objects, such as coins, safety pins, nails, screws, or stones can cause extensive damage to the appliance.

Do not dry clothing with large buckles, buttons, or other heavy metal (zippers, hooks and eyelets, button-up covers).

If necessary, use the laundry net for small and lightweight laundry such as fabric tie belt, apron strings, and underwire bras which can dissolve or break during a cycle.

Dryer sheets are compatible with this model, and are recommended for better drying performance.

Dryer sheets are also beneficial in reducing the static electricity generated during a drying cycle. Static electricity could lead to damage of laundry items and potentially the appliance.

Do not use the dryer near dangerous powders such as coal dust, wheat flour, etc.

- This may result in electric shock, fire or an explosion.

Do not place inflammable materials near the product.

- This may result in toxic gases from the product, damage to parts, electric shock, fire or an explosion.
- The appliance should not be placed behind lockable doors etc.

Do not touch the rear side of the appliance during or immediately after drying is complete.

- The appliance remains hot and may cause burns.

## Critical cleaning warnings

### WARNING

Do not clean the appliance by spraying water directly onto it.

Do not use benzene, thinner or alcohol to clean the appliance.

- This may result in discoloration, deformation, damage, electric shock or fire.

Before cleaning or performing maintenance, unplug the appliance from the wall socket.

- Failure to do so may result in electric shock or fire.

Clean the filter case before and after using the dryer.

Clean the inside of the product on a regular basis by asking an authorized service engineer.

Clean the Heat Exchanger with a soft brush or vacuum cleaner once a month, Do not touch the heat exchanger with your hand, there is a danger it may cause an injury.

The interior of the dryer should be cleaned periodically by qualified service personnel.

## Care for preventing freezing

- Install the dryer in an area where the temperature does not drop below zero degree Celsius.
- If draining directly using a long drain hose, the water remaining inside the hose can freeze in winter. Make sure there is no water left inside the hose after every use.
- If the drain hose has frozen up, wrap the hose with a towel soaked in warm water for approximately ten minutes to thaw it.

# Safety information

## Instructions about the WEEE



### Correct Disposal of This Product (Waste Electrical & Electronic Equipment)

(Applicable in countries with separate collection systems)

This marking on the product, accessories or literature indicates that the product and its electronic accessories (e.g. charger, headset, USB cable) should not be disposed of with other household waste at the end of their working life. To prevent possible harm to the environment or human health from uncontrolled waste disposal, please separate these items from other types of waste and recycle them responsibly to promote the sustainable reuse of material resources.

Household users should contact either the retailer where they purchased this product, or their local government office, for details of where and how they can take these items for environmentally safe recycling.

Business users should contact their supplier and check the terms and conditions of the purchase contract. This product and its electronic accessories should not be mixed with other commercial wastes for disposal.

For information on Samsung's environmental commitments and product regulatory obligations, e.g. REACH, WEEE or Batteries, visit our sustainability page available via [www.samsung.com](http://www.samsung.com)

# Installation

## What's included

Carefully unpack the dryer. Keep all packaging materials away from children. The parts and location of parts shown below may differ from your dryer. Before installation, make sure the dryer has all the parts listed here. If the dryer and/or parts are damaged or missing, contact the nearest Samsung customer service center.

## Dryer at a glance

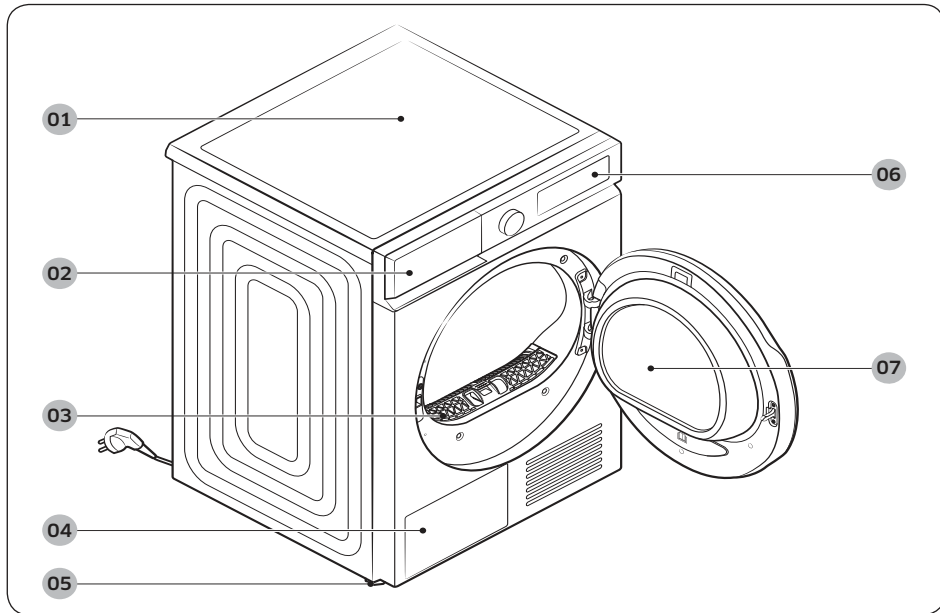

01 Top cover

03 Lint filter

05 Levelling leg

07 Door

02 Water tank

04 Heat exchanger

06 Control panel

# Installation

## Accessories (supplied)

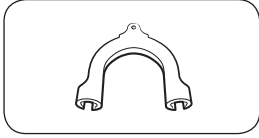

Hose guide

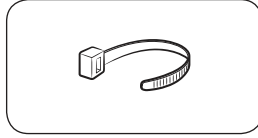

Cable tie

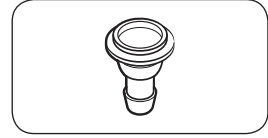

Hose connector

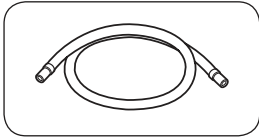

Long drain hose (2 m)

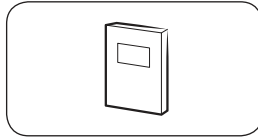

User manual

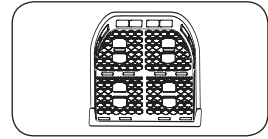

Drying rack (applicable models only)

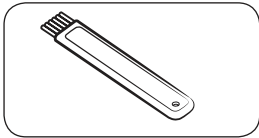

Cleaning brush

## Accessories (not supplied)

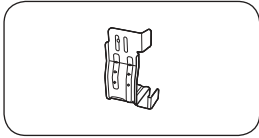

Stacking kit bracket  
(Part # SK-DH; SK-DA; SKK-DF)

### NOTE

- The stacking kit allows the dryer to be stacked on top of a washer. Please note that the stacking kit can only be used with Samsung washers and dryers. To purchase a stacking kit above, contact a Samsung service centre or local appliance retailer. The stacking kit differs with the washer model.
- For stacking instructions with the dryer, see the installation manual included in the stacking kit.
- For information on which stacking kit model you can use to stack your dryer on the washing machine, see the user manual included in your Samsung washing machine.

## Installation requirements

### NOTE

This dryer must be installed by a qualified installer. If service is required due to poor or faulty installation, it is considered the owner's responsibility and may void the warranty. Keep these instructions for future reference.

### WARNING

- Do not plug the power cord into a wall outlet before the dryer is completely installed.
- Have two or more persons help move the dryer.
- Do not let children or pets play in, on, or around the dryer. Proper supervision is necessary at all times.
- Keep all packaging materials away from children.
- Do not replace a damaged power cord or power plug yourself. Have Samsung or a qualified service technician replace a damaged power cord or power plug.
- Do not attempt to repair, disassemble, or modify the dryer. For any repairs, contact the nearest Samsung service center.
- Remove the door/lids from all discarded appliances to avoid children from suffocating.
- If the dryer generates a strange noise, burning smells, or smoke, unplug the power plug immediately and contact the nearest Samsung service center.
- Do not unplug the dryer while it is operating.
- Do not place flammable objects near the dryer.

### Electrical and grounding requirements

- The dryer must be properly grounded. If the dryer malfunctions or breaks down, grounding reduces the risk of electric shock by providing a path of least resistance for the electric current. The dryer comes with a power cord that has a 3-prong grounding plug. The plug must be plugged into an appropriate outlet that is properly installed and grounded in accordance with all local codes and ordinances.
- If you have any questions regarding the electrical or grounding requirements, please contact Samsung or a qualified electrician.

### WARNING

- Plug the power cord into a grounded, 3-prong outlet.
- Do not use a damaged power plug, cord, or loose or damaged wall outlet.
- Do not use an adapter or an extension cord.
- Improper connection of the equipment-grounding conductor may result in electric shock. If you are unsure if the dryer is properly grounded, check with a qualified electrician.
- Do not modify the power plug, power cord, or power outlet in any way.
- Do not connect the ground wire to plastic plumbing lines, gas lines, or hot water pipes.

# Installation

## Alcove or closet installation

For alcove or closet installation, the dryer requires the following minimum clearances:

| Sides | Top   | Front  | Rear  |
|-------|-------|--------|-------|
| 25 mm | 25 mm | 490 mm | 50 mm |

If installing the dryer with a washing machine, the front of the alcove or closet must have an unobstructed air opening of at least 550 mm. Minimum size of installation space: 3.9m<sup>3</sup>

## Step-by-step installation

Before you install your dryer, make sure you have read **Installation requirements** on page 17.

### STEP 1 Select a location

#### Location requirements

Select a level, well-constructed surface that will withstand vibrations. Select a location where a grounded, 3-prong outlet is easily accessible.

For convenience, consider installing the dryer next to your washing machine.

#### WARNING

- Install the dryer indoors only.
- Do not install the dryer in areas exposed to the weather.
- The ambient temperature for installation is 5~35°C.
  - If the ambient temperature is low enough to freeze the condensed water in the dryer and hoses, the dryer may not operate, or can be damaged.
  - Make sure that the temperature where the dryer is installed is not outside the recommended temperature range. Drying performance may be reduced.
  - Make sure not to install the dryer in an enclosed environment or near any heat producing appliances.
- Do not install the dryer where gas may leak.
- Do not use in a poorly ventilated space or area.
- Use only a power source connected to the wall.

## STEP 2 Adjust the levelling feet

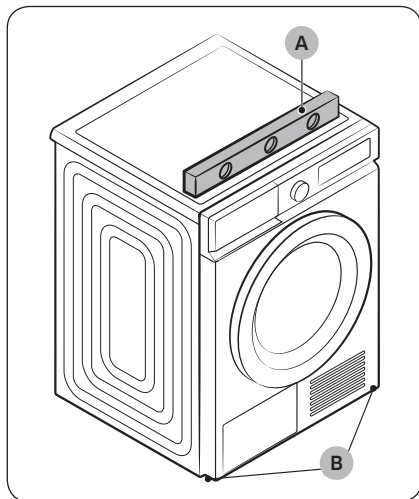

1. Gently slide the dryer into the desired location.
2. Use a **level (A)** and check the levelness of the dryer from side to side and front to back.
3. If the dryer is not level, turn the **levelling feet (B)** left or right to adjust the height.
4. Once the dryer is level, make sure the dryer stands firmly on the floor.
5. Plug in the dryer.

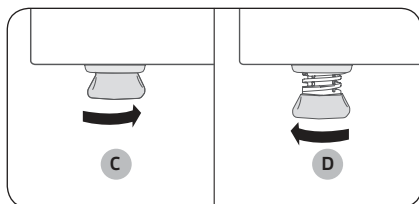

### NOTE

- To set the dryer to the same height as the washing machine, turn the levelling feet to the right until it fully **retracts (C)**. Then, turn the levelling feet to the left to **extend (D)** it until the dryer and the washing machine are the same height.
- Extend the levelling leg only as much as necessary. Extending the levelling leg more than necessary can cause the dryer to vibrate.

# Installation

## STEP 3 Connect the drain hose

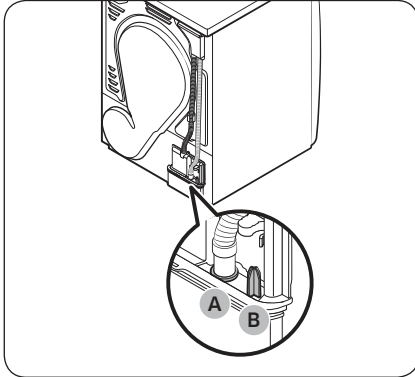

- We strongly recommend connecting the drain hose to your drainage system.
- If the drain hose connected on the dryer is too short to reach the drainage system, use the provided accessory hose (long drain hose).
- Use the built-in water tank only if you cannot connect the drain hose to a drainage system.

### NOTE

As a factory default, this dryer is set to use the built-in water tank to drain condensed water.

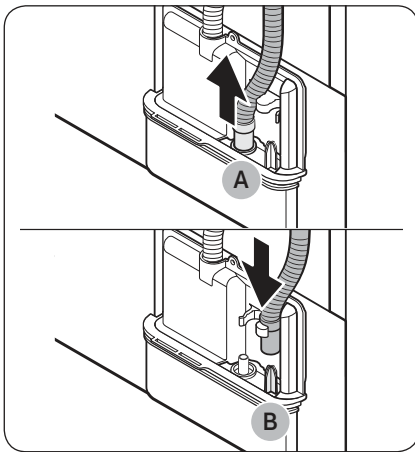

1. Remove the drain hose from **hole (A)**, and insert it into **part (B)**.

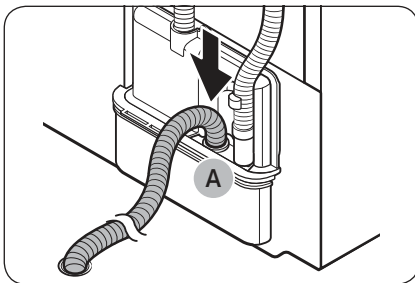

2. Insert one end of the accessory hose (long drain hose) into **hole (A)**.
3. Insert the other end (outlet) of the accessory hose to the drainage system in one of the following ways:

### Over a wash basin:

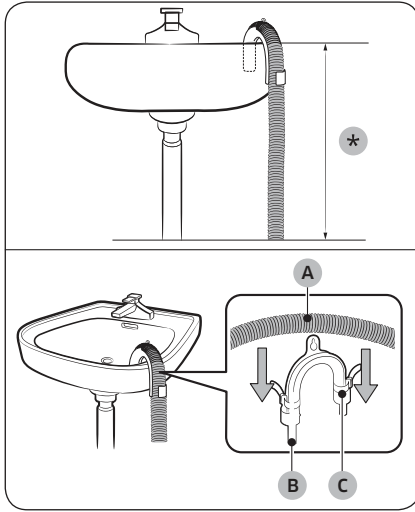

1. Make sure to place the end of the accessory hose lower than **90 cm (\*)** from the bottom of dryer.
2. To bend some point of the accessory hose, use the supplied plastic **hose guide (B)** and secure the guide to the wall with a hook or to the tap with a piece of string. Assemble the **drain hose (A)** and the **hose guide (B)** and fix them with the  **cable-tie (C)**.
3. You can drain the condensed water by connecting the accessory hose (long drain hose) to the drainoutlet directly.

#### ⚠ CAUTION

Do not extend the drain hose. Water may leak from the connected area. Use a long drain hose.

### By using the drain pipe of the wash basin:

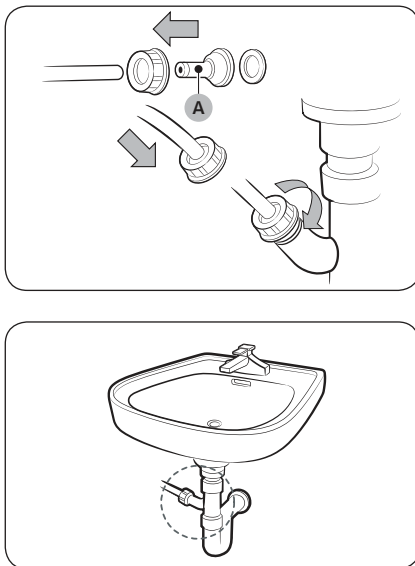

1. Assemble the **hose connector (A)**, and attach it to the end of the accessory hose as shown.

#### ⚠ CAUTION

To prevent water leak, make sure to connect the hose and the connector firmly.

2. Connect the hose adapter directly to the drain pipe of the wash basin.

# Installation

## STEP 4 Check the installation

- All packaging material is completely removed and properly disposed.
- The dryer is level and standing firmly on the floor.
- Make sure no accessory remains inside the drum.
- Do not block the air inlet hole of the cooling grill at the front of the dryer.
- Do not place inflammable objects near the dryer and keep the surroundings clean.
- Do not remove the adjustable levelling legs of the dryer. They are necessary to keep the dryer level with the ground.
- After installation, we recommend that you wait at least 1 hour before using the dryer.

## STEP 5 Power on

Plug the power cord into a wall socket protected by a fuse or circuit breaker. Then, tap  to turn on the dryer.

### NOTE

Run the Time Dry cycle for 20 minutes to make sure that it runs, heats, and shuts off. If the **HC** information code is displayed, contact a local service center.

## Door reversal

You might want to reverse the direction of the door, depending on your site conditions or to your needs.

### WARNING

Make sure door reversal is performed by a qualified technician.

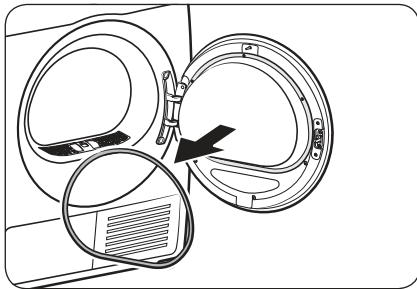

1. Remove the door packing from the door.

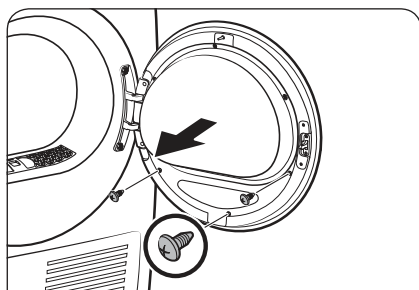

2. Remove the screws on the inner glass holder of the door.
- First, loosen and remove the 3 screws on the bottom. Then, loosen and remove the 3 screws on the top of the holder.

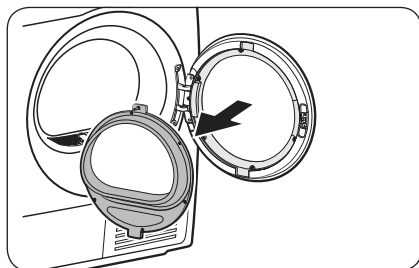
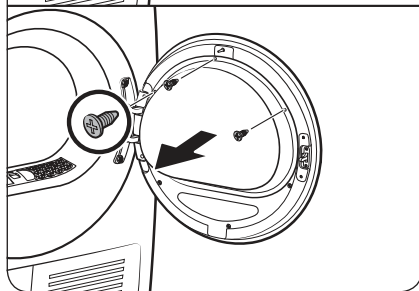

3. Detach the glass holder.

**⚠ CAUTION**

Use caution not to drop any part of the holder when detaching it. Property damage (cracks or breaks) or physical injury may occur.

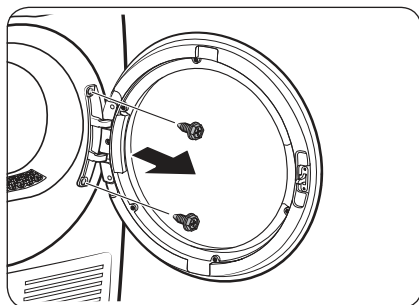

4. Remove the hinge screws, and then detach the door.
- Loosen and remove the 2 bolts on the door frame.
  - To prevent abrasion on the bolts, use a hex screwdriver.

# Installation

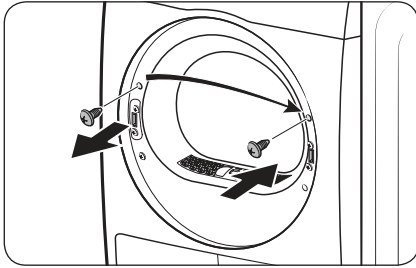

5. Remove the upper screw on the left of the door frame, and then insert it in the corresponding right hole of the door frame. Do not remove the lower bracket screws.

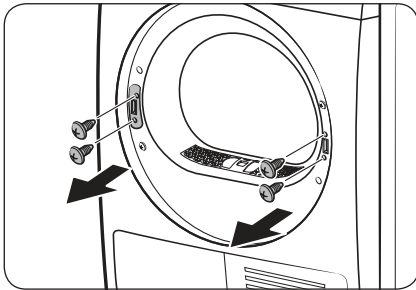

6. Remove the 2 bracket screws on the right frame, and then remove the 2 holder screws on the left frame.

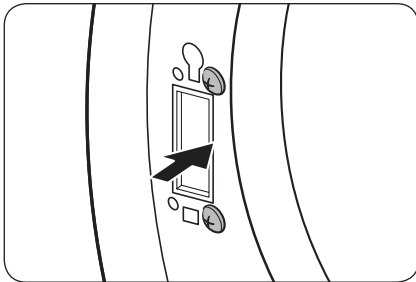

7. Insert the 2 removed bracket screws in the left frame as shown.  
- See the figure on the right for the correct position of the screws.

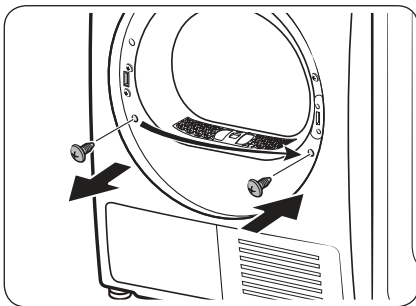

8. Remove the bottom screw on the left frame, and then insert it in the corresponding hole on the right frame.

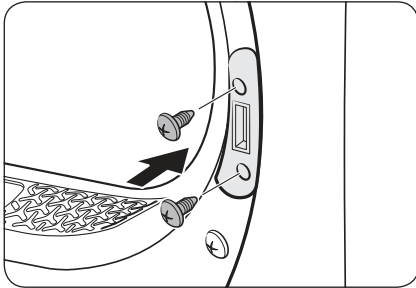

9. Insert the lever holder on the right frame, and then tighten the 2 holder screws.

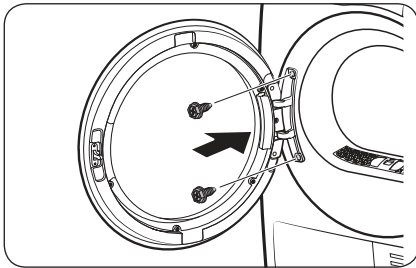

10. Insert the door hinge in the opposite position of the door frame, and then, tighten the 2 bolt screws.

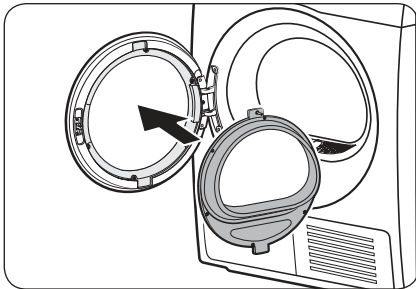

11. Insert the inner glass holder in the door cover that has been installed on the left frame.

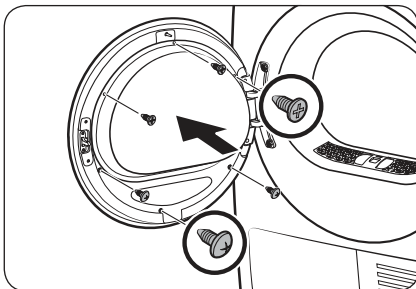

12. Tighten the 3 holder screws on the top. Then, tighten the 3 holder screws on the bottom.

# Installation

---

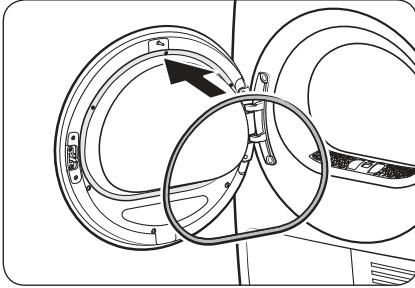

13. Attach the door packing to the door.

## NOTE

To return the door to the initial position, follow the steps again. Please note that the door, hinges, and other parts would be in the opposite orientation as listed in these steps.

## Environment



---

Please dispose of the packaging materials for this product in an “environmentally friendly” manner. For further detail, please contact your local area authority.

# Before you start

## Initial setup

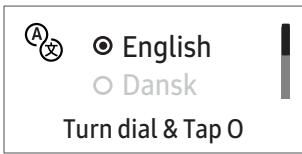
- When you turn on your dryer for the first time, the screen shows the initial setup process. Follow the onscreen instructions to complete it.
- If you complete the initial setup and operate a cycle for more than a minute, the initial setup will not appear again.
- The initial setup includes language selection and a brief tutorial.
- When tapping a button, tap exactly over the icon.
- Operating the washing machine and dryer at the same time may result in a loss of power depending on where they are installed and your electrical power status.

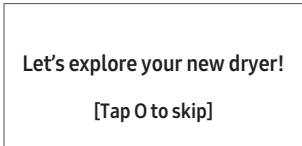
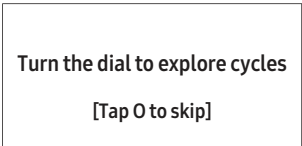
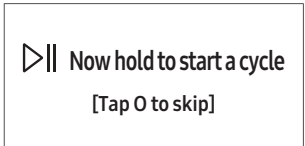
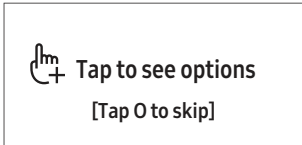
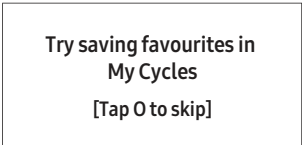
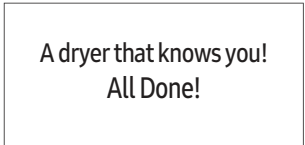
|   |  |   |
|---|--|---|
| <p><b>01</b> Language selection</p>  | <p><b>02</b> Welcome screen</p>  |   |
| <p><b>03</b> Tutorial</p>   |  |   |
|                                      |                                   |   |
|                                     |                                  |  |

# Before you start

---

## Drying guidelines

---

### STEP 1 Sort

---

- Do not mix heavy and lightweight items together.
- Wash and dry dark-colored items separately from light-colored items.
- Unless recommended on the care label, do not dry woolens or fiberglass items.
- Do not dry items soiled with oil, alcohol, gasoline, etc.
- Avoid drying unwashed items
- Do not dry wet items that have not been fully spin-dried after washing. This could cause an odor inside the dryer or cause the dryer to malfunction.
- Using a laundry net is recommended for baby socks and other small, light items.

### STEP 2 Empty pockets and turn them inside out

---

- Turn dark-colored clothes inside out before drying them. This will prevent fabric damage due to friction during the drying process and protect internal parts of the dryer from discoloration and damage.
- Turn the items with buttons or embroideries inside out before drying them.

#### CAUTION

- Empty the pockets. Metallic objects such as coins, pins, and buckles on clothing may damage other laundry items as well as the drum.
- Remove any metallic objects attached to items, pull up zippers, and latch hooks before drying. Metallic objects attached to items may damage other items as well as the drum.

### STEP 3 Check the lint filter

---

Ensure that the lint filter is installed correctly before putting items in the dryer. The dryer does not work without the lint filter.

- Always clean the lint filter before drying. For more information on filter cleaning, see the “**Lint filter**” section on page **44**.

---

## STEP 4 Determine the load capacity

---

Do not overload the dryer. Overloading reduces the tumbling action, resulting in uneven drying and wrinkling.

- Put one wash load in the dryer at a time.
- To improve drying efficiency for one or two items, add a dry towel to the load.
- For best results, untangle items before inserting them into the dryer. Tangled items may degrade the drying efficiency or cause the door to open.

### CAUTION

Add or remove items into or from the dryer with the lint filter installed. If the filter is not in place, small items can fall into the filter slot and cause the dryer to malfunction.

---

## STEP 5 After finishing the drying







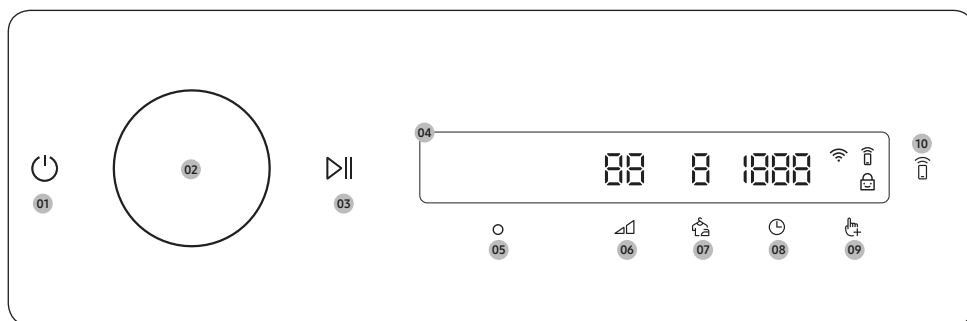

---



- Empty the water tank to prevent leaks. For more information on emptying the water tank, see the “Emptying the water tank” section on page 43.
- If the “Clean heat exchanger” message appears on the display, refer to the “Heat exchanger” section on page 46 and clean the heat exchanger.
- Keep the dryer door and the heat exchanger cover open after finishing the drying to keep the inside of the dryer more hygienic.

# Operations



## Control panel



|   |  |
|---|--|
| <p>01 Power </p>             | <p>Tap to turn the dryer on or off.</p> <ul style="list-style-type: none"> <li>If you do not manipulate the control panel for 10 minutes after the dryer is turned on, the dryer automatically turns off.</li> <li>The dryer automatically turns off when the drying completes.</li> </ul> <p><b>CAUTION</b></p> <p>Do not tap  to turn the dryer off while the drying is in progress. Tap and hold  to pause the cycle first, and then tap  to turn the dryer off.</p> |
| <p>02 Navigation dial</p>   | <p>Turn the <b>Navigation dial</b> left or right to navigate through cycles and functions. When you turn the <b>Navigation dial</b>, the display shows your selection (such as cycle, additional functions, and system functions).</p>   |
| <p>03 Start/Pause </p>       | <p>Tap and hold to start or pause an operation.</p>  |
| <p>04 Display</p>   | <p>The display shows the current cycle, estimated time remaining, cycle options, and other useful or alert messages.</p>   |
| <p>05 OK </p>              | <p>Tap to confirm your selection of function or setting.</p>   |
| <p>06 Dry Level </p>       | <p>Tap to change the dry level for the selected cycle. You can select from level 1 to 3, but available level depends on the selected cycle.</p> <ul style="list-style-type: none"> <li><b>3:</b> Suitable for large and thick items.</li> <li><b>2:</b> Standard drying level.</li> <li><b>1:</b> Gently dries items to protect fabric. Suitable for delicate items or items you want to naturally dry (by hanging or laying flat on drying rack) while they are damp.</li> </ul>  |
| <p>07 Wrinkle Prevent </p> | <p>Tap to turn the Wrinkle Prevent function on or off. When the function is on, the dryer rotates the drum intermittently after completing the dry cycle to prevent wrinkles.</p>  |

|  |  |
|--|--|
| 08 Time           | Tap to select the cycle time for Warm Air, Cool Air, or Time Dry. You can set the drying time between 20 minutes and 240 minutes. Available drying time depend on the selected cycle.  |
| 09 Options        | <ul style="list-style-type: none"> <li>• Tap to enter the Options menu.</li> <li>• Tap and hold for 3 seconds to enter the Settings menu.</li> </ul>   |
| 10 Smart Control  | <p>Tap to activate or deactivate the Smart Control function.</p> <ul style="list-style-type: none"> <li>• When the Smart Control function is activated, you can control your dryer remotely using the SmartThings app in your smartphone.</li> </ul> |

#### Icon description

|   |               |  |
|---|---------------|--|
|  | Wi-Fi         | This icon indicates that the dryer is connected to Wi-Fi.  |
|  | Smart Control | This icon indicates that Smart Control is on. For more information on “ <b>Smart Control</b> ”, see page 39. |
|  | Child Lock    | This icon indicates that Child Lock is on. For more information on “ <b>Child Lock</b> ”, see page 36.       |

# Operations

## Operating a cycle

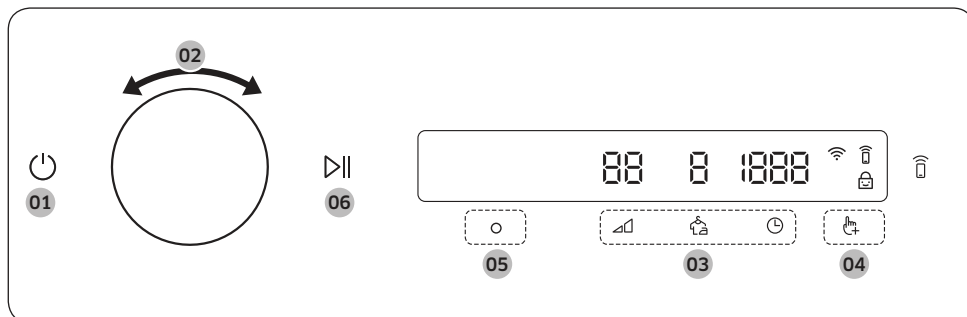

1. Tap to turn on the dryer.
2. Turn the **Navigation dial** to select the cycle you want. For more information on “**Cycle overview**”, see page 33.
3. Tap , , or to change the default cycle settings.
4. Tap , and then turn the **Navigation dial** to select additional function. For more information on “**Options**”, see page 35.
5. Tap to change the settings for selected additional function. Not all cycles have additional functions available.
6. Tap and hold to start operation. Once you set the cycle you want, the screen displays a brief cycle description, maximum laundry load, and cycle time. You can also check the cycle progress, remaining cycle time, and information codes.

## Cycle overview

### NOTE







Other cycles can be used after adding them to your cycle list using the My Cycles function. For more information, see the “My Cycles” section on page 36.

### Sensor Dry cycles

| Cycle  | Description   | Max load (kg) |
|--|---|---------------|
|  Cotton | For cottons, bed linen, table linen, underwear, towels, and shirts.   | 9.0           |
| Mixed Load   | For mixed loads consisting of cotton and synthetic fabrics.   | 9.0           |
| Synthetics   | For blouses, and shirts that are made of polyester (Diolen, Trevira), polyamide (Perlon, nylon), or other similar blends.   | 4.0           |
| Delicates  | For the delicate items to be handled with care such as lingerie.  | 2.0           |
| Towels   | Use to dry loads such as bath towels.   | 4.0           |
| Bedding  | For bulky items such as blankets, sheets, comforters, and light duvets.   | 2.0           |
| Shirts   | Use to quickly dry one item such as a shirt.  | 2.0           |
| Wool   | For machine washable and tumble dryable wool only.<br>For best results, turn laundry inside out before drying.  | 1.0           |
| Outdoor  | For outdoor wear such as skiwear and mountain clothing, and also for fabrics such as spandex, stretch, and microfiber. It is recommended to use this cycle after you have washed your laundry using the <b>Outdoor</b> with your washing machine. | 2.0           |
| Iron Dry   | This cycle finishes the drying process in a moist state, which facilitates ironing.   | 9.0           |

# Operations

## Manual Dry cycles

| Cycle         | Description  | Max load (kg) |
|---------------|--|---------------|
| Quick Dry 35' | For drying light cotton synthetics or items that needs quick drying.<br>The default dry time is 35 minutes.  | 1.0           |
| Time Dry      | Use to set a desired dry time.<br>Turn the <b>Navigation dial</b> to select <b>Time Dry</b> and tap  to set the drying time between 20 minutes and 240 minutes. Tap  repeatedly to select the available time options in this order: 20 / 30 / 40 / 50 / 60 / 90 / 120 / 150 / 180 / 240.<br> <b>NOTE</b> <ul style="list-style-type: none"> <li>The actual cycle time may differ depending on the dryness of items.</li> <li>If you use this cycle for additional drying after finishing one of the Sensor Dry cycles (listed on page 33), set the minimum drying time (20 minutes). Excessive drying may cause damage or deform to an item.</li> </ul> | -             |
| Warm Air      | For small, pre-dried items.<br>Timed cycle for all types of fabric except for wool and silk.<br>Dry laundry that is still slightly damp or has already been pre-dried.<br>Also suitable for the subsequent drying of multi-layered, thick laundry that does not dry readily.<br>Turn <b>Navigation dial</b> to select <b>Warm Air</b> and tap to set the drying time between 20 minutes and 240 minutes. Tap  repeatedly to select the available time options in this order: 20 / 30 / 40 / 50 / 60 / 90 / 120 / 150 / 180 / 240.   | -             |
| Cool Air      | All types of fabric. For freshening up or airing items of laundry that have not been worn for long.<br>Turn <b>Navigation dial</b> to select <b>Cool Air</b> and tap  to set the drying time between 20 minutes and 240 minutes. Tap  repeatedly to select the available time options in this order: 20 / 30 / 40 / 50 / 60 / 90 / 120 / 150 / 180 / 240.  | -             |



## Air Wash cycles

| Cycle        | Description   | Max load (kg) |
|--------------|---|---------------|
| Hygiene Care | For sanitizing wet and dry clothes and linen fabric to eliminate bacteria.  | 2.0           |
| Air Refresh  | Use this cycle to disinfect clothes and make them feel fresher and cleaner. | 1.0           |

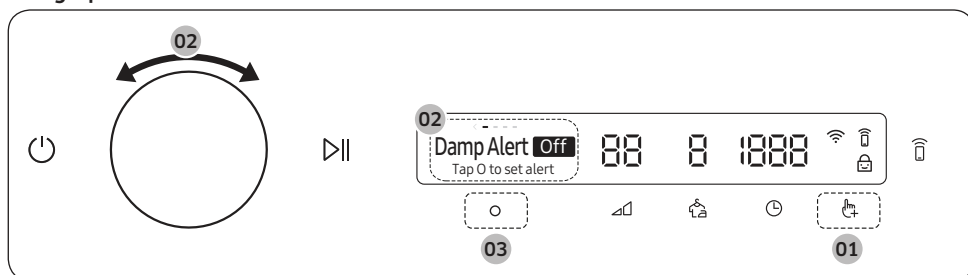

## Options

### Using Options







1. Tap .
2. Turn the **Navigation dial** to select the desired additional function.
3. Tap  to change the selected function's settings or start the function.

#### NOTE

- To return to the main screen, tap  again or turn the **Navigation dial** to select **Back** and tap .
- If the selected function is not supported, the "**Currently not supported**" message is displayed, and the  button is not activated.
- When you select an additional function, a brief help message appears for the first ten times of use.
- If you do not manipulate the control panel for 7 seconds after entering the Options menu, the display returns to the main screen.

### Damp Alert





This function alerts you when shirts and other items that require ironing are dry enough to be suitable for ironing.

1. Select a cycle and change the cycle settings as necessary.
  - This function is available for Cotton, Synthetics, and Mixed Load with the Dry Level  set to 2 or 3.
2. Tap .
3. Turn the **Navigation dial** to select **Damp Alert**, and then tap .
4. Tap and hold .

# Operations

## My Cycles



Add or remove cycles to create a personal cycle list.





1. Tap .
2. Turn the **Navigation dial** to select **My Cycles**, and then tap .
  - You can only edit a cycle to create a personal cycle when the dryer is not operating.
3. Turn the **Navigation dial** to select a desired cycle.
4. Tap  to add or remove the selected cycle.
  - Addition and removal of a cycle is saved automatically.
5. Once you finish creating My Cycles, tap  to return to the cycles screen.

### NOTE



The Cotton, Synthetics, and Iron Dry cycles cannot be removed from the cycles list.

## Child Lock

To prevent children or infants from accidentally starting or setting the dryer, **Child Lock** locks all buttons except for  and .



1. Close the door.
2. Tap .
3. Turn the **Navigation dial** to select **Child Lock**, and then tap .
4. Tap  to select **On** or **Off**.
  - The **Child Lock**  icon turns on when the function is on.
  - You cannot turn on Child Lock with the door open. If you get the “**Door is open**” message on the display while you try to turn on Child Lock, close the door and try again.

### NOTE

- When Child Lock is on, all buttons are disabled except for  and .
- If you tap a button with Child Lock on, an alarm triggers with the “**Child Lock on**” message.
- If you open and close the door with Child Lock on, an alarm triggers with the “**Open door & check inside**” and “**Child Lock on**” message.
- To dismiss a notification message, turn off Child Lock or the power.

## Drum Light

This turns on the light inside the drum so you can check the status of the items inside.



1. Tap .
2. Turn the **Navigation dial** to select **Drum Light**, and then tap .
  - Even if the dryer is turned off, the drum light will turn on as long as the power cable is connected.
  - Once the Drum Light function is enabled, the drum light will turn off automatically after 2 minutes.
  - Opening the dryer door automatically turns on the drum light. The light will then turn off automatically after 2 minutes.

## System functions

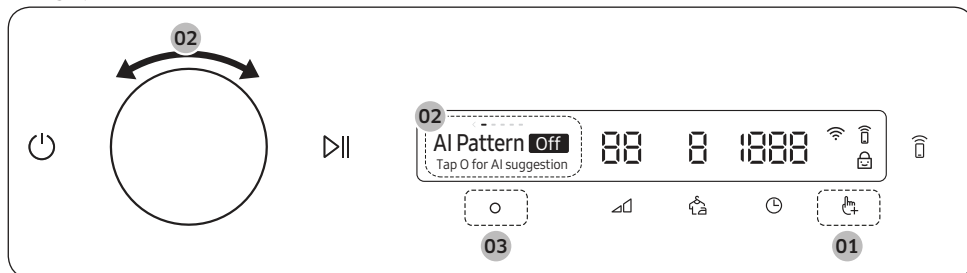

### Using System Functions



\* Tap and hold 3 seconds.





1. Tap and hold  for 3 seconds.
2. Turn the **Navigation dial** and select the desired system function, and then tap .
3. Tap  to change the selected function's settings or start the function.

#### NOTE

- To return to the main screen, tap  again or turn the **Navigation dial** to select **Back** and tap .
- If you do not manipulate the control panel for 7 seconds after entering the System Functions menu, the display returns to the main screen.



### AI Pattern

This function saves your frequently used cycles and settings.

1. Tap and hold  for 3 seconds.
2. Turn the **Navigation dial** to select **AI Pattern**, and then tap .
3. Tap  to select **On** or **Off**.
  - The default setting is **On**. Set it to **Off** if you do not want to use this function.
  - When you turn the function on, the dryer remembers frequently used cycles and their settings (Dry Level , Time ) and save them in frequently used order.
  - When you turn off the function, all the saved data resets.

### Sound

You can turn on or off the sound from the dryer.

1. Tap and hold  for 3 seconds.
2. Turn the **Navigation dial** to select **Sound**, and then tap .
3. Tap  to select **On** or **Off**.
  - The default setting is **On**.

#### NOTE





The setting remains unchanged even if you restart the dryer.

# Operations

---



## Wi-Fi

You can turn the dryer's Wi-Fi on or off.

1. Tap and hold  for 3 seconds.
2. Turn the **Navigation dial** to select **Wi-Fi**, and then tap .
3. Tap  to select **On** or **Off**.
  - The dryer's Wi-Fi is off as a factory default setting. However, the dryer's Wi-Fi turns on automatically when you turn on the dryer for the first time. Then, the final Wi-Fi setting maintains regardless of the dryer power status.
  - Once you turn on the dryer's Wi-Fi and connect to a network, the dryer remains connected to the network even when you turn off the power.
  - The Wi-Fi  indicates that the dryer is connected to the router through the Wi-Fi connection.



## Language

You can change the system language.

1. Tap and hold  for 3 seconds.
2. Turn the **Navigation dial** to select **Language**, and then tap .
3. Turn the **Navigation dial** to select the desired language, and then tap .

## Factory Reset

You can reset your dryer.



1. Tap and hold  for 3 seconds.
2. Turn the **Navigation dial** to select **Factory Reset**, and then tap .
  - Your dryer resets to the factory setting.

## Special features



### Smart Control

You can connect to the SmartThings app and control your dryer remotely.

#### Connecting your dryer



- Download and open the SmartThings app on your mobile device
- Tap and hold  to turn on the dryer.
- Tap and hold  on the dryer.
  - a. The dryer enters AP mode and connects to your mobile device.
  - b. Tap  to authenticate your dryer on your mobile device.
  - c. Once the authentication process is complete, your dryer is successfully connected to the app. Use various features available in the SmartThings app.

#### NOTE

- If your dryer fails to connect with the SmartThings app, try again.
- Check your router if you experience any Internet connection problem after connecting your dryer with the SmartThings app.
- If the Wi-Fi is off, tap and hold  for 3 seconds to navigate to **System Functions**, select **Wi-Fi** and tap  to turn it on.
- Turning the dryer's Wi-Fi on allows you connect to the dryer via SmartThings app on your smartphone regardless of the power status of the dryer. However, the dryer appears offline on the SmartThings app if the dryer's Wi-Fi is off.
- Close the door before starting the Smart Control function.
- If you use the dryer 20 times without being connected to SmartThings, the next time you turn the dryer on, a pop-up about Smart Control connection will appear for 3 seconds.
- If the dryer's Wi-Fi is not connected to an AP (access point), the Wi-Fi will turn off when you turn of the power.

### Stay Connect

Set up the Stay Connect function in your SmartThings app. Your dryer stays connected to the app so you can use the dryer when you are away from home.

1. If you turn on the Stay Connect function on the SmartThings app, the dryer will stay in standby power saving mode after completing a cycle.
  - The Stay Connect function will remain active for up to 24 hours if the door remains closed.
2. When the Stay Connect function is active, the Smart Control  and Wi-Fi  turn on your dryer display.
3. Conveniently control your dryer using the SmartThings app.

#### NOTE

The dryer switches to standby power saving mode when operation is paused even if the machine is not connected to the SmartThings app.

# Operations

## SmartThings

### Wi-Fi connection

On your smartphone, go to **Settings** and turn on the wireless connection and select an AP (Access Point).

- This appliance supports the Wi-Fi 2.4 GHz protocols.

### Download

On an app market (Google Play Store, Apple App Store, Samsung Galaxy Apps), find the SmartThings app with a search term of “SmartThings”. Download and install the app on your device.

#### NOTE

The app is subject to change without notice for improved performance.

In addition, the further updates on app or the function in the app may stop due to usability and security reasons, even if updates are currently supported on your OS.

### Log in

You must first log into SmartThings with your Samsung account. To create a new Samsung account, follow the instructions on the app. You don't need a separate app to create your account.

#### NOTE

If you have a Samsung account, use the account to log in. A registered Samsung smartphone user automatically logs in.

### To register your appliance to SmartThings

1. Make sure your smartphone is connected to a wireless network. If not, go to **Settings** and turn on the wireless connection and select an AP (Access Point).
2. Open **SmartThings** on your smartphone.
3. If a message of “A new device is found.”, select **Add**.
4. If no message appears, select **+** and select your appliance in a list of devices available. If your appliance is not listed, select **Device Type > Specific Device Model**, and then add your appliance manually.
5. Register your appliance to the SmartThings app as follows.
  - a. Add your appliance to SmartThings. Make sure your appliance is connected to SmartThings.
  - b. When registration is complete, your appliance appears on your smartphone.

## Open Source Announcement

The software included in this product contains open source software. You may obtain the complete corresponding source code for a period of three years after the last shipment of this product by contacting our support team via <http://opensource.samsung.com> (Please use the "Inquiry" menu.)

It is also possible to obtain the complete corresponding source code in a physical medium such as a CD-ROM; a minimal charge will be required.

The following URL [http://opensource.samsung.com/opensource/SMART\\_AT\\_051/seq/0](http://opensource.samsung.com/opensource/SMART_AT_051/seq/0) leads to the open source license information as related to this product. This offer is valid to anyone in receipt of this information.



### NOTE

Hereby, Samsung declares that this radio equipment is in compliance with Directive 2014/53/EU and with the relevant statutory requirements in the UK. The full text of the EU declaration of conformity and the UK declaration of conformity is available at the following internet address: The official Declaration of conformity may be found at <http://www.samsung.com>, go to Support > Support home and enter the model name.

Wi-Fi max transmitter power : 20 dBm at 2.412 GHz – 2.472 GHz

# Operations

## Using the drying rack (applicable models only)

Set the drying time up to 150 minutes according to the moisture and weight of the items to dry. When drying laundry using the drying rack, the Time Dry cycle is recommended.

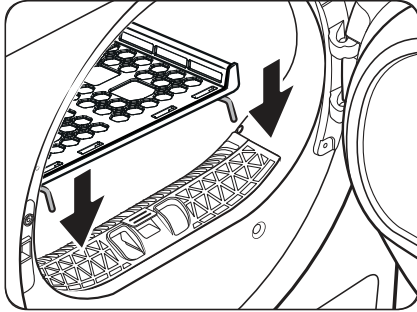

1. Position the drying rack in the drum, inserting the front lips of the rack into the holes of the door diaphragm.

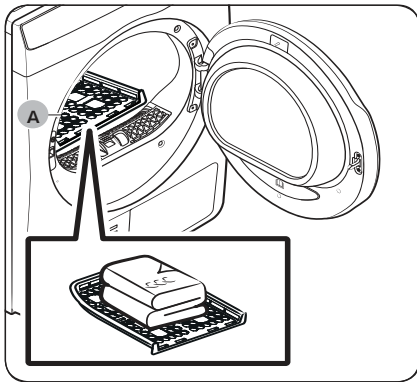

2. Place items on the rack, leaving enough space where air can circulate. For clothing items, fold and place flat on the rack.
3. Close the door and tap . Turn the **Navigation dial** to select **Time Dry**, and then tap to select the drying time.
4. Tap and hold .

A. Drying rack

## Drying suggestions

| Items (max 1.5 kg)                                      | Description  |
|---|--|
| Washable sweaters (block to shape and lay flat on rack) | When drying the laundry using the rack, fold and place the clothes on the rack to prevent the clothing from becoming wrinkled. |
| Stuffed toys (cotton or polyester fiber filled)         |  |

### CAUTION

- Drying foam rubber, plastic, or rubber on a heat setting may cause damage to the items and lead to a fire hazard.

# Maintenance

## Emptying the water tank

Empty the water tank after each use to prevent leaks.

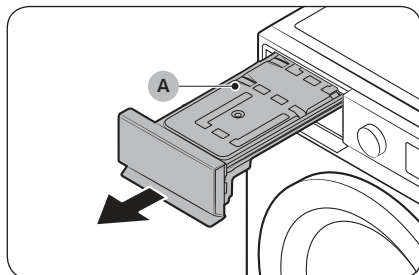

1. Remove the **water tank (A)** from the dryer.
  - Pull the water tank handle with one hand until the tank is halfway out.
  - Once the water tank is halfway out, support the bottom of the tank with the other hand and pull it slowly with both hands.

### ⚠ CAUTION

- The water tank is heavy. Slowly remove the water tank using both hands while keeping the tank at a level.
  - Be careful when removing the full water tank. It is very heavy and can cause injury if you drop it.
2. Empty the water through the **drain hole (B)**, and then clean inside the water tank.
    - Mix some neutral detergent in lukewarm water. Fill the water tank with the mixture through the **drain hole (B)** and leave it for 30 minutes. Then, rinse the tank with clean water and completely dry it.
  3. Place the water tank back into place.

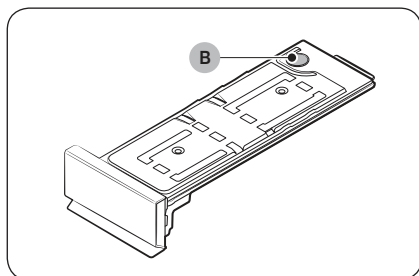

### 📖 NOTE

If the dryer displays the “**Empty the tank**” message and stops while drying is in progress, empty the water tank and tap and hold ▷||. The “**Empty the tank**” message will disappear, and the dryer will resume drying.

# Maintenance

## Cleaning

### ⚠ WARNING

- Do not clean the dryer by directly spraying water onto the dryer.
- Do not clean the dryer with benzene, thinner, alcohol, or acetone. This may cause discoloration, deformation, damage, electric shock, or fire.
- Before cleaning the dryer, be sure to unplug the power cord.

### Exterior

Clean with a soft, damp cloth. Do not use abrasive cleaners. Avoid using or placing sharp or heavy objects near/on the dryer. Keep detergent and laundry supplies on the pedestal (sold separately) or in a separate storage container.

### Control panel

Clean with a soft, damp cloth. Do not use abrasive cleaners. Do not spray cleaners directly on the panel. Immediately wipe up any spills or liquids from the control panel.

### Drum

Clean with a damp cloth with a mild, non-abrasive cleaner suitable for stainless steel. Wipe remaining residue with a clean, dry cloth.

### Door

Foreign substances can contaminate or build up on the inside of the door. Clean the inside of the door using a soft piece of cloth or brush.

### ⚠ CAUTION

Do not detach the door's rubber sealing.

### Lint filter

Clean the lint filter after each use.

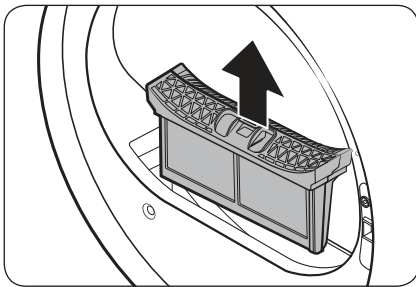

1. Open the dryer door, grab the top of the lint filter, and pull to remove the filter.
  - Do not detach the rubber sealing after removing the filter.

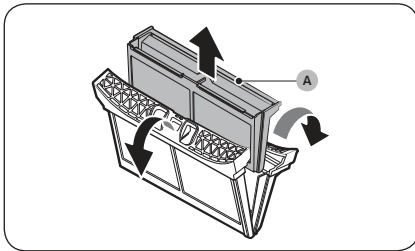

2. Open the outer filter and remove the **inner filter (A)**.

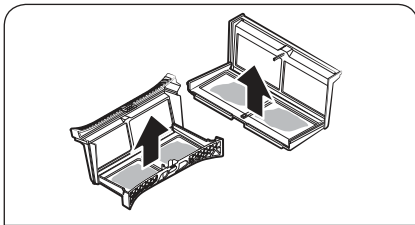

3. Spread open the outer filter and the inner filter.

4. Remove the lint from both filters, and then clean the filters with the cleaning brush.

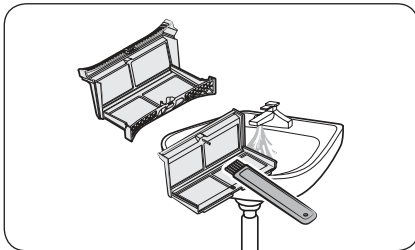
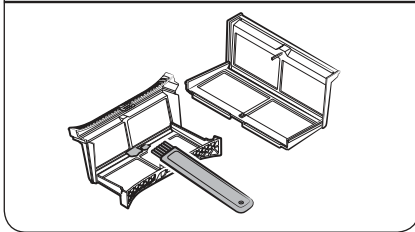

**NOTE**

To clean the filters thoroughly, clean the filters in running water, and then dry them completely.

# Maintenance

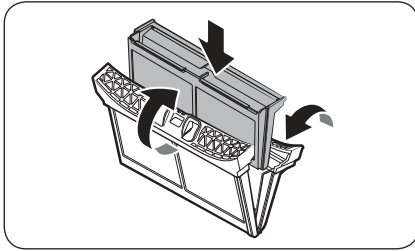

- Put the inner filter into the outer filter, and then reinsert the lint filter into the original position.

## ⚠ CAUTION

- Clean the lint filter after each load. Otherwise, the drying performance may decrease.
- If the filter surface is wet, allow it to completely dry before use.
  - Inserting the filter while it is wet can cause mold and/or odor to form and/or result in less drying.
- When cleaning or removing the lint filter, do not shake or tap on the filter. Doing so can damage the filter.
- Opening the outer and inner filters carelessly and with excessive force can damage the filters.

## Heat exchanger

When it is time to clean the heat exchanger, the dryer will alert you by displaying the “**Clean heat exchanger**” message.

A dirty heat exchanger will hinder the product’s performance and should be cleaned regularly.

## 📖 NOTE

- Water droplets can form around the heat exchanger due to condensation caused by a temperature difference. This is normal and is not a sign of a leak.
- If you are not planning on using the dryer for a long period of time, open the heat exchanger cover and ventilate.

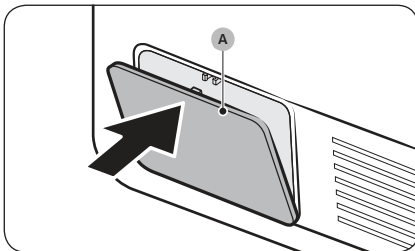

- Gently press the top part of the **outer cover (A)** to open.

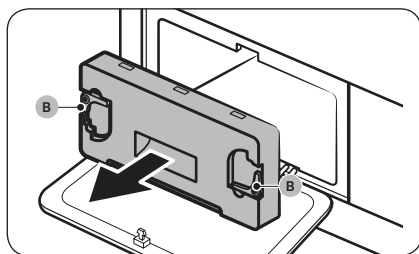

2. Unlock the inner cover **fixers (B)**, and then pull the inner cover to remove.
  - A small amount of leaked refrigerant may remain around the heat exchanger. Before cleaning, open the heat exchanger cover and ventilate for about 10 minutes.

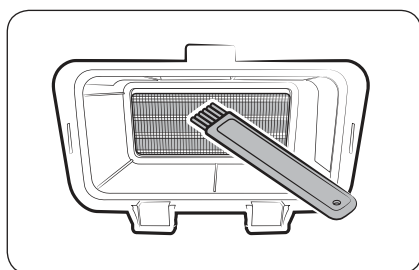

3. Clean the dust on the heat exchanger using the provided brush.
  - After cleaning with the brush, wipe off the remaining dust using a smooth, damp cloth.

**⚠ CAUTION**

- To avoid physical injury and burns, do not touch or clean the heat exchanger with bare hands and steel tools.
- When cleaning the heat exchanger, be careful not to damage the fins.

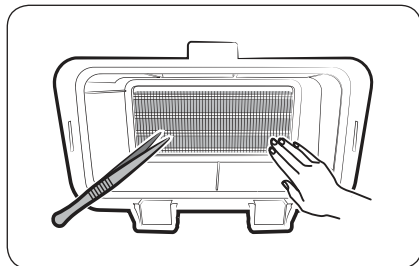

**📖 NOTE**

If the heat exchanger is completely dry and therefore hard to clean, spray some water on the heat exchanger and clean using a brush.

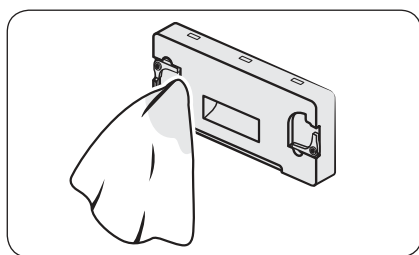

4. Clean the inner cover with a smooth, damp cloth.
  - There may be moisture and/or foreign substances around the inner cover.

# Maintenance

---

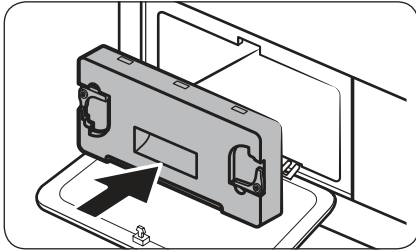

5. Reinsert the inner cover to its original position, and then lock the fixers.
6. Close the heat exchanger's outer cover.

## NOTE

- After cleaning the heat exchanger, tap  to dismiss the notification message. The message remains on until you dismiss it.
- If the alarm continues after you have dismissed it, unplug and then plug in the power cord or remove and reinsert the heat exchanger's inner cover.

# Troubleshooting

## Checkpoints

If you encounter a problem with the dryer, first check the table below and try the suggestions.

| Problem                                 | Action   |
|---|--|
| Dryer does not start.                   | <ul style="list-style-type: none"> <li>• Make sure the dryer is plugged in.</li> <li>• Make sure the door is properly closed.</li> <li>• Check the fuse or reset the circuit breaker.</li> <li>• If you opened the door during a cycle, tap and hold ▷   again.</li> <li>• Clean the filter.</li> <li>• Make sure Child Lock is not activated.</li> </ul>  |
| The dryer does not warm up.             | <ul style="list-style-type: none"> <li>• Check the fuse or reset the circuit breaker.</li> <li>• Check the lint filter and the heat exchanger. Clean them if necessary.</li> <li>• The dryer may be in the cooling down process of the cycle.</li> </ul>   |
| Items are not dried.                    | <p>Check all of the above. Additionally:</p> <ul style="list-style-type: none"> <li>• Do not overload the dryer. If the dryer is overloaded, it could take longer for items to dry.</li> <li>• Dry heavy fabrics separately from light fabrics.</li> <li>• The item(s) are too small and may not getting enough spinning inside the drum.</li> <li>• Clean the filter.</li> <li>• Clean the heat exchanger.</li> <li>• If a drain hose is connected, make sure water is draining properly.</li> </ul>  |
| The dryer is too loud.                  | <ul style="list-style-type: none"> <li>• Look for coins, loose buttons, nails, and other objects and remove them immediately.</li> <li>• Check the lint filter. Remove any items stuck inside the lint filter.</li> <li>• Make sure the dryer is level and standing firmly on the floor.</li> <li>• The dryer may hum due to air moving through the drum and fan. This is normal.</li> </ul>   |
| Items are not dried evenly.             | <ul style="list-style-type: none"> <li>• Seams, pockets, and other parts of clothing are harder to dry than others. This is normal.</li> <li>• Sort heavy and light items separately.</li> </ul>   |
| There is a smell coming from the dryer. | <ul style="list-style-type: none"> <li>• The smell of paint, varnish, cleaning agents, and other household items could have circulated in the air and entered the dryer. If you notice such a smell, ventilate completely before using the dryer.</li> <li>• If drying in an enclosed area, the dryer could cause the ambient temperature to rise. Accordingly, make sure to open a window and ventilate the area.</li> <li>• Do not attempt to dry wet items after leaving them in the washing machine or dryer for a long time.</li> </ul> |

# Troubleshooting

| Problem   | Action  |
|---|---|
| The dryer turns off before the items are dry.                                   | <ul style="list-style-type: none"> <li>The load is too small. Throw in few additional items like towels and try drying again.</li> </ul>  |
| The clothes have lint on them.  | <ul style="list-style-type: none"> <li>Always make sure the lint filter is clean before putting items into the dryer. When drying items that generate a large amount of lint, you may need to clean the lint filter in the middle of a cycle.</li> <li>Some fabrics (such as white towels) causes more lint and should be dried separately from fabrics that lint attaches easily (such as black linen pants).</li> <li>Check the inside of the pockets to make sure they are empty before drying.</li> </ul> |
| The ambient temperature around the dryer rises or there is a damp, soggy smell. | <ul style="list-style-type: none"> <li>Heat pump dryers circulate ambient air inside and outside the dryer during the drying process to cool the system. Using the dryer in a poorly ventilated area may, depending on the operating environment, raise the ambient humidity level and/or cause a damp, soggy smell to develop. Ensure proper ventilation when using the dryer.</li> </ul>  |
| Water is not draining.  | <ul style="list-style-type: none"> <li>Check the draining hose for twists and kinks. Straighten out the hose if it is twisted or kinked and securely connect it to the drain on the floor.</li> <li>Check to see if the draining hose is frozen. If the hose is frozen, submerge it in warm water to allow the water inside the hose to melt and drain out. Reconnect the hose and check for proper draining.</li> </ul>  |

If a problem persists, contact a local Samsung service center.

## Information codes

If the dryer fails to operate, you may see an information code on the screen. Check the table below and try the suggestions.

| Information code                         | Meaning  | Action   |
|--|--|--|
| Door is open                             | Dryer operation with the door open   | <ul style="list-style-type: none"> <li>• Close the door and start again.</li> <li>• If this continues, call for service.</li> <li>• Check if Child Lock is on. If Child Lock is on, you may get this message when you open the door even though the dryer is not operating.</li> </ul>   |
| Open door & check inside (Child Lock on) | Child Lock is on. Open the door and check inside the drum.                                   | <ul style="list-style-type: none"> <li>• If Child Lock is on, turn off Child Lock or the power.</li> </ul>   |
| Check filter                             | Lint filter problem  | <ul style="list-style-type: none"> <li>• Check the lint filter assembly.</li> <li>• If this continues, call for service.</li> </ul>  |
| Check inner cover of heat exchanger      | Internal heat exchanger cover problem  | <ul style="list-style-type: none"> <li>• Check the internal heat exchanger cover assembly.</li> <li>• If this continues, call for service.</li> </ul>  |
| Check drainage / Empty the tank          | Draining malfunction<br>Draining pump malfunction<br>Frozen draining hose<br>Water tank full | <ul style="list-style-type: none"> <li>• Make sure the draining hose is not bent or damaged.</li> <li>• If the hose is frozen, wrap the hose with a towel soaked in warm water for approximately ten minutes to thaw the hose.</li> <li>• Empty the water tank, turn on the dryer, and start again.</li> <li>• If this continues, call for service.</li> </ul> |
| tC                                       | Air temperature sensor problem   | <ul style="list-style-type: none"> <li>• Clean the lint filter or the heat exchanger.</li> <li>• If this continues, call for service.</li> </ul>   |
| tC5                                      | Compressor temperature sensor problem  | <ul style="list-style-type: none"> <li>• Wait two to three minutes.</li> <li>• Turn the power back on and start again.</li> </ul>  |
| tC7                                      | Check the Eva In temperature sensor  | <ul style="list-style-type: none"> <li>• Turn the power back on and start again.</li> <li>• If this continues, call for service.</li> </ul>  |
| 3C                                       | Check the motor for operation.   | <ul style="list-style-type: none"> <li>• Try restarting the cycle.</li> <li>• If this continues, call for service.</li> </ul>  |

# Troubleshooting

| Information code | Meaning  | Action  |
|------------------|--|---|
| AC6              | Check communications between the main and the inverter PBAs. | <ul style="list-style-type: none"><li>• Try restarting the cycle.</li><li>• If this continues, call for service.</li></ul>                                    |
| HC               | Compressor overheating                                       | <ul style="list-style-type: none"><li>• If this continues, call for service.</li></ul> Please check the cleaning condition of heat exchanger and lint filter. |
| HCL              | There is a refrigerant leak.                                 | <ul style="list-style-type: none"><li>• Call for service.</li></ul> Not available use the dryer until service engineer visits except power On/OFF.            |

If any information code keeps appearing on the screen, contact a local Samsung service center.

# Appendix

## Fabric care chart

The following symbols provide garment care direction. The Clothing care labels include symbols for drying, bleaching, drying and ironing, or dry cleaning when necessary. The use of symbols ensures consistency among garment manufacturers of domestic and imported items. Follow care label directions to maximize garment life and reduce laundering problems.

### Washing

|  |  |
|--|--|
|  | 95 °C boil wash.                                 |
|  | 60 °C coloured wash.                             |
|  | 60 °C coloured wash. ("Easy care" coloured wash) |
|  | 40 °C coloured wash.                             |
|  | 40 °C mild wash.                                 |
|  | 40 °C very mild wash.                            |
|  | 30 °C fine wash.                                 |
|  | 30 °C mild fine wash.                            |
|  | 30 °C very mild fine wash.                       |
|  | Hand wash.                                       |
|  | Do not wash.                                     |

### NOTE

The numbers in the wash tub specify the maximum washing temperatures in degrees celsius which must not be exceeded.

### Bleaching

|  |                             |
|--|-----------------------------|
|  | Any bleach allowed.         |
|  | Only oxygen bleach allowed. |
|  | Do not bleach.              |

### Drying





|  |  |
|--|--|
|  | Tumble drying / Drying at a temperature of 80 °C with a normal drying process. |
|  | Tumble drying / Drying at a temperature of 60 °C with a mild drying process.   |
|  | Do not tumble dry  |
|  | Line drying.   |
|  | Drip line drying.  |
|  | Flat drying.   |
|  | Drip flat drying.  |
|  | Line drying in the shade.  |
|  | Drip line drying in the shade.   |
|  | Flat drying in the shade.  |
|  | Drip flat drying in the shade.   |

### NOTE

- The dots indicate the drying level of the dryer.
- The lines indicate the type and place of the drying.

# Appendix

## Ironing



|   |   |
|---|---|
|  | Iron at maximum sole plate temperature of 200 °C.   |
|  | Iron at maximum sole plate temperature of 150 °C.   |
|  | Iron at maximum sole plate temperature of 110 °C.<br>Caution when using steam irons (work without steam). |
|  | Do not iron.  |









### NOTE

The dots indicate the temperature ranges for ironing (regulator, steam, travel irons and ironing machines).

## Professional care

|   |  |
|---|--|
|  | Professional dry-cleaning in perchloroethylene and/or hydrocarbons (heavy benzines) with normal process. |
|  | Professional dry-cleaning in perchloroethylene and/or hydrocarbons (heavy benzines) with gentle process. |

|   |   |
|---|---|
|  | Professional dry-cleaning in hydrocarbons (heavy benzines) with normal process. |
|  | Professional dry-cleaning in hydrocarbons (heavy benzines) with gentle process. |
|  | Do not dry-clean.   |
|  | Professional wet-cleaning.  |
|  | Mild professional wet-cleaning.   |
|  | Very mild professional wet-cleaning.  |
|  | Do not wet-clean.   |



### NOTE

- The letters in a circle indicate the solvents (P, F) used in dry cleaning or wet cleaning (W).
- Generally, the line under the symbol indicates a milder treatment (e.g. gentle cycle for easy-care items). The double line indicates care levels with particularly gentle treatment.

## Protecting the environment

- This appliance is manufactured from recyclable materials. If you decide to dispose of this appliance, please observe local waste disposal regulations. Cut off the power cord so that the appliance cannot be connected to a power source. Remove the door so that animals and small children cannot get trapped inside the appliance.
- Refrigerant (Type): R290  
Refrigerant (Charging) : 0.149 kg

## Specification

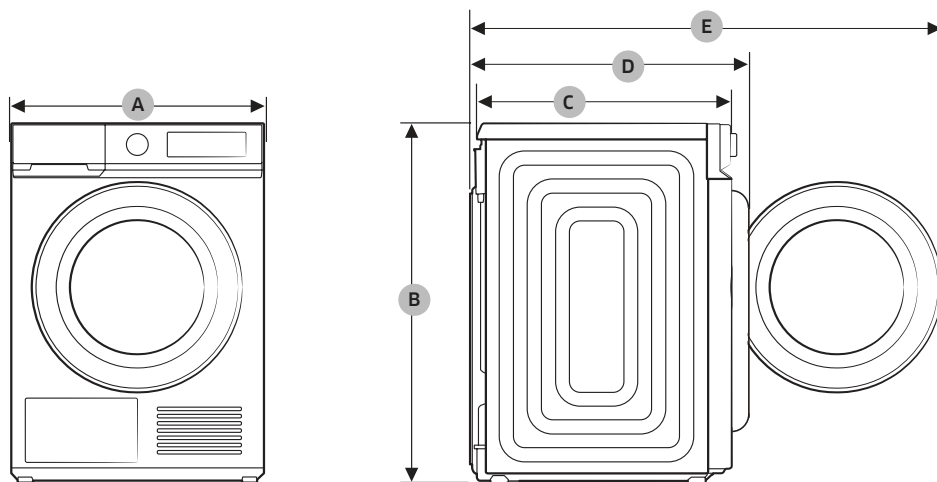

| TYPE                    |                      | FRONT LOADING DRYER |
|-------------------------|----------------------|---------------------|
| MODEL NAME              |                      | DV9*BB5245**        |
| DIMENSIONS              | A                    | 600 mm              |
|                         | B                    | 850 mm              |
|                         | C                    | 600 mm              |
|                         | D                    | 650 mm              |
|                         | E                    | 1100 mm             |
| WEIGHT                  |                      | 50.0 kg             |
| ELECTRICAL REQUIREMENTS | AC 220–240 V / 50 Hz | 750 W               |
| ALLOWABLE TEMPERATURE   |                      | 5-35 °C             |

# Appendix

## Consumption data

| Model        | Program   | Load (kg) <sup>(1)</sup> | Energy (kWh) | Max. Duration (Minutes) |
|--------------|---|--------------------------|--------------|-------------------------|
| DV9*BB5245** |  COTTON <sup>(2)</sup> | 9.0                      | 1.58         | 182                     |
|              |   | 4.5                      | 0.87         | 128                     |
|              | IRON DRY <sup>(2)</sup>   | 9.0                      | 1.00         | 110                     |
|              | SYNTHETICS  | 4.0                      | 0.69         | 70                      |

<sup>(1)</sup> : Weight of dry laundry

<sup>(2)</sup> : EN 61121:2013 test program

All data without a "star" against it was calculated using EN 61121:2013

Consumption data can vary from the nominal values given above depending in the size of the load, types of textiles, residual moisture levels after spinning, fluctuations in the electricity supply and any extra options selected.

## Specification sheet

In accordance with applicable energy labelling regulations.

### NOTE

“ \* ” Asterisk(s) means variant model and can be varied (0-9) or (A-Z).

| Samsung  |                |  |
|--|----------------|--|
| Model Name   |                | DV9*BB5245**   |
| Capacity   | kg             | 9.0  |
| Type   |                | Condenser  |
| Energy Efficiency  |                |  |
| A+++ (highest efficiency) to D (least efficient)   |                | A+++   |
| Energy Consumption   |                |  |
| Annual Energy Consumption (AE_C) (Energy consumption is based on 160 drying cycles of the standard cotton programme at full and partial load, and the consumption of the low-power modes. Actual energy consumption per cycle will depend on how the appliance is used.)   | kWh/yr         | 192.0  |
| Automatic tumble drier   | kWh            | Yes  |
| Energy consumption (E_dry) standard cotton programme at full load  | kWh            | 1.58   |
| Energy consumption (E_dry.1/2) standard cotton programme at partial load   | kWh            | 0.87   |
| off mode and left-on mode  |                |  |
| The power consumption off-mode (P_o) at full load  | W              | 0.50   |
| The power consumption in left-on mode (P_l) at full load   | W              | 5.00   |
| Duration of the left-on mode   | min            | 10   |
| Programme to which the information on the label and the Sheet relate ('standard cotton programme' used at full and partial load is the standard drying programme to which the information in the label and the fiche relates. This programme is suitable for drying normal wet cotton laundry and it is the most efficient programme in terms of energy consumption for cotton. Consumption data can vary from the nominal values given above depending on the size of the load, types of textiles, residual moisture levels after spinning, fluctuations in the electricity supply and any extra options selected.) |                |  Cotton + Dry Level 2 + (Wrinkle Prevent off) |
| programme duration of the standard program   |                |  |
| Weighted Programme time standard cotton programme at full load and partial load  | min            | 151  |
| Programme Time (T_dry) standard cotton programme at full load  | min            | 182  |
| Programme Time (T_dry.1/2) standard cotton programme at partial load   | min            | 128  |
| condensation efficiency class  |                |  |
| A (most efficient) to G (least efficient)  |                | B  |
| Average condensation efficiency at full load   | %              | 86   |
| Average condensation efficiency at partial load  | %              | 86   |
| Weighted condensation efficiency   | %              | 86   |
| Airborne noise emissions   |                |  |
| Dry at full load   | dB (A) re 1 pW | 64   |

# Contact information

## QUESTIONS OR COMMENTS?

| COUNTRY         | CALL   | OR VISIT US ONLINE AT  |
|-----------------|--|--|
| UK              | 0333 000 0333  | <a href="http://www.samsung.com/uk/support">www.samsung.com/uk/support</a>   |
| IRELAND (EIRE)  | 0818 717100  | <a href="http://www.samsung.com/ie/support">www.samsung.com/ie/support</a>   |
| GERMANY         | 06196 77 555 77  | <a href="http://www.samsung.com/de/support">www.samsung.com/de/support</a>   |
| FRANCE          | 01 48 63 00 00   | <a href="http://www.samsung.com/fr/support">www.samsung.com/fr/support</a>   |
| SPAIN           | 91 175 00 15   | <a href="http://www.samsung.com/es/support">www.samsung.com/es/support</a>   |
| PORTUGAL        | 210 608 098<br>Chamada para a rede fixa nacional<br>Dias úteis das 9h às 20h | <a href="http://www.samsung.com/pt/support">www.samsung.com/pt/support</a>   |
| LUXEMBURG       | 261 03 710   | <a href="http://www.samsung.com/be_fr/support">www.samsung.com/be_fr/support</a>   |
| NETHERLANDS     | 088 90 90100   | <a href="http://www.samsung.com/nl/support">www.samsung.com/nl/support</a>   |
| BELGIUM         | 02-201-24-18   | <a href="http://www.samsung.com/be/support">www.samsung.com/be/support</a> (Dutch)<br><a href="http://www.samsung.com/be_fr/support">www.samsung.com/be_fr/support</a> (French)  |
| NORWAY          | 21629099   | <a href="http://www.samsung.com/no/support">www.samsung.com/no/support</a>   |
| DENMARK         | 707 019 70   | <a href="http://www.samsung.com/dk/support">www.samsung.com/dk/support</a>   |
| FINLAND         | 030-6227 515   | <a href="http://www.samsung.com/fi/support">www.samsung.com/fi/support</a>   |
| SWEDEN          | 0771-400 300   | <a href="http://www.samsung.com/se/support">www.samsung.com/se/support</a>   |
| AUSTRIA         | 0800 72 67 864 (0800-SAMSUNG)  | <a href="http://www.samsung.com/at/support">www.samsung.com/at/support</a>   |
| SWITZERLAND     | 0800 726 786   | <a href="http://www.samsung.com/ch/support">www.samsung.com/ch/support</a> (German)<br><a href="http://www.samsung.com/ch_fr/support">www.samsung.com/ch_fr/support</a> (French) |
| HUNGARY         | 0680SAMSUNG (0680-726-7864)  | <a href="http://www.samsung.com/hu/support">www.samsung.com/hu/support</a>   |
| CZECH           | 800 - SAMSUNG (800-726786)   | <a href="http://www.samsung.com/cz/support">www.samsung.com/cz/support</a>   |
| SLOVAKIA        | 0800 - SAMSUNG (0800-726 786)  | <a href="http://www.samsung.com/sk/support">www.samsung.com/sk/support</a>   |
| CROATIA         | 072 726 786  | <a href="http://www.samsung.com/hr/support">www.samsung.com/hr/support</a>   |
| BOSNIA          | 055 233 999  | <a href="http://www.samsung.com/ba/support">www.samsung.com/ba/support</a>   |
| North Macedonia | 023 207 777  | <a href="http://www.samsung.com/mk/support">www.samsung.com/mk/support</a>   |
| MONTENEGRO      | 020 405 888  | <a href="http://www.samsung.com/support">www.samsung.com/support</a>   |
| SLOVENIA        | 080 697 267 (brezplačna številka)  | <a href="http://www.samsung.com/si/support">www.samsung.com/si/support</a>   |
| SERBIA          | 011 321 6899   | <a href="http://www.samsung.com/rs/support">www.samsung.com/rs/support</a>   |

| COUNTRY   | CALL   | OR VISIT US ONLINE AT   |
|-----------|--|---|
| Kosovo    | 038 40 30 90   | <a href="http://www.samsung.com/support">www.samsung.com/support</a>                |
| ALBANIA   | 045 620 202  | <a href="http://www.samsung.com/al/support">www.samsung.com/al/support</a>          |
| BULGARIA  | 0800 111 31 - Безплатен за всички оператори<br>*3000 - Цена на един градски разговор или според тарифата на мобилният оператор<br>09:00 до 18:00 - Понеделник до Петък | <a href="http://www.samsung.com/bg/support">www.samsung.com/bg/support</a>          |
| ROMANIA   | 0800872678 - Apel gratuit<br>*8000 - Apel tarifat în rețea   | <a href="http://www.samsung.com/ro/support">www.samsung.com/ro/support</a>          |
| ITALIA    | 800-SAMSUNG (800.7267864)  | <a href="http://www.samsung.com/it/support">www.samsung.com/it/support</a>          |
| CYPRUS    | 8009 4000 only from landline, toll free  | <a href="http://www.samsung.com/gr/support">www.samsung.com/gr/support</a>          |
| GREECE    | 80111-SAMSUNG (80111 726 7864) only from land line<br>(+30) 210 6897691 from mobile and land line  |   |
| POLAND    | 801-172-678* lub +48 22 607-93-33*<br>* (opłata według taryfy operatora)   | <a href="http://www.samsung.com/pl/support/">http://www.samsung.com/pl/support/</a> |
| LITHUANIA | 8-800-77777  | <a href="http://www.samsung.com/lt/support">www.samsung.com/lt/support</a>          |
| LATVIA    | 8000-7267  | <a href="http://www.samsung.com/lv/support">www.samsung.com/lv/support</a>          |
| ESTONIA   | 800-7267   | <a href="http://www.samsung.com/ee/support">www.samsung.com/ee/support</a>          |

**SAMSUNG**