

PRECAUTIONS

General safety instructions

Risk of personal injury

- According to current regulations, children between 3 and 8 years of age can take or load food from the appliance, but it is highly discouraged to allow children under 8 years of age to perform these operations and in general to use the appliance.
- Keep children under the age of eight at a safe distance unless they are constantly supervised and make sure that they do not play with the appliance.
- Never try to put out a fire or flames with water: turn off the appliance and smother the flames with a fire blanket.
- Do not touch the heating elements on the outside of the appliance.
- Cleaning and maintenance that should be performed by the user must not be carried out by unsupervised children.
- Do not modify this appliance.
- Do not insert pointed metal objects (cutlery or utensils) into the slots in the

appliance.

- Do not touch (especially with wet hands) frozen products or put them in your mouth directly.
- Do not store inflammable, explosive or volatile substances.
- Do not keep explosive substances, such as spray bottles with flammable propellants in the appliance.
- Bottles containing strong alcoholic drinks must be tightly closed and stored vertically.
- Organic compounds, acids and essential oils can corrode the seals and plastic surfaces if left in contact with them for extended periods.
- Turn off the appliance and unplug it from the mains before cleaning or maintenance.
- Do not pull the cable to unplug the appliance.

Risk of damaging the appliance

- Never rest sharp metal objects such as knives, forks, spoons and lids on the appliance during use.
- Do not use abrasive or corrosive detergents on

glass parts (e.g. scouring powders, stain removers and metallic sponges).

- Do not sit on the appliance.
- Do not sit or lean on the door or any open drawers.
- Do not use leverage on the door or handle to move the appliance.
- Do not use steam jets to clean the appliance.
- Do not use electrical devices (e.g. hair dryers) or sprays for defrosting, the plastic parts could be damaged.
- Do not use the appliance to cool rooms for any reason.
- Always unplug the appliance in the event of a fault or when performing cleaning or maintenance.
- Do not keep liquids in tins or glass containers in the freezer.
- Do not use sharp metal objects to remove excess ice build-up in the freezer compartment.
- Do not use adaptors for plugs.
- CAUTION: do not place portable multiple sockets or portable power supply units at the back of the appliance.
- Do not place heavy objects on the top of the appliance.
- Do not use sharp objects when removing ice and frost in order not to damage the appliance's walls.

Installation and maintenance

- The appliance must be connected to ground in compliance with electrical system safety standards.
- Position the appliance with the aid of a second person.
- Never use the open door to lever the appliance into place when fitting.
- Avoid exerting too much pressure on the door when open.
- The appliance must not be installed near heat sources. If this is not possible, suitable insulation must be used.
- The appliance must not be exposed to direct sunlight.
- Do not use the appliance outdoors.
- Installation and servicing should be carried out by qualified personnel in accordance with current standards.
- Have the electrical connection performed by authorised technical personnel.
- For avoiding dangers, if the power supply cable is damaged, contact technical support immediately and they will replace it, so as to prevent any risk.
- Always use any necessary/required personal protective equipment (PPE) before performing any work on the appliance

- (installation, maintenance, positioning or movement).
- Before performing any operation on the appliance, switch off the power supply.
- If installed near another refrigerator or freezer, keep it at a minimum distance of 2 cm.
- Do not try to repair the appliance yourself or without the assistance of a qualified technician.
- Do not install/use the appliance outdoors.
- CAUTION: while positioning the appliance, make sure that the power supply cable is not caught or damaged.
- To prevent instability of the appliance, install and secure it correctly as indicated in the instructions provided in this manual.
- This appliance can be used up to a maximum altitude of 2,000 metres above sea level.

For this appliance

- The appliance may only be used by children aged 8 years and over, and by people of reduced physical, sensory or mental capacity, or lacking in experience and knowledge in the use of the appliance, provided that they instructed on safe use of the appliance and the risks connected to it by adults who are responsible

- for their safety.
- Children must be supervised to ensure that they do not play with the appliance.
- Do not rest any weight or sit on the open door of the appliance.
- Take care that no objects are stuck in the doors.
- The appliance contains a small quantity of isobutane (R600a), make sure not to damage the cooling circuit during transport, installation and cleaning.
- Keep the ventilation openings surrounding the appliance or in the nearby area free from any obstructions.
- Do not use mechanical, electrical or chemical products other than those recommended by the manufacturer to speed up the defrosting process.
- Do not damage the cooling circuit (if it can be accessed).
- Do not use electrical appliances inside food storage compartments unless these are of the type recommended by the manufacturer.
- In the event of damage to the cooling circuit, avoid the use of naked flames and ventilate the area properly.
- Do not use the appliance or parts of it in ways other

than those specified in this manual.

- Caution: risk of fire, flammable materials.



- Opening the door for long periods can cause the temperature in the appliance compartments to rise considerably.
- Clean surfaces that may come into contact with food and accessible drainage systems regularly.
- Store raw meat and fish in suitable containers in the refrigerator, so that it does not come into contact with other food or drip on it.
- If the appliance is left empty for long periods of time, switch it off, thaw it, clean it, dry it and leave the door open to prevent the development of mould inside.

Appliance purpose

- This appliance is not intended to be used as a built-in appliance.
- The appliance is not designed for professional and commercial use.
- This appliance is for refrigeration and conservation of fresh and frozen foods in the home.

Every other use is considered improper.

- The appliance is designed for use in a domestic or similar environment, for instance:
 - Staff kitchen areas in shops, offices and other working environments;
 - farm houses and by guests in hotels, motels and other residential type environments;
 - bed and breakfast establishments;
 - catering and similar non-retail applications.
- The appliance is not designed to operate with external timers or with remote-control systems.



This appliance may only be installed and used indoors.

This user manual

- This user manual is an integral part of the appliance and must therefore be kept in its entirety and within the user's reach for the whole working life of the appliance.
- Read this user manual carefully before using the appliance.

Manufacturer's liability

The manufacturer declines all liability for damage to persons or property caused by:

- use of the appliance other than that specified;
- failure to comply with the instructions in the user manual;
- tampering with any part of the appliance;
- use of non-original spare parts.

Technical Support.

- In the event of failure of the appliance, contact the technical support and have the repair carried out by qualified

- personnel only.
- make sure you have the model and serial number available on the identification plate.
- Use original spare parts only.
- Do not try to repair the appliance yourself or without the assistance of a qualified technician: this affects safety and may void the warranty.
- Genuine spare parts for some specific components remain available for a minimum of 7 or 10 years, depending on the type of component, from the date the model is released on the market.

Identification plate

The identification plate bears the technical data, serial number and brand name of the appliance. Do not remove the identification plate for any reason.

Energy label

To be informed about the performance of your device via the EU EPREL database visit the following web address and enter the model name (available on the identification plate):

<https://eprel.ec.europa.eu>

On the energy label there is a QR code for a quick access to the web address. Use a device equipped with an appropriate reading program.

The energy label must be kept together with all documents supplied with the appliance.

Disposal

 This appliance conforms to the WEEE European directive (2012/19/EU) and must be disposed of separately from other waste at the end of its service life.

The appliance does not contain substances in quantities sufficient to be considered hazardous to health and the environment, in accordance with current European directives.

Power voltage Danger of electrocution

- Disconnect the mains power supply.
- Unplug the appliance.

To dispose of the appliance:

- Cut the power cable and remove it.
- Deliver the appliance to the appropriate recycling centre for electrical and electronic equipment waste, or return it to the retailer when purchasing an equivalent product, on a one for one

basis.

Our appliances are packaged in non-polluting and recyclable materials.

- Deliver the packing materials to the appropriate recycling centre.

Plastic packaging Danger of suffocation

- Do not leave the packaging or any part of it unattended.
- Do not let children play with the plastic bags.

Information for control bodies

- For EcoDesign checks, the installation and preparation of the appliance must comply with EN 62552 standard.
- Ventilation requirements, dimensions and minimum space from the rear wall are indicated in the "Installation" chapter of this manual.
- Contact the manufacturer for more information.

To save energy

- Correct use of the appliance, correct packaging of foodstuffs, a constant temperature and food hygiene have effects on the quality of storage.
- Reduce the number of times that the doors are opened and the length of time they remain open to prevent the compartments from heating up excessively.
- Clean the condenser (if it can be accessed) at the rear of the appliance periodically to prevent the appliance from losing efficiency.
- Defrost frozen food in the refrigerator compartment in order to make use of the cold stored in the frozen foods.
- Placing the shelves at different heights does not affect the stated energy consumption.

Light sources

- This appliance contains light sources which cannot be replaced by the user and must only be replaced by the technical assistance service.

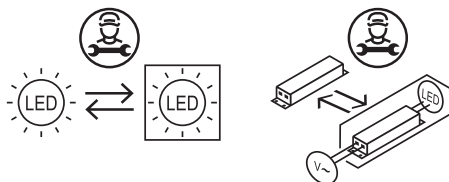

- This appliance contains light sources of efficiency class "G".

conventions:



Warning/ Caution



Information/ Advice

How to read the user manual

This user manual uses the following reading

DESCRIPTION

General Description

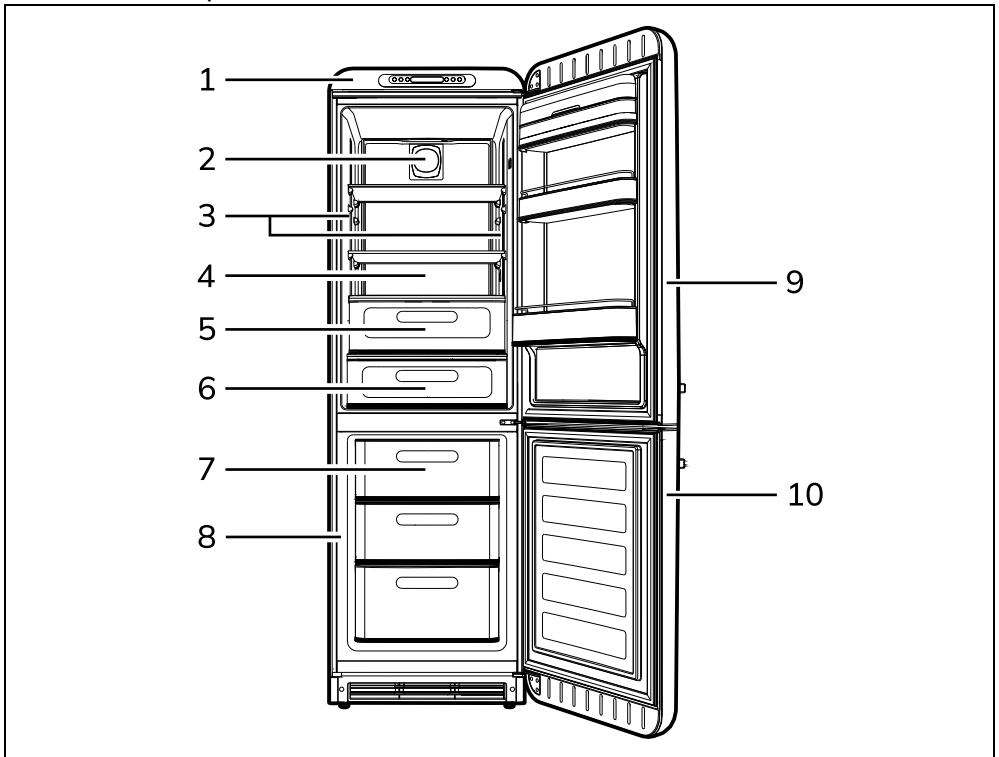

1 Control panel

For setting the temperature inside the refrigerator and freezer compartments.

2 Fan

Distributes the temperature and reduces condensation on the shelves and other surfaces.

3 Interior lighting

The interior of the appliance is lit when the door is opened.

4 Refrigerator compartment

For storing fresh foods.

5 Super-cold drawer

Useful to preserve the freshness and flavour of delicate foods such as meat and fish for longer.

6 Fruit and vegetable drawer

7 Quick freeze drawer

For quickly freezing fresh food.

8 Freezer compartment

For storing frozen foods, freezing fresh foods and producing ice cubes.

9 Fridge door

10 Freezer door

Control panel

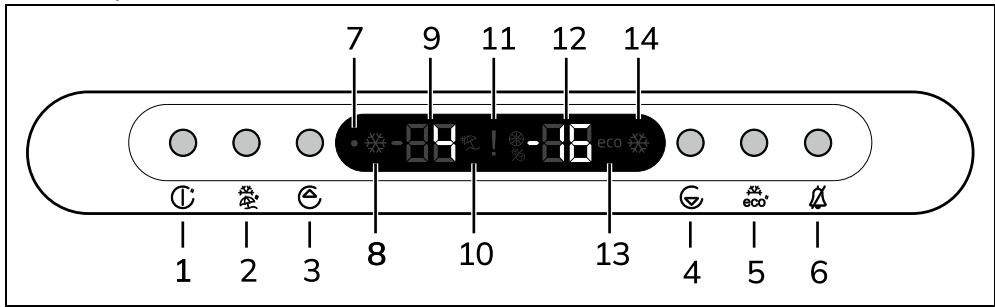

- 1 Turning ON/OFF the appliance
- 2 Refrigerator compartment super-cold function ON/OFF button; Vacation function (long press)
- 3 Refrigerator compartment temperature setting button
- 4 Freezer compartment temperature setting button
- 5 Freezer compartment super-cold function ON/OFF button; "ECO" function (long press)
- 6 Alarm deactivation button.
- 7 Appliance off indicator.
- 8 Refrigerator compartment super-cold function indicator.
- 9 Refrigerator compartment temperature display.
- 10 Vacation function indicator.
- 11 Alarm warning indicator.
- 12 Freezer compartment temperature display.
- 13 "Eco" function ON/OFF indicator.
- 14 Freezer compartment super-cold function indicator.

Shelves

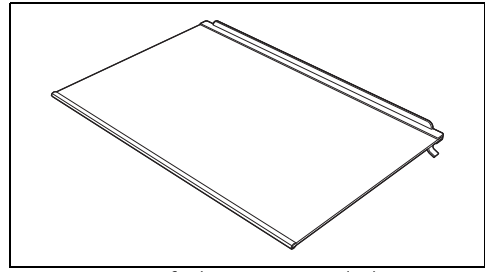

For optimising fridge space and placing foodstuffs inside the refrigerator compartment.

Fruit and vegetable drawer

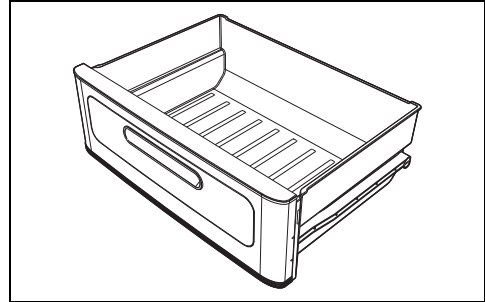

For storing fruit and vegetables, maintaining a constant humidity level.

Super-cold drawer

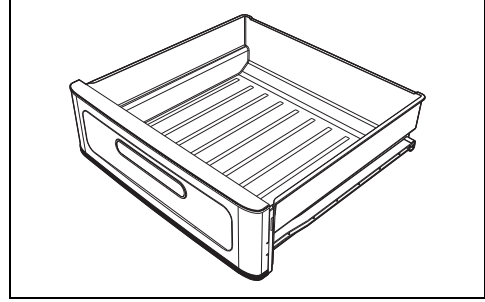

Can be used for maintaining freshness and

Accessories

 Not all accessories are available on some models.

 The accessories intended to come into contact with food are made of materials that comply with the provisions of current legislation.

 Original supplied and optional accessories can be requested to Authorised Assistance Centres. Use only original accessories supplied by the manufacturer.

flavour of delicate food such as meat, fish and lightly frozen foods for a longer time period, since temperature is kept constantly between -2°C and $+3^{\circ}\text{C}$.



Do not place food to be frozen or trays to make ice in the refrigerator compartment.

Freezer drawers

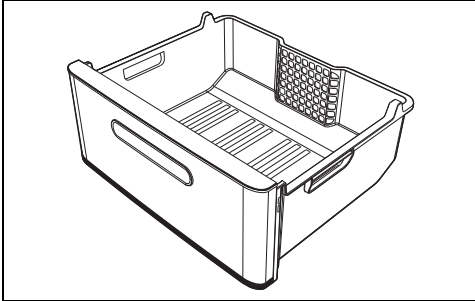

For storing frozen or deep-frozen food.

USE

Preliminary operations



See General safety instructions.

- Remove any protective film from the outside or inside of the appliance, including accessories.
- Remove any labels (apart from the technical data plate) from the accessories and shelves.
- Remove and wash all the appliance accessories (see chapter "CLEANING AND MAINTENANCE").

First use



After installing or repositioning the appliance, wait at least two hours before activating it.

1. Keep the ON/OFF button on the control panel  pressed for 3 seconds to switch on the appliance.



After a power failure, the appliance will automatically switch on with the previously selected settings.



The appliance is set by default to $+5^{\circ}\text{C}$ for the fridge and -18°C for the freezer.

Door balconies and shelves

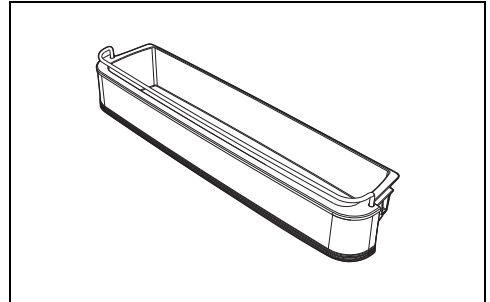



For storing foodstuffs in small containers. The shelf in the lower part of the door is useful for storing bottles.

Temperature setting



The refrigerator temperature can be set between $+1^{\circ}\text{C}$ and $+8^{\circ}\text{C}$.
The freezer temperature can be set between -18°C and -24°C .

1. To set the refrigerator temperature, press the  button; press the  button for the freezer.
2. The set temperature will be shown on the relevant display.

Preserving foodstuffs and temperature settings



The ideal temperature for preserving foodstuffs is $+4^{\circ}\text{C}$ for the refrigerator zone and -18°C for the freezer zone.





The temperatures specified above will ensure optimum preservation and minimise food waste – we therefore recommend setting the compartments to the specified temperatures ($+4^{\circ}\text{C}/-18^{\circ}\text{C}$).

Keeping the temperature at the recommended values prevents waste and ensures optimum freshness of foodstuffs; this setting also limits potential damage by freezing to delicate products.

Always consume foodstuffs by the use by date on the package.



Refrigerator super-cold function

 The refrigerator super-cold function is used for quick cooling of large quantities of food.

1. Press the  button to activate/deactivate the super-cold function, the relevant  indicator turns on.
2. After 1 hour the super-cold function is switched off automatically. The refrigerator compartment returns to its previous setting.

Vacation function



 Useful during periods of prolonged absence; the Vacation function allows you to turn off the refrigerator compartment while keeping the freezer active.

1. To activate/deactivate the Vacation function, keep the  button pressed for 3 seconds.
2. The  indicator will turn on in the display, and the temperature will not be shown .

 Remove the stored products from the refrigerator compartment.

 Useful during periods of prolonged absence; the Vacation function allows you to turn off the refrigerator compartment while keeping the freezer active.

ECO mode

1. To activate/deactivate the ECO mode, keep the  button pressed for 3 seconds.
2. The  indicator will turn on in the display.
3. The appliance will reduce power consumption after 6 hours since the activation of the ECO mode.

 The ECO mode is deactivated after a power failure or when the appliance is switched off.



 Activation of the super-cold function (refrigerator/freezer) deactivates the ECO mode.

NE

Alarm for door open

When the refrigerator compartment door remains open for a long time, the appliance sounds to warn the user that door should be closed; press the  button to deactivate the alarm.

High temperature alarm

If the temperature in the compartment is high due to prolonged power failure or to a fault of the appliance, an alarm will sound and the  indicator will turn on in the display. Check food inside the refrigerator compartment and press the  button to deactivate the alarm.

Using the accessories

Shelves

These can be positioned at different heights on the guides according to requirements. Each shelf has a safety fitting to prevent it from being accidentally removed. To extract them fully, lift up the rear part (1) and remove them (2).

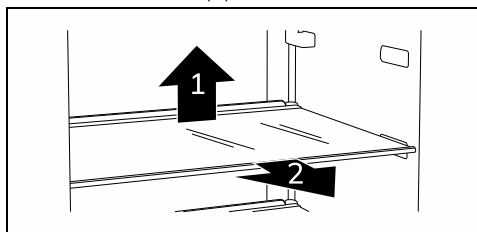

 Perishable foods should be placed on the rear part of the shelves where the temperature is lower.

Door balconies and shelves

Suitable for storing eggs, butter, dairy products, preserves and other small food packages/containers. The lower part of the door has a shelf for bottles. Avoid placing excessively heavy bottles on the shelf and do not let them drop onto the bottom when

inserting them.

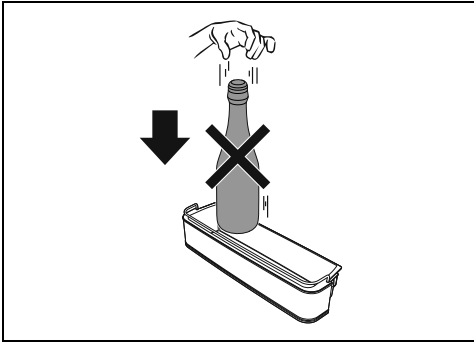

Fruit and vegetable drawer

Located at the bottom of the refrigerator compartment, which is fitted with a glass shelf to cover fresh foods that require constant humidity for optimum storage.

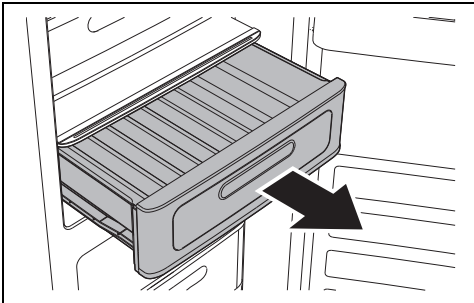

Storing vegetables with high content of water can generate condensation on the glass shelf. This is a natural phenomenon which does not affect the appliance's operation in any way.

Freezer drawers

For storing frozen foods and foods to be frozen. To remove them, pull them towards you and lift the front part of each drawer.

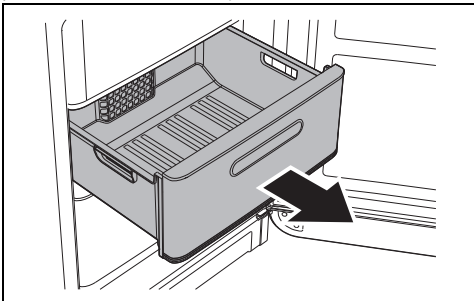

Ice packs

The use of ice packs guarantees reduced freezing times and improved freezer autonomy in case of power failure. The ice packs are removable and can be used safely in the picnic fridge or in the cooler bag.

Ventilation



Before introducing food into the appliance, seal it thoroughly.

The forced recirculation air in the appliance is free of humidity and quickly dries the food inside.

The inner ventilation system cools food more rapidly and keeps refrigeration homogeneous inside the appliance.

Using the refrigerator compartment

Arranging food

Arrange food on the various shelves, making sure that they are wrapped and covered hermetically. This precaution ensures that:

- the flavour, moisture and freshness of the foods is preserved;
- any contamination of foods with odours or tastes from other foods can be avoided;
- the humidity level inside the refrigerator is prevented from becoming too high as a result of the normal transpiration of food (especially fresh fruit and vegetables). In some operating conditions (rise in ambient temperature and humidity, more frequent opening of the door) this might cause condensation to form on the shelves.



Always allow hot foods and drinks to cool to room temperature before putting them in the appliance.

Storage life table

Foodstuff	Time
Eggs, smoked meats, marinated foods, cheese	max 10 days
Root vegetables	max 8 days
Butter	max 7 days
Pastries, fruit, ready meals, fresh meat	max 2 days
Fish, minced meat, seafood	max 1 day

Using the freezer compartment

To keep and freeze foods properly:

- pack fruit and vegetables in portions of no more than 1 kg; meat and fish in portions of up to 2 kg.
- small packages freeze quickly which means that the foods' nutritional properties are preserved better, including after defrosting/preparation.
- package foods in hermetically sealed packages, expelling air as much as possible.
- Do not use paper bags or shopping bags, use the suitable freezer bags/containers.



Always allow hot foods and drinks to cool to room temperature before putting them in the appliance.

Frozen foods storage life table

Foodstuff	Time
Fruit, beef	max 10-12 months
vegetables, veal, poultry	max 8-10 months
Game	max 6-8 months
Pork	max 4-6 months
Mince	max 4 months
Bread, desserts, cooked foods, oily fish	max 3 months
Offal	max 2 months
Sausages, lean fish	max 1 month

Defrosted foods

Food must be consumed as soon as possible once defrosted. Freezing foods preserves them, but it does not destroy any micro-organisms, which are activated after thawing, damaging the foods.

Partial defrosting lowers the nutritional value of the foodstuffs, particularly of fruit, vegetables and ready meals.

Noises during operation

The refrigerator and freezer compartments are cooled by means of a compression system. In order to maintain the preset temperature inside the refrigerator and freezer compartments, the compressor comes into operation in response to the level of cooling required, and may operate continuously if necessary. When the compressor starts up a humming sound will be heard, tending to drop in volume after a few minutes.

Another normal operating noise of the appliance is a gurgling due to the coolant

flowing through the pipes in the circuit. This noise is normal and does not indicate an appliance malfunction. If it becomes too loud, this may mean that there are other causes. Checks must then be made to ensure that:



- The refrigerator is properly levelled on the floor and does not vibrate when the compressor is in operation: if this is not the case, adjust the appliance's feet until it is level;
- The drawers, shelves and trays on the door are correctly positioned in their holders: if they are not, put them in correctly;
- Bottles and containers on the various shelves are stable and not touching each other: otherwise, the vibration resulting from compressor operation could generate noise;
- Do not place the fridge in such a way that it is in contact with furniture or other household appliances.

Heated front surface

There is a front surface heating system inside the cabinet to limit the formation of condensation around the door seal.

Turning the appliance off

Whenever the appliance is to remain unused for long periods, it should be switched off.

1. Keep the ON/OFF  button on the control panel pressed for 3 seconds. The  symbols are displayed on the refrigerator and freezer temperature displays.
2. Unplug the appliance from the wall socket.
3. Empty the compartments.
4. Once the freezer has fully defrosted, dry any residual accumulated moisture with a tea towel.



Leave the door ajar to ensure that moisture and stagnant air do not cause unpleasant odours.

Storage advice

General advice

- Always check the expiry date on the food packaging.
- The foodstuffs must be stored in closed or pre-packaged containers and must not be able to emit or absorb moisture and odours.
- Remove perishable products from the

appliance if you are going away for a long period.

Refrigerator compartment door

- Keep eggs, butter, cheese etc. in the upper and central parts.
- Keep drinks, bottles, cans etc. in the lower part.

Refrigerator compartment

- Keep preserves, wine, biscuits etc. in the upper part.
- Keep dairy products, ready meals, pastries, fruit juices, beer etc. in the central part.
- Keep meats, cold cuts etc. in the lower part.
- Keep fresh and tropical fruit, vegetables, carrots, potatoes, onions, etc. in the fruit and vegetable drawer.

Freezer compartment

- The type of food, quantity and date of freezing should be marked on the container/packaging.
- Use small containers, if possible already cold.
- The quantity of fresh foods which can be frozen at the same time is listed on the nameplate inside the refrigerator compartment.
- Use suitable freezer bags, tinfoil, cling-film for use with food, and freezer containers.
- Do not use paper bags, cellophane for non-food use, shopping bags or pre-used freezer bags.
- Avoid frozen food coming into contact with fresh food to be frozen.
- Keep bagged frozen vegetables, ice, ice cream etc.

CLEANING AND MAINTENANCE

Cleaning the appliance



See General safety instructions.

They must be cleaned regularly in order to keep them in good condition.

Cleaning the outside of the appliance

- The appliance may be cleaned with water or alcohol-based liquid detergents (e.g. window cleaning products).
- Avoid aggressive detergents and rough sponges in order not to damage the surfaces.
- Use a soft brush to remove dust and fume deposits from the condenser on the rear of the appliance.
- Clean the tank above the compressor.

Cleaning the inside of the appliance

- Clean the inside of the appliance with diluted liquid detergent and warm water, adding a little bit of vinegar.
- The door balconies and shelves can be removed: tap them upwards with your fist, first on one side and then on the other in the insertion zone.
- Remove any ice thicker than 3-5 mm. Do not use sharp objects or spray products.

Defrosting



Occasional presence of frost inside the freezer compartment is normal.



Do not use electrical appliances (e.g. hair dryers) or sprays for defrosting, the plastic parts could be damaged.

Defrosting the refrigerator compartment

The refrigerator/freezer compartment does not require defrosting, as any ice which forms on the refrigeration plate will melt when the compressor is switched off. The defrosting process is automatic.

Defrost water is channelled directly into the dedicated pan on the back of the appliance, which lets it evaporate by means of the heat generated by the compressor.

Interior lighting

Interior lighting, if damaged, must be repaired by Technical Service only.

Replacing the seal

The door seal can be replaced by the user:

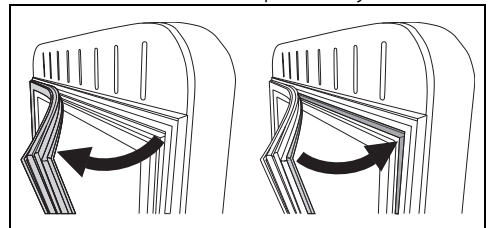

1. Remove the seal by pulling it out of its housing.
2. Reposition the new seal and press along the entire perimeter to insert it into the appropriate housing.

What to do if...

The appliance does not work:

- Make sure that the appliance is plugged in and that the main switch is turned on.

The compressor starts to function too often or functions continuously:

- The room temperature is too high.
- The door is being opened too often or for too long.
- The door is not closing/sealing properly.
- The freezer is loaded with too many fresh foods.
- Check that sufficient air can circulate around the sensor on the right-hand side of the refrigerator compartment.
- Check that the back of the refrigerator is properly ventilated and that the condenser is not too dirty.

Excessive ice or condensation has built up inside the refrigerator compartment:

- The door is being opened too often or for too long.
- Hot foods have been placed inside the refrigerator compartment.
- The foodstuffs or containers are in contact with the rear wall.
- The door seal is damaged or dirty. Clean or replace it.

The refrigerator compartment is not sufficiently cold:

- The thermostat is set at too high a temperature.
- The door is being opened too often or for too long.
- The door is not closing/sealing properly.
- The room temperature is too high.

The temperature inside the refrigerator

compartment is too cold and the foodstuffs are freezing:

- The thermostat is set at too low a temperature.
- Foodstuffs not contained in suitable containers or bags.
- Fruit and vegetables might be too wet.
- Foodstuffs placed against the rear wall of the refrigerator compartment.

Temperature inside freezer compartment not low enough to freeze foods properly:

- The thermostat is set at too high a temperature.
- The door is being opened too often or for too long.
- The door is not closing/sealing properly.
- The door seal is damaged or dirty. Clean or replace it.
- The food to be frozen contains large quantities of sugar.

Excessive ice has built up inside the freezer compartment:

- The thermostat is set at too low a temperature.
- The room temperature is too high.
- The door is being opened too often or for too long.
- The door is not closing/sealing properly.
- The door seal is damaged or dirty. Clean or replace it.
- Hot foods have been placed inside the freezer compartment.

Doors are hard to open just after closing:

- If you attempt to open the door again just after closing it (especially the freezer door), considerable strength is required. This is due to the vacuum created by the cooling of the warm air which has entered the freezer.

The doors are misaligned:

- Check that the appliance is level.
- Level the appliance using its feet.

INSTALLATION

Electrical connection



See General safety instructions.

General information

- Check the mains characteristics against the data indicated on the plate. The identification plate bearing the technical data, serial number and brand name is visibly positioned inside the appliance.

Do not remove this plate for any reason.

- Make sure that the plug and socket are of the same type.
- Avoid using adapters, gang sockets or shunts as these could cause overheating and a risk of burns.
- The plug must always be accessible when the appliance is installed.
- Leave the appliance standing vertically for at least two hours before turning it on for the first time.

- If it is necessary to replace the power cable, this must be performed by an authorised technician from Technical Support Service.

Positioning



See General safety instructions.



Refrigerator designed for use at an ambient temperature of between 10°C and 43°C.

Choice of location

Always install the appliance in a dry place with satisfactory ventilation.

- Install the appliance at least 3 cm away from electrical or gas cookers and at least 30 cm away from combustion heaters or radiators.
- The appliance must not be installed near heat sources. If this is not possible, suitable insulation must be used.
- If installed underneath wall units, at least 5 cm clearance must be left.
- Ensure that the appliance is located with sufficient space for the door to open and for the internal drawers and shelves to be removed, if necessary.

Spacers (For models with exposed condenser only)

To ensure proper cooling of the condenser, the appliance must not be placed too close to the wall. To prevent this, the appliance comes complete with two plastic spacers, which must be fitted in the rear part of the appliance.

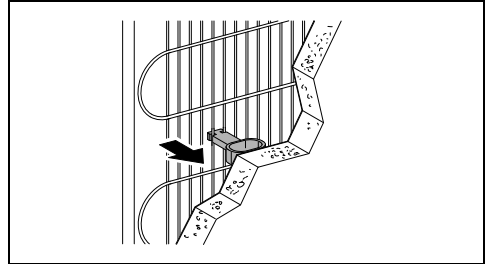
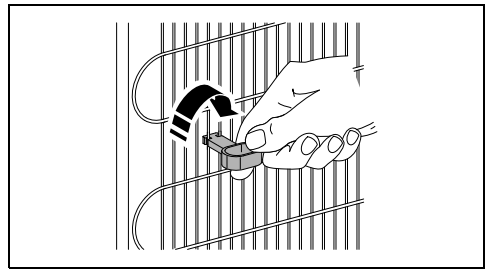
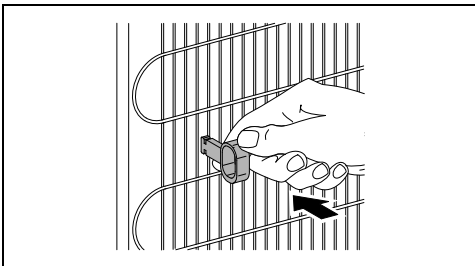

Positioning

Position the appliance on a firm, level surface.

The appliance has two small wheels on the back to allow it to be moved and positioned more easily.

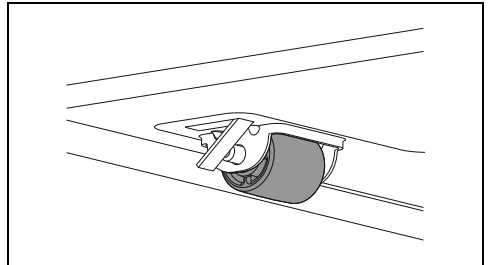

In any case, we recommend moving the appliance very carefully in order to avoid damaging the floor (especially in the case of wooden floors).

If the floor is not perfectly level, use the two adjustable feet on the front part of the appliance.

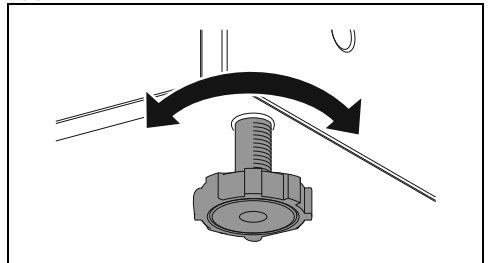

Level the appliance horizontally adjusting

its feet.

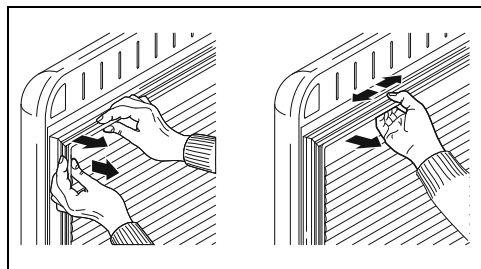
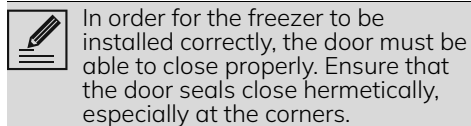
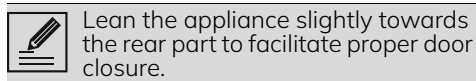

 **Pressure on the seal**
Risk of damage to the appliance

- Do not press, do not tear or detach the seal from the door.

A few days after installation, check that the initial level adjustment is still correct. Make sure that the appliance is still stable and the door seals still close hermetically when it is in operation and loaded with food. If necessary, re-adjust the level and the seals.

Appliance overall dimensions (mm)

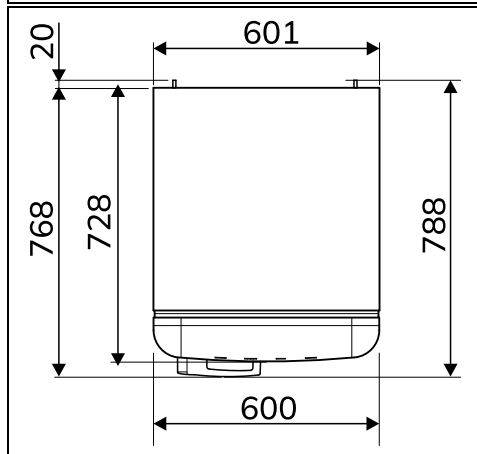
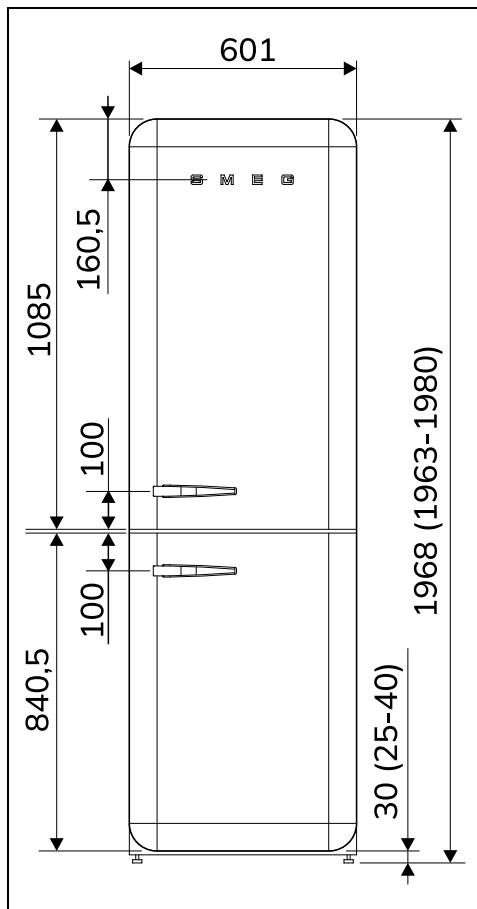

EN

