

FMI120B3

Usable volume	20 l
	
Product Family	Microwave
Category	Built-in
Installation	With frame
Power supply	Electric
Cooking Method	Microwave with grill
Control	Electronic





Controls

			
Display / Clock	TFT	Opening	Electrical button
Type of control setting	Touch control		

Options

			
Timer	Electronic	Showroom demo option	Yes
Time-setting options	End cooking	Controls Lock / Child Safety	Yes
End of cooking acoustic alarm	Yes	Quick start option	Yes
Limited Power Consumption Mode	Yes		

Technical Features

			
Cavity material	Stainless steel	Grill - power	1000 W
Shelf positions	2	Door opening	Side-opening
Shelves type	Rack	Total no. of door glasses	2
No. of lights	1	Cooling system	Tangential
Light type	Incandescent	Microwave screen protection	Yes
Light power	20 W		
Turntable	Yes	Microwave stops when door is opened	Yes
Turntable dimensions	24.5 cm		

Grill type	Quartz	Usable cavity space dimensions (HxWxD)	210x305x280 mm
		Microwave effective power	800 W

Accessories Included







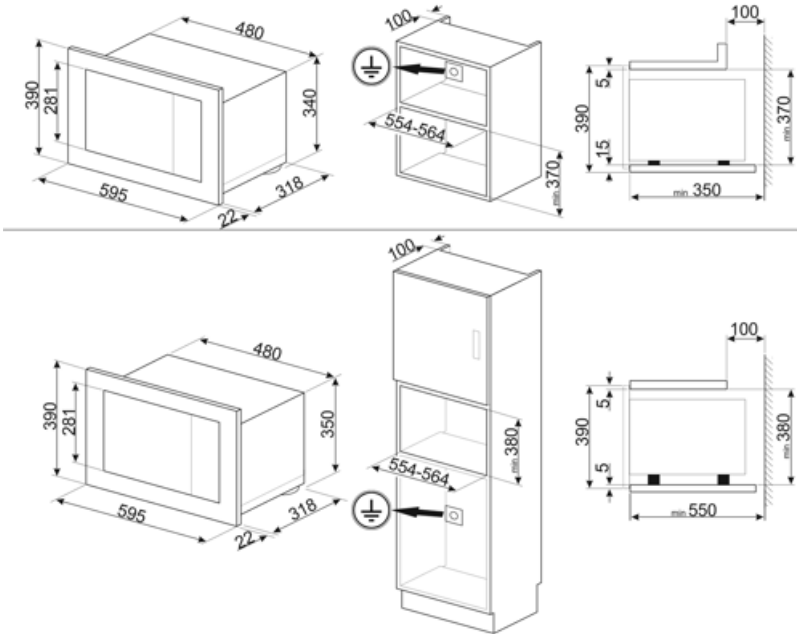



Grid	1	Frame	Yes
------	---	-------	-----

Electrical Connection

Nominal power (W)	1300 W	Frequency (Hz)	50 Hz
Current	5,2 A	Power supply cable length	150 cm
Voltage (V)	230 V		



Symbols glossary

-  Child lock: some models are fitted with a device to lock the programme/cycle so it cannot be accidentally changed.
-  Defrost by time: with this function the time of thawing of foods are determined automatically.
-  Double glazed doors: Number of glazed doors.
-  Microwave: Penetrating straight into the food, microwaves cook very quickly and with considerable energy savings. Suitable for cooking without fat, they are also able to thaw and heat food without altering its original appearance and aroma. The microwave function can also be combined with conventional functions with all the resulting advantages. Ideal for all types of food.
-  The oven cavity has 2 different cooking levels.
-  The capacity indicates the amount of usable space in the oven cavity in litres.
-  Microwave energy shortens cooking times dramatically and produces energy savings.
-  Defrost by weight: With this function the defrosting time is determined
-  Grill element: Using of grill gives excellent results when cooking meat of medium and small portions, especially when combined with a rotisserie (where possible). Also ideal for cooking sausages and bacon.
-  Microwave + grill element: The use of the grill results in a perfect browning of the surface of the food. The action of microwaves allows instead of cooking in a short time the internal part of the food.
-  Touch controls: Easy to use touch controls allow the appliance to be programmed at the touch of a button.