

FQ960BL6



| | |
|------------------|--|
| Product Family | Refrigerator |
| Installation | Free Standing |
| Category | 4 Doors |
| Reference width | Higher than 80 cm |
| Reference height | 160 - 200 cm |
| No-Frost system | Yes |
| Cooling type | Total No Frost - Double Cooling system |
| Defrost | Automatic |
| EAN code | 8017709341503 |



Aesthetics



| | | | |
|---------------|-------------|-------------------------------|-----------------------|
| Aesthetics | Victoria | Side material | Steel |
| Colour | Black | Side colour | Glossy Black |
| Design | Flat | Logo | Applied |
| Material | Metal sheet | Door shelves profile colour | Silver |
| Handle | External | Drawers profile colour | Silver |
| Handle type | Fixed | Colour of glass shelf profile | Chrome |
| Handle colour | Chrome | Display | LED |
| Logo colour | Chrome | Display position | Interior (on the top) |

Refrigerator compartment features



| | | | |
|--|--|---|-------|
| Number of compartments | 3 | Crisper Cover | Yes |
| Compartment types | Low temperature compartment, Fruit and vegetable compartment | Type of crisper/vegetable drawers cover | Glass |
| No. of adjustable shelves | 2 | Low temperature compartment | Yes |
| Number of fruit and vegetables drawers | 2 | Internal light in fridge | Yes |
| Shelves material | Glass | Type of internal light (fridge) | LED |

Type of crisper/vegetable drawers cover Standard

Refrigerator Inner Door

No. of door shelves with transparent cover 2
 No. of bottle shelves 2
 Number of adjustable door shelves 2

Other Refrigerator features



Humidity Control Yes
 Accessories Egg tray
 Natural Plus Blu Light Yes
 MultiFlow Fan Yes

Freezer compartment features

Number of drawers 4
 No. of shelves 2
 Type of shelves Glass

Other Freezer features



Fast freezing compartment Yes

Other technical features



Functions display Holiday, Fast freezing, Fast cooling, ECO
 Fast freezing button Yes
 Door open alarm Yes
 Type of temperature control Electronic
 No. of compressors 1
 Refrigerant gas type R600a
 Type of compressor Inverter
 Refrigerant Quantity (g) 62 g
 Foam agent Cyclopentane

Performance / Energy Label



Noise level 37 dB(A) re 1 pW

| | | | |
|---|--------------|-----------------------------------|--------------|
| Annual energy consumption | 338 kWh/year | Thaw time | 10 h |
| Energy efficiency class | E | 4 star - Freezing capacity | 9 kg/24h |
| Airborne acoustical noise emission class | C | 4 star - Freezing capacity | -18 kg/24h |
| Total volume | 572 l | Climatic class | SN, N, ST, T |
| Sum of the volumes of the frozen compartment(s) | 196 l | EI | 100 % |
| Sum of the volumes of the chill compartment(s) and the unfrozen compartment(s) | 376 l | | |

Electrical Connection

| | | | |
|----------------------|-----------|----------------------------------|--------------|
| Nominal power | 200 W | Frequency (Hz) | 50 Hz |
| Current | 1.2 A | Power supply cable length | 240 cm |
| Voltage (V) | 220-240 V | Plug | (F;E) Schuko |

Logistic Information

| | | | |
|---------------------------------|---------|---|---------|
| Width (mm) | 915 mm | Product width with maximum doors opening | 1370 mm |
| Depth without handle | 705 mm | Product depth with handle | 740 mm |
| Product Height with feet | 1870 mm | Product depth with doors open at 90° | 1095 mm |

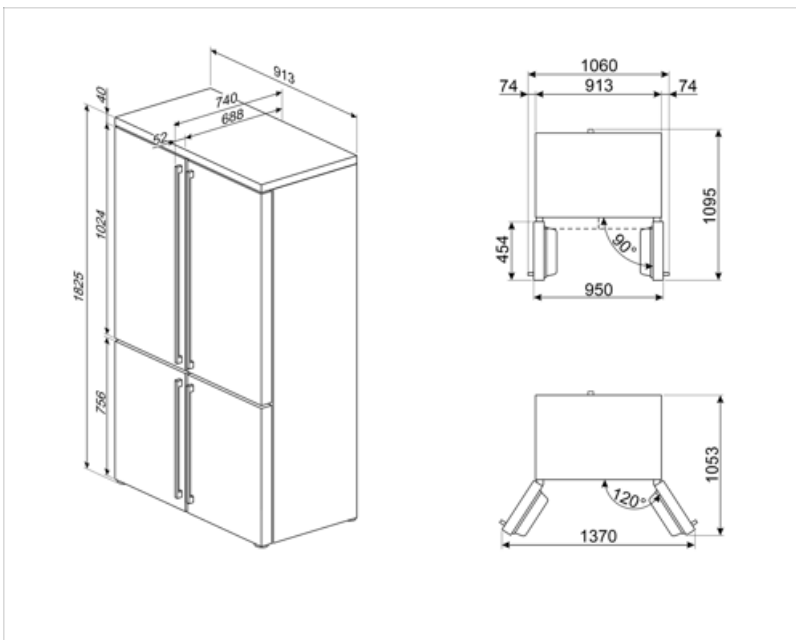

Alternative products















FQ960PB6
Pastel Blue



FQ960P6
Cream

Symbols glossary

| | | | |
|--|--|---|---|
|  | 4 stars freezing compartment for better food preservation. |  | The automatic defrost system works by automatically defrosting at regular intervals eliminating the need to defrost altogether. |
|  | Energy efficiency class E |  | LED display: to show programmes, functions and options selected and the time to the end of the cycle. |
|  | Economical mode: Analyzes fridge functioning during the activation and optimizes the operating cycle in order to reduce power consumption. |  | Ventilated: Forced distribution of cold air in the refrigerator compartment, which allows even temperature distribution within the fridge. |
|  | Fast freezing: The fast freezing function brings the temperature of the compartment down when activated a few hours prior to usage. |  | Power saving mode: The power saving mode allows you to disable the refrigerator and keep the freezer working. |
|  | LED interior lighting: is a more energy efficient and long lasting way of illuminating the interior of the appliance. |  | Inverter technology: The evolution of Smeg's driers towards more intelligent and environmentally sustainable models has led to the choice of using Inverter technology with heat pumps, which reduces significantly energy consumption. |
|  | Air plus: keeps food fresher for longer. |  | Natural Plus Blu Light: This unique Natural Plus Blu Light system works with nature to increase the storage time of fruit and vegetables. |