

FQ960P6



Product Family	Refrigerator
Installation	Free Standing
Category	4 Doors
Reference width	Higher than 80 cm
Reference height	160 - 200 cm
No-Frost system	Yes
Cooling type	Total No Frost - Double Cooling system
Defrost	Automatic
EAN code	8017709341510



Aesthetics



Aesthetics	Victoria	Side material	Steel
Colour	Cream	Side colour	Cream
Design	Flat	Logo	Applied
Material	Metal sheet	Door shelves profile colour	Silver
Handle	External	Drawers profile colour	Silver
Handle type	Fixed	Colour of glass shelf profile	Chrome
Handle colour	Chrome	Display	LED
Logo colour	Chrome	Display position	Interior (on the top)

Refrigerator compartment features



Number of compartments	3	Crisper Cover	Yes
Compartment types	Low temperature compartment, Fruit and vegetable compartment	Type of crisper/vegetable drawers cover	Glass
No. of adjustable shelves	2	Low temperature compartment	Yes
Number of fruit and vegetables drawers	2	Internal light in fridge	Yes
Shelves material	Glass	Type of internal light (fridge)	LED

Type of crisper/vegetable drawers cover Standard

Refrigerator Inner Door

No. of door shelves with transparent cover 2
 No. of bottle shelves 2
 Number of adjustable door shelves 2

Other Refrigerator features



Humidity Control Yes
 Accessories 2 sliders, Egg tray
 Natural Plus Blu Light Yes
 MultiFlow Fan Yes

Freezer compartment features

Number of drawers 4
 No. of shelves 2
 Type of shelves Glass

Other Freezer features



Fast freezing compartment Yes

Other technical features



Functions display Holiday, Fast freezing, Fast cooling, ECO
 Fast freezing button Yes
 Door open alarm Yes
 Type of temperature control Electronic
 No. of compressors 1
 Refrigerant gas type R600a
 Type of compressor Inverter
 Refrigerant Quantity (g) 62 g
 Foam agent Cyclopentane

Performance / Energy Label



Noise level 37 dB(A) re 1 pW

Annual energy consumption	338 kWh/year	Thaw time	10 h
Energy efficiency class	E	4 star - Freezing capacity	9 kg/24h
Airborne acoustical noise emission class	C	4 star - Freezing capacity	-18 kg/24h
Total volume	572 l	Climatic class	SN, N, ST, T
Sum of the volumes of the frozen compartment(s)	196 l	EI	100 %
Sum of the volumes of the chill compartment(s) and the unfrozen compartment(s)	376 l		

Electrical Connection

Nominal power	200 W	Frequency (Hz)	50 Hz
Current	1.2 A	Power supply cable length	240 cm
Voltage (V)	220-240 V	Plug	(F;E) Schuko

Logistic Information

Width (mm)	915 mm	Product width with maximum doors opening	1370 mm
Depth without handle	705 mm	Product depth with handle	740 mm
Product Height with feet	1870 mm	Product depth with doors open at 90°	1095 mm

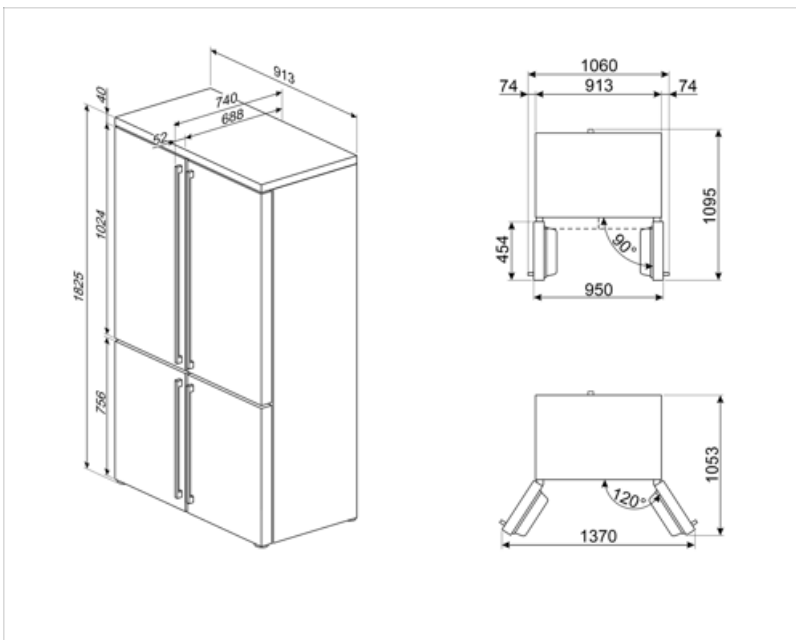

Alternative products















FQ960PB6
Pastel Blue



FQ960BL6
Black

Symbols glossary

	4 stars freezing compartment for better food preservation.		The automatic defrost system works by automatically defrosting at regular intervals eliminating the need to defrost altogether.
	LED display: to show programmes, functions and options selected and the time to the end of the cycle.		Economical mode: Analyzes fridge functioning during the activation and optimizes the operating cycle in order to reduce power consumption.
	Ventilated: Forced distribution of cold air in the refrigerator compartment, which allows even temperature distribution within the fridge.		Fast freezing: The fast freezing function brings the temperature of the compartment down when activated a few hours prior to usage.
	Power saving mode: The power saving mode allows you to disable the refrigerator and keep the freezer working.		LED interior lighting: is a more energy efficient and long lasting way of illuminating the interior of the appliance.
	Inverter technology: The evolution of Smeg's driers towards more intelligent and environmentally sustainable models has led to the choice of using Inverter technology with heat pumps, which reduces significantly energy consumption.		Air plus: keeps food fresher for longer.
	Natural Plus Blu Light: This unique Natural Plus Blu Light system works with nature to increase the storage time of fruit and vegetables.		Energy efficiency class E