



**Register** your  
new device on  
MyBosch now and  
get free benefits:  
**[bosch-home.com/  
welcome](https://bosch-home.com/welcome)**



# Oven

**HMG7764.1B**

[en] User manual and installation instructions

**Further information and explanations are available online:**



## Table of contents

### INFORMATION FOR USE

1	Safety.....	2
2	Preventing material damage .....	6
3	Environmental protection and saving energy .....	7
4	Familiarising yourself with your appliance .....	8
5	Operating modes .....	10
6	Accessories.....	11
7	Before using for the first time .....	13
8	Basic operation .....	13
9	Rapid heating .....	15
10	Time-setting options.....	15
11	Microwave .....	16
12	Ventilation function Crisp Finish .....	18
13	Meat probe.....	19
14	Dishes .....	21
15	Favourites.....	22
16	Childproof lock.....	23
17	Basic settings.....	23
18	Home Connect .....	25
19	Cleaning and servicing.....	27
20	Pyrolytic activeClean cleaning function.....	28
21	Cleaning aid.....	30
22	Drying .....	30
23	Appliance door.....	31
24	Rails .....	32
25	Troubleshooting.....	33
26	Disposal.....	35
27	Customer Service.....	35
28	Information regarding Free and Open Source Software.....	35
29	Declaration of Conformity .....	36
30	How it works.....	36

31	INSTALLATION INSTRUCTIONS .....	50
31.1	General installation instructions.....	50



## 1 Safety

Observe the following safety instructions.

### 1.1 General information

- Read this instruction manual carefully.
- Keep the instruction manual and the product information safe for future reference or for the next owner.
- Do not connect the appliance if it has been damaged in transit.

### 1.2 Intended use

This appliance is designed only to be built into kitchen units. Read the special installation instructions.

Only a licensed professional may connect appliances without plugs. Damage caused by incorrect connection is not covered under the warranty.

Only use this appliance:

- To prepare meals and drinks.
- For household use and similar applications, such as: In kitchens for employees in shops, offices and other commercial sectors; in agriculture; by customers in hotels and other residential facilities; in bed and breakfasts.
- up to an altitude of max. 4000 m above sea level.

This appliance complies with the standards EN 55011 and CISPR 11. It is a group 2, class B product. Group 2 means that microwaves are produced for the purpose of heating food. Class B means that the appliance is suitable for private households.

### 1.3 Restriction on user group

This appliance may be used by children aged 8 or over and by people who have reduced physical, sensory or mental abilities or inad-

equate experience and/or knowledge, provided that they are supervised or have been instructed on how to use the appliance safely and have understood the resulting dangers.

Do not let children play with the appliance. Children must not perform cleaning or user maintenance unless they are at least 15 years old and are being supervised.

Keep children under the age of 8 years away from the appliance and power cable.

#### 1.4 Safe use

Always place accessories in the cooking compartment the right way round.

→ "Accessories", Page 11

#### **⚠ WARNING – Risk of fire!**

Combustible objects that are left in the cooking compartment may catch fire.

- ▶ Never store combustible objects in the cooking compartment.
- ▶ If smoke is emitted, the appliance must be switched off or the plug must be pulled out and the door must be held closed in order to stifle any flames.

Loose food remnants, fat and meat juices may catch fire.

- ▶ Before using the appliance, remove the worst of the food residues and remnants from the cooking compartment, heating elements and accessories.

Opening the appliance door creates a draught. Greaseproof paper may come into contact with the heating element and catch fire.

- ▶ Never place greaseproof paper loosely over accessories when preheating the appliance and while cooking.
- ▶ Always cut greaseproof paper to size and use a plate or baking tin to hold it down.

#### **⚠ WARNING – Risk of burns!**

The appliance and its parts that can be touched become hot during use.

- ▶ Caution should be exercised here in order to avoid touching heating elements.
- ▶ Young children under 8 years of age must be kept away from the appliance.

Accessories and cookware get very hot.

- ▶ Always use oven gloves to remove accessories or cookware from the cooking compartment.

When the cooking compartment is hot, any alcoholic vapours inside may catch fire. The appliance door may spring open. Hot steam and jets of flame may escape.

- ▶ Only use small quantities of drinks with a high alcohol content in food.
- ▶ Do not heat spirits ( $\geq 15\%$  vol.) when undiluted (e.g. for marinating or pouring over food).
- ▶ Open the appliance door carefully.

#### **⚠ WARNING – Risk of scalding!**

The accessible parts of the appliance become hot during operation.

- ▶ Never touch these hot parts.
- ▶ Keep children at a safe distance.

Hot steam may escape when you open the appliance door. Steam may not be visible, depending on the temperature.

- ▶ Open the appliance door carefully.
- ▶ Keep children at a safe distance.

If there is water in the cooking compartment when it is hot, this may create hot steam.

- ▶ Never pour water into the cooking compartment when the cooking compartment is hot.

#### **⚠ WARNING – Risk of injury!**

Scratched glass in the appliance door may develop into a crack.

- ▶ Do not use any harsh or abrasive cleaners or sharp metal scrapers to clean the glass on the oven door, as they may scratch the surface.

The appliance and its parts that can be touched may have sharp edges.

- ▶ Take care when handling and cleaning them.
- ▶ If possible, wear protective gloves.

The hinges on the appliance door move when the door is opened and closed, which could trap your fingers.

- ▶ Keep your hands away from the hinges. Components inside the appliance door may have sharp edges.
- ▶ Wear protective gloves.

**⚠ WARNING – Risk of electric shock!**

Improper repairs are dangerous.

- ▶ Repairs to the appliance should only be carried out by trained specialist staff.
- ▶ Only use genuine spare parts when repairing the appliance.
- ▶ If the power cord of this appliance is damaged, it must be replaced by the manufacturer, the manufacturer's Customer Service or a similarly qualified person in order to prevent any risk.

If the insulation of the power cord is damaged, this is dangerous.

- ▶ Never let the power cord come into contact with hot appliance parts or heat sources.
- ▶ Never let the power cord come into contact with sharp points or edges.
- ▶ Never kink, crush or modify the power cord.

An ingress of moisture can cause an electric shock.

- ▶ Do not use steam- or high-pressure cleaners to clean the appliance.

If the appliance or the power cord is damaged, this is dangerous.

- ▶ Never operate a damaged appliance.
- ▶ Never pull on the power cord to unplug the appliance. Always unplug the appliance at the mains.
- ▶ If the appliance or the power cord is damaged, immediately unplug the power cord or switch off the fuse in the fuse box.
- ▶ Call customer services. → *Page 35*

**⚠ WARNING – Risk of suffocation!**

Children may put packaging material over their heads or wrap themselves up in it and suffocate.

- ▶ Keep packaging material away from children.
- ▶ Do not let children play with packaging material.

Children may breathe in or swallow small parts, causing them to suffocate.

- ▶ Keep small parts away from children.
- ▶ Do not let children play with small parts.

**1.5 Microwave**

CAREFULLY READ THE IMPORTANT SAFETY INSTRUCTIONS AND KEEP THEM SAFE FOR FUTURE USE

**⚠ WARNING – Risk of fire!**

Using the appliance for anything other than its intended purpose is dangerous and may cause damage. For example, heated slippers and pillows filled with grain or cereal may catch fire, even several hours later.

- ▶ Never dry food or clothing with the appliance.
- ▶ Never heat up slippers, pillows filled with grain or cereal, sponges, damp cleaning cloths or similar with the appliance.
- ▶ The appliance must only be used to prepare food and drink.

Food and its packaging and containers may catch fire.

- ▶ Never heat food in heat-retaining packaging.
- ▶ Do not leave food unattended while it is heating in containers made of plastic, paper or other combustible materials.
- ▶ Never set the microwave power too high or the cooking time too long. Follow the instructions provided in this user manual.
- ▶ Never use the microwave to dry food.
- ▶ Never defrost or heat food with a low water content, such as bread, at too high a microwave power or for too long.

Cooking oil may catch fire.

- ▶ Never use the microwave to heat cooking oil on its own.

**⚠ WARNING – Risk of explosion!**

Liquids and other food may easily explode when in containers that have been tightly sealed.

- ▶ Never heat liquids or other food in containers that have been tightly sealed.

**⚠ WARNING – Risk of burns!**

Foods with peel or skin may burst or explode during heating, or even afterwards.

- ▶ Never cook eggs in their shell or heat hard-boiled eggs in their shell.
- ▶ Never cook shellfish or crustaceans.
- ▶ Always prick the yolk of eggs before microwaving.
- ▶ The skin of foods that have a peel or skin, such as apples, tomatoes, potatoes and sausages, may burst. Before heating, prick the peel or skin.

Heat is not distributed evenly through baby food.

- ▶ Never heat baby food in closed containers.

- ▶ Always remove the lid or teat.
- ▶ Stir or shake well after heating.
- ▶ Check the temperature before giving the food or drink to a child.

Heated food gives off heat. The cookware may become hot.

- ▶ Always use oven gloves to remove cookware or accessories from the cooking compartment.

Airtight packaging may burst when food is heated.

- ▶ Always follow the instructions on the packaging.
- ▶ Always use oven gloves to remove the dishes from the cooking compartment.

The accessible parts of the appliance become hot during operation.

- ▶ Never touch these hot parts.
- ▶ Keep children at a safe distance.

At the highest settings in microwave only mode, the drying function will automatically switch on an additional heating element to heat the cooking compartment.

- ▶ Never touch the inside surfaces of the cooking compartment or the heating elements while they are hot.
- ▶ Keep children at a safe distance.

Using the appliance for anything other than its intended purpose is dangerous. This is because, for instance, overheated slippers, pillows filled with grain or cereal, sponges and damp cleaning cloths, etc., may cause burns to the skin.

- ▶ Never dry food or clothing with the appliance.
- ▶ Never heat up slippers, pillows filled with grain or cereal, sponges, damp cleaning cloths or similar with the appliance.
- ▶ The appliance must only be used to prepare food and drink.

### **⚠ WARNING – Risk of scalding!**

There is a possibility of delayed boiling when a liquid is heated. This means that the liquid reaches the boiling temperature without the usual steam bubbles rising to the surface. Exercise caution even when only gently shaking the container. The hot liquid may suddenly boil over and splatter.

- ▶ Always place a spoon in the container when heating liquids. This prevents delayed boiling.

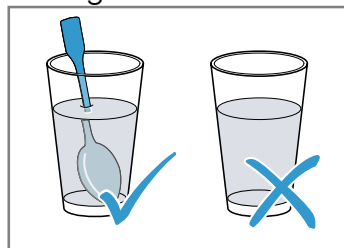

### **⚠ WARNING – Risk of injury!**

Unsuitable cookware may crack. Porcelain or ceramic cookware can have small perforations in the handles and lid. These perforations conceal a cavity below. If moisture penetrates this cavity, it could cause the cookware to crack.

- ▶ Only use microwave-safe cookware. Cookware and containers made from metal or cookware with metal edging may lead to sparks being formed during simple microwave operation. The appliance is damaged.
- ▶ Never use metal containers during microwave-only operation.
- ▶ Only use microwave-safe cookware or use the microwave in combination with a type of heating.

### **⚠ WARNING – Risk of electric shock!**

The appliance uses a high voltage.

- ▶ Never remove the casing.

### **⚠ WARNING – Risk of serious harm to health!**

Inadequate cleaning may destroy the surface of the appliance, reduce its service life, and lead to dangerous situations, such as escaping microwave energy.

- ▶ Clean the appliance on a regular basis, and remove any food residue immediately.
- ▶ Always keep the cooking compartment, door seal, door and door stop clean.  
→ "Cleaning and servicing", Page 27

Never operate the appliance if the cooking compartment door or the door seal is damaged. Microwave energy may escape.

- ▶ Never use the appliance if the cooking compartment door, the door seal or the plastic door frame is damaged.
- ▶ Any repair work must only be carried out by the after-sales service.

Microwave energy will escape from appliances that do not have any casing.

- ▶ Never remove the casing.
- ▶ Contact our after-sales service if maintenance or repair work is needed.

### 1.6 Meat probe

#### **⚠ WARNING – Risk of electric shock!**

Using the wrong meat probe could damage the insulation.

- ▶ Only use the meat probe for this specific appliance.

#### **⚠ WARNING – Risk of injury!**

The meat probe is sharp.

- ▶ Handle the meat probe with care.

### 1.7 Cleaning function

#### **⚠ WARNING – Risk of fire!**

Loose food remnants, fat and meat juices may catch fire when the cleaning function is in progress.

- ▶ Before you start the cleaning function, always remove coarse dirt from the cooking compartment.
- ▶ Never clean accessories at the same time.

The outside of the appliance gets very hot when the cleaning function is in progress.

- ▶ Never hang combustible objects, e.g. tea towels, on the door handle.
- ▶ Leave the front of the appliance clear.
- ▶ Keep children at a safe distance.

If the door seal is damaged, a large amount of heat is generated around the door.

- ▶ Do not scrub or remove the seal.
- ▶ Never operate the appliance if the seal is damaged or missing.

#### **⚠ WARNING – Risk of serious harm to health!**

The appliance gets very hot when the cleaning function is in progress. The non-stick coating on baking trays and tins is destroyed and noxious gases are released.

- ▶ Never clean non-stick baking trays or baking tins using the cleaning function.
- ▶ Never clean accessories at the same time.

#### **⚠ WARNING – Risk of harm to health!**

The cleaning function heats up the cooking compartment to a very high temperature so that food left over from roasting, grilling and baking will burn off. This process releases vapours, which can irritate mucous membranes.

- ▶ Keep the kitchen well ventilated while the cleaning function is running.
- ▶ Do not remain in the room for long periods.
- ▶ Keep children and pets away.

#### **⚠ WARNING – Risk of burns!**

The cooking compartment gets very hot when the cleaning function is in progress.

- ▶ Never open the appliance door.
- ▶ Allow the appliance to cool down.
- ▶ Keep children at a safe distance.

**⚠** The outside of the appliance gets very hot when the cleaning function is in progress.

- ▶ Never touch the appliance door.
- ▶ Allow the appliance to cool down.
- ▶ Keep children at a safe distance.

---

## 2 Preventing material damage

### 2.1 General

#### **ATTENTION!**

Alcoholic vapours may catch fire in the hot cooking compartment and cause permanent damage to the appliance. The appliance door may spring open due to an explosion and it may fall off. The door panels may shatter and fragment. Due to the resulting negative pressure, the cooking compartment may become considerably deformed inwards.

- ▶ Do not heat spirits ( $\geq 15\%$  vol.) when undiluted (e.g. for marinating or pouring over food).

If there is water on the cooking compartment floor when operating the appliance at temperatures above  $120\text{ }^{\circ}\text{C}$ , this will damage the enamel.

- ▶ Do not use the appliance if there is water on the cooking compartment floor.
- ▶ Wipe away any water on the cooking compartment floor before operation.

Objects on the cooking compartment floor at over 50 °C will cause heat to build up. The baking and roasting times will no longer be correct and the enamel will be damaged.

- ▶ Do not place any accessories, greaseproof paper or foil of any kind on the cooking compartment floor.
- ▶ Only place cookware on the cooking compartment floor if a temperature under 50 °C has been set.

Using silicone moulds or any film, covers or accessories that contain silicone could damage the baking sensor. Damage may occur even if the baking sensor is not active.

- ▶ Do not use silicone moulds or any film, covers or accessories that contain silicone.
- ▶ Never place objects made of silicone in the cooking compartment.

When the cooking compartment is hot, any water inside it will create steam. The change in temperature may cause damage.

- ▶ Never pour water into the cooking compartment when it is still hot.
- ▶ Never place cookware containing water on the cooking compartment floor.

The prolonged presence of moisture in the cooking compartment leads to corrosion.

- ▶ Allow the cooking compartment to dry after use. To do this, open the cooking compartment door completely or use the drying function.
- ▶ Do not keep moist food in the cooking compartment for a long time with the door closed.
- ▶ Do not store food in the cooking compartment.
- ▶ Take care not to trap anything in the appliance door.

Fruit juice dripping from the baking tray leaves stains that cannot be removed.

- ▶ When baking very juicy fruit flans, do not pack too much on the baking tray.
- ▶ If possible, use the deeper universal pan.

Using oven cleaner in a hot cooking compartment damages the enamel.

- ▶ Never use oven cleaner in the cooking compartment when it is still warm.
- ▶ Remove all food remnants from the cooking compartment and the appliance door before you next heat up the appliance.

If the seal is very dirty, the appliance door will no longer close properly during operation. This may damage the front of adjacent kitchen units.

- ▶ Keep the seal clean at all times.
- ▶ Never operate the appliance if the seal is damaged or missing.

Sitting or placing objects on the appliance door may damage it.

- ▶ Do not place, hang or support objects on the appliance door.
- ▶ Do not place cookware or accessories on the appliance door.

With certain models, accessories may scratch the door pane when closing the appliance door.

- ▶ Always push accessories fully into the cooking compartment.

If aluminium foil comes into contact with the door pane, it could cause permanent discolouration.

- ▶ Do not allow aluminium foil in the cooking compartment to come into contact with the door pane.

## 2.2 Microwave

Follow these instructions when using the microwave.

### ATTENTION!

Metal touching the wall of the cooking compartment will cause sparks, which may damage the appliance or the inner door pane.

- ▶ Metal (e.g. a spoon in a glass) must be kept at least 2 cm from the cooking compartment walls and the inside of the door.

Using accessories directly on top of one another causes sparks.

- ▶ Do not combine the wire rack with the universal pan.

- ▶ Always place accessories on different levels.

The universal pan and baking tray are not suitable for use with microwave-only mode. Using either of these may create sparks, which will damage the cooking compartment.

- ▶ Place accessories on the wire rack supplied.

Placing aluminium containers in the appliance may cause sparks, which will damage the appliance.

- ▶ Do not use aluminium containers in the appliance.

Operating the appliance without food in the cooking compartment may lead to overloading.

- ▶ Do not switch on the microwave unless there is food inside. The only exception to this rule is when performing a short cookware test.

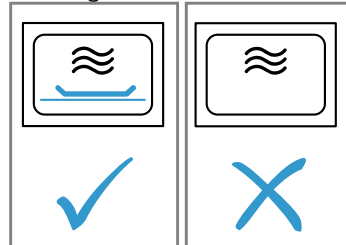

If you prepare microwave popcorn at a microwave power level that is too high, the door pane may crack due to overloading.

- ▶ Never set a microwave power level that is too high.
- ▶ Use a maximum microwave output of 600 watts.
- ▶ Always place the popcorn bag on a glass plate.

## 3 Environmental protection and saving energy

### 3.1 Disposing of packaging

The packaging materials are environmentally compatible and can be recycled.

- ▶ Sort the individual components by type and dispose of them separately.

### 3.2 Saving energy

If you follow these instructions, your appliance will use less power.

Only preheat the appliance if the recipe or the recommended settings tell you to do so.

→ "How it works", Page 36

- Not preheating the appliance can reduce the energy used by up to 20%.

Use dark-coloured, black-coated or enamelled baking tins.

- These types of baking tin absorb the heat particularly well.

Open the appliance door as little as possible during operation.

- This maintains the temperature in the cooking compartment and eliminates the need for the appliance to reheat.

When baking multiple dishes, do so in succession or in parallel.

- The cooking compartment is heated after baking the first dish. This reduces the baking time for the second cake.

If the cooking time is relatively long, you can switch the appliance off 10 minutes before the cooking time ends.

- There will be enough residual heat to finish cooking the dish.

Remove any accessories that are not being used from the cooking compartment.

- Accessories that are not being used do not need to be heated.

Allow frozen food to defrost before cooking.

- This saves the energy that would otherwise be required to defrost it.

Switch off the display in the basic settings.

→ "Basic settings", Page 23

- Energy is saved when the display is switched off.

Heat two glasses or cups of liquid at the same time.

- Heating several dishes at the same time requires less energy than heating dishes one after the other.

#### Note:

The appliance requires:

- A maximum of 2 W in networked standby mode
- A maximum of 0.5 W in non-networked standby mode with the display switched off

## 4 Familiarising yourself with your appliance

### 4.1 Control panel

You can use the control panel to configure all functions of your appliance and to obtain information about the operating status.

On certain models, specific details such as colour and shape may differ from those pictured.

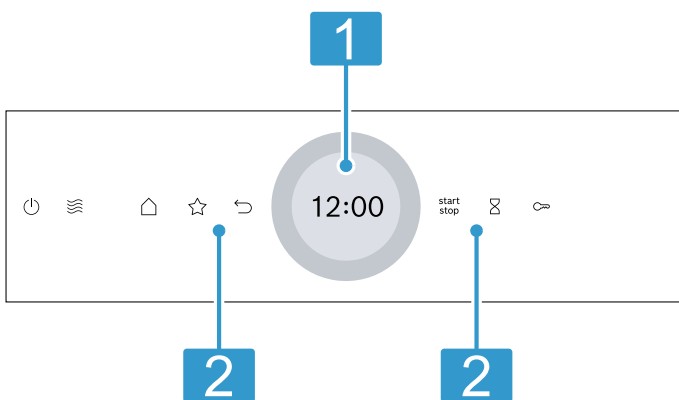

#### 1 Display with setting ring

You can use the digital setting ring to set the appliance via the display. You will see the current setting values, options or relevant information.  
→ "Display", Page 8

#### 2 Buttons

You can use the buttons to directly set various functions.  
→ "Buttons", Page 8

### 4.2 Buttons

You can use the buttons to directly select various functions.

Button	Function
	Switch the appliance on or off. → "Basic operation", Page 13
	Select the microwave operating mode directly. → "Microwave", Page 16
	Open the "Operating modes" menu. → "Operating modes", Page 10
	Select the favourites operating mode directly. → "Favourites", Page 22
	Go back one setting.
	Start or pause operation. → "Basic operation", Page 13
	Select the timer. → "Setting the timer", Page 16
	Press and hold for approx. 4 seconds to activate the childproof lock. → "Childproof lock", Page 23

### 4.3 Display

The display is divided into different areas.

#### Digital setting ring

You can use the digital setting ring on the display to change the setting values.









When you reach the minimum or maximum value available, this value remains on the display. If required, use the setting ring to turn the value back again.

### Finely tuned setting values

To fine-tune the setting values, e.g. to set a time to the precise minute, press and hold the corresponding area in the setting ring for around 1 - 2 seconds. The finely tuned setting values are shown in dots.

### Status indicator



Status information is shown at the top of the display.

Symbol	Meaning
	Timer is activated. → "Setting the timer", Page 16
	Childproof lock is activated. → "Childproof lock", Page 23
	The appliance door is locked due to the cleaning function or childproof lock. → "Pyrolytic activeClean cleaning function", Page 28 → "Basic settings", Page 23
	WiFi signal strength for Home Connect. The more lines of the symbol are filled, the better the signal. If the symbol is struck through  , there is no WiFi signal. If there is an "x" at the symbol  , there is no connection to the Home Connect server. → "Home Connect ", Page 25
	Remote start with Home Connect is activated. → "Home Connect ", Page 25
	Remote diagnostics with Home Connect for maintenance is activated. → "Home Connect ", Page 25

### Settings area

The settings area is in the centre of the display. You can see current options and settings that have already been made in the settings area. The menu and other setting options are arranged horizontally. Selection lists for functions are vertically arranged. Swipe over the display to scroll in the settings area. To select a function, press the function on the display.  
→ "Setting the operating mode", Page 13

### Possible symbols in the settings area

Symbol	Meaning
	Confirm the setting value.
	Reset the setting value.
	Change the setting value while the appliance is in operation.

**Note:** A blue marking "new" or a blue dot on a function indicates that a new function, a new favourite or an update was downloaded to your appliance using the Home Connect app.

## 4.4 Cooking compartment

Various functions in the cooking compartment provide support when operating your appliance.

### Shelf supports

The shelf supports in the cooking compartment enable you to place accessories at different heights.

→ "Accessories", Page 11

Your appliance has 5 shelf positions. The shelf positions are numbered from bottom to top.

You can remove the shelf supports, e.g. for cleaning.  
→ "Rails", Page 32

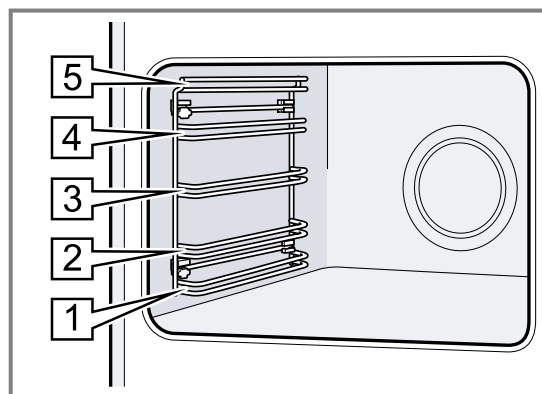

### Lighting

One or more oven lights illuminate the cooking compartment.

When you open the appliance door, the light in the cooking compartment switches on. If the appliance door remains open for longer than around 18 minutes, the light switches off again.

For most operating modes, the lighting is switched on during operation. The lighting switches off again when the operation ends.

### Cooling fan

The cooling fan switches on and off depending on the appliance's temperature. The hot air escapes above the door.

#### ATTENTION!

Covering the ventilation slots will cause the appliance to overheat.

- ▶ Do not cover the ventilation slots.

To ensure that the appliance cools down more quickly after operation, the cooling fan continues to run for a certain period afterwards.

### Appliance door

If you open the appliance door during operation, the operation stops. If you close the appliance door, operation resumes automatically.

In microwave mode, if you close the appliance door, you must continue the operation.

## 5 Operating modes







This is where you can find an overview of your appliance's operating modes and main functions. Press  to open the menu.

Operating mode	Use
Types of heating	Select finely tuned types of heating for the optimal preparation of your food. → "Types of heating", Page 10 → "Basic operation", Page 13
Microwave	Cook, heat or defrost more quickly with the microwave. → "Microwave", Page 16
Favourites	Use your own saved settings. → "Favourites", Page 22
Dishes	Use programmed, recommended settings for various types of food. → "Dishes", Page 21

### 5.1 Types of heating

To ensure that you always find the right type of heating to cook your food, we explain the differences and applications below.

The symbols for each type of heating help you to remember them.

Symbol	Type of heating	Temperature range	What it's used for and how it works
	4D hot air	30 - 275 °C	Bake or roast on one or more levels. The fan distributes the heat from the ring-shaped heating element in the back wall evenly around the cooking compartment.
	Top/bottom heating	30 - 300 °C	Traditionally bake or roast on one level. This type of heating is especially good for cakes with moist toppings. The heat is emitted evenly from above and below.
	Gentle hot air	125 - 250 °C	Cook selected dishes gently on one level without preheating. The fan distributes the heat from the ring-shaped heating element in the back wall evenly around the cooking compartment. The food is cooked in phases using residual heat. Always keep the appliance door closed when cooking. This type of heating is used to determine the energy consumption in air recirculation mode and the energy efficiency class.
	Air Fry	30 - 300 °C	Cook until crispy, on one level with little fat. Especially suitable for food that is usually fried in oil, e.g. chips. The fan circulates heat from the grill element around the food at high speed. The exhaust air is extracted more intensively from of the cooking compartment.
	Gentle top/bottom heating	150 - 250 °C	Gently cook selected dishes. Heat is emitted from above and below. This type of heating is used to measure the energy consumption in the conventional mode.
	Circulated air grilling	30 - 300 °C	Roast poultry, whole fish or larger pieces of meat. The grill element and the fan switch on and off alternately. The fan circulates the hot air around the food.

Operating mode	Use
Cleaning	Select the cleaning function for the cooking compartment. → "Pyrolytic activeClean cleaning function", Page 28 → "Cleaning aid", Page 30 → "Drying", Page 30
Basic settings	Adjust the basic settings. → "Basic settings", Page 23

### Home Connect









With Home Connect, you can connect and remotely control the oven with a mobile device, and use the full functionality of the appliance.

Depending on the appliance type, additional or more comprehensive functions are available for your appliance with the Home Connect app. You can find more information about this in the app.

→ "Home Connect ", Page 25

When you select a type of heating, the appliance suggests a suitable temperature or setting. You can use these values or change them within the specified range.

For temperature settings above 275 °C and grill setting 3, the appliance reduces the temperature to approx. 275 °C or grill setting 1 after approx. 40 minutes.

Symbol	Type of heating	Temperature range	What it's used for and how it works
	Full-surface grill	Grill settings: 1 = low 2 = medium 3 = high	Grill flat items such as steak and sausages, or make toast. Gratinated food. The entire area below the grill element becomes hot.
	Centre-area grill	Grill settings: 1 = low 2 = medium 3 = high	Grill small quantities such as steak and sausages, or make toast. Gratinated small quantities of food. The central area below the grill element becomes hot.
	Pizza setting	30 - 275 °C	Cook pizza or food that requires a lot of heat from below. The bottom heating element and the ring-shaped heating element in the back wall heat the cooking compartment.
	Slow cooking	70 - 120 °C	Slowly and gently cook seared, tender pieces of meat in uncovered cookware. The heat is emitted evenly from above and below at a low temperature.
	Defrost	30 - 60 °C	Gently defrost frozen food.
	Bottom heating	30 - 250 °C	Final baking or cooking food in a bain marie. The heat is emitted from below.
	Keeping warm	50 - 100 °C	Keep cooked food warm.
	Plate warming	30 - 90 °C	Preheat cookware.

## 5.2 Temperature

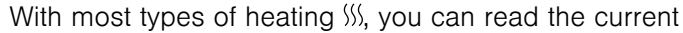
With most types of heating , you can read the current temperature in the cooking compartment from approx. 30 °C and the set temperature side-by-side on the display during heating, e.g. 120|210 °C.

When you are preheating the appliance, the optimal time to place the food in the cooking compartment is as soon as the displayed temperature in the cooking compartment and the set temperature are the same.

**Note:** Due to thermal inertia, the temperature that is displayed may differ slightly from the actual temperature inside the cooking compartment.

### Residual heat indicator

When the appliance is switched off, a red line around the control ring indicates the residual heat in the cooking compartment. The further the temperature drops, the darker the ring. The ring goes out completely at approx. 60 °C.

## 5.3 Microwave output settings

This is where you can find an overview of the different microwave output settings and recommendations on when to use them.

Microwave output in watts	Maximum cooking time in hours	Use
90 W	1:30	Defrost delicate foods.
180 W	1:30	Defrost food and continue cooking.
360 W	1:30	Cook fish and meat. Heat up delicate foods.
600 W	1:30	Heat and cook food.
800 W "Boost"	00:30	Heat liquids.

### Notes

- To protect the appliance, the maximum microwave output "Boost" is gradually reduced to 600 watts during the first few minutes. Maximum output is made available again after a cooling period.

- The microwave output settings do not correspond with the real power consumption of the appliance.

# 6 Accessories

Use original accessories. These have been made especially for your appliance.

**Note:** Accessories may become deformed if they get hot. Deformation has no effect on function. As the accessory cools down, it will regain its original shape.

The accessories supplied may differ depending on the appliance model.

Accessories	Use
Wire rack	<ul style="list-style-type: none"> <li>■ Cake tins</li> <li>■ Ovenproof dishes</li> <li>■ Cookware</li> <li>■ Meat, e.g. roasting joints or steak</li> <li>■ Frozen meals</li> </ul>
Universal pan	<ul style="list-style-type: none"> <li>■ Moist cakes</li> <li>■ Baked items</li> <li>■ Bread</li> <li>■ Large roasts</li> <li>■ Frozen meals</li> <li>■ Catch dripping liquids, e.g. fat when grilling food on the wire rack.</li> </ul>
Meat thermometer	<p>High-precision roasting or cooking. → "Meat probe", Page 19</p>

### 6.1 Information on accessories

Some accessories are only suitable for certain types of heating.

#### Microwave accessories

The wire rack that is supplied is only suitable for operation solely using the microwave.  
Baking trays, e.g. the universal pan or the baking tray, may create sparks and are not suitable.  
Observe the information about the microwave.  
→ "Cookware and accessories with microwave", Page 16

### 6.2 Locking function

The locking function prevents the accessories from tilting when they are pulled out.  
You can pull out the accessories approximately halfway without them tipping. The accessories must be inserted into the cooking compartment correctly for the tilt protection to work properly.

### 6.3 Sliding accessories into the cooking compartment

Always slide the accessory into the cooking compartment the right way round. This is the only way to ensure that accessories can be pulled out approximately halfway without tipping.

1. Turn the accessories so that the notch **a** is at the rear and is facing downwards.
2. Insert the accessory between the two guide rods for a shelf position.

Wire rack Insert the wire rack with the open side facing the appliance door and the curved lip ~ facing downwards.

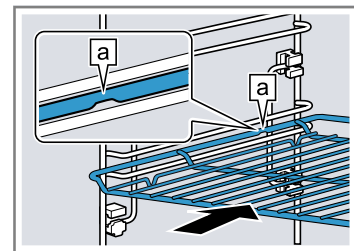

Baking tray E.g. universal pan or baking tray Slide the tray in with the sloping edge **b** towards the appliance door.

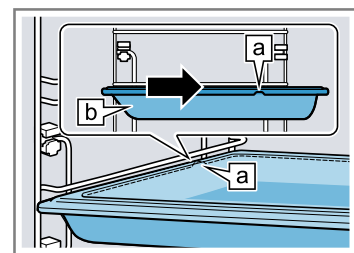

3. Push the accessory all the way in, making sure that it does not touch the appliance door.

**Note:** Take any accessories that you will not be using out of the cooking compartment while the appliance is in operation.

### 6.4 Other accessories

You can purchase other accessories from our after-sales service, specialist retailers or online. You will find a comprehensive range of products for your appliance in our brochures and online: [www.bosch-home.com](http://www.bosch-home.com)



Accessories vary from one appliance to another. When purchasing accessories, always quote the exact product number (E no.) of your appliance. You can find out which accessories are available for your appliance in our online shop or from our after-sales service.

## 7 Before using for the first time

Configure the settings for initial start-up. Clean the appliance and accessories.

### 7.1 Performing initial start-up

After connecting the appliance to the power supply, you must configure the settings for its initial start-up. It may take a few minutes for the settings to appear on the display.

1. Press  to switch the appliance on.
  - ✓ The first setting appears.
2. To change the setting as required, press a value in the list or change the value using the setting ring. Possible settings:
  - Language
  - Home Connect → "Home Connect ", Page 25
  - Time → "Setting the time", Page 24
3. Press  and switch to the next setting.
4. Work through the settings and make changes as required.
  - ✓ After the last setting, a message appears on the display confirming that the initial start-up is complete.
5. To check the appliance before heating for the first time, open and close the appliance door once.

### 7.2 Cleaning the appliance before using it for the first time

Before using the appliance to cook food for the first time, you must clean the cooking compartment and accessories.

1. Remove the product information and the accessories from the cooking compartment. Remove any leftover packaging, such as polystyrene pellets, and any adhesive tape that is in or on the appliance.
2. Wipe the smooth surfaces in the cooking compartment with a soft, damp cloth.
3. Press  to switch the appliance on.
4. Apply the following settings:

Type of heating	4D hot air 
Temperature	Maximum
Cooking time	1 hour

→ "Basic operation", Page 13

5. Start the operation.
  - Ventilate the kitchen while the appliance is heating.
  - ✓ When the time has elapsed, a signal sounds. A message appears on the display confirming that the operation has finished.
6. Press  to switch the appliance off.
7. Once the appliance has cooled down, clean the smooth surfaces in the cooking compartment with a detergent solution and a dish cloth.
8. Clean the accessories thoroughly using a detergent solution and a dish cloth or soft brush.

## 8 Basic operation

### 8.1 Switching on the appliance

- ▶ Press  to switch the appliance on.
- ✓ The display shows the menu.

### 8.2 Switching off the appliance

Switch your appliance off when you are not using it. The appliance will switch itself off automatically if it is not used for a certain period of time.

- ▶ Press  to switch the appliance off.
- ✓ The appliance switches off. Any functions currently in progress are cancelled.
- ✓ The time or residual heat indicator appears on the display.

### 8.3 Starting the operation

You must start each operation.



### ATTENTION!

If there is water on the cooking compartment floor when operating the appliance at temperatures above 120 °C, this will damage the enamel.

- ▶ Do not use the appliance if there is water on the cooking compartment floor.
- ▶ Wipe away any water on the cooking compartment floor before operation.
- ▶ Press  to start the operation.
- ✓ The settings appear on the display.

### 8.4 Interrupting the operation

You can interrupt the operation and then continue again.

1. To interrupt the operation, press .
2. Press  again to resume the operation.

### 8.5 Setting the operating mode

After you have switched on the appliance, the menu appears on the display.

1. To scroll through the various selection options, swipe to the left or right on the display.
  - Swipe right or left to scroll through the menu and other setting options.

- Swipe down or up to scroll through selection lists.
- 2. To select a function, press the function on the display.
- ✓ Depending on the function, possible setting values or other tiles are available for selection.
- 3. To go back to a setting if necessary, press ↶.
- 4. To change the setting values, use the digital setting ring:
  - Swipe over the setting ring clockwise or anti-clockwise, as required.
  - Or press a specific position on the setting ring.
- 5. Use ✓ to confirm the setting.
- 6. Press  $\begin{matrix} \text{start} \\ \text{stop} \end{matrix}$  to start the operation.
- 7. If the operation is ended:
  - If required, you can select other settings and re-start the operation.
  - When the food is ready, use ⏻ to switch the appliance off.

**Note:** You can save your settings as "Favourites" ☆ and use these again.

→ "Favourites", Page 22

## 8.6 Setting the type of heating and the temperature

1. Press "Types of heating" in the menu.
2. Press the type of heating that you want to use.
3. Press the temperature in °C or, depending on the type of heating, the setting.
4. Use the setting ring to set the temperature.
5. Press ✓ on the display to confirm the set temperature.

If required, you can implement additional settings:

- → "Rapid heating", Page 15
- → "Time-setting options", Page 15
- → "Microwave", Page 16
- → "Ventilation function 'Crisp Finish'", Page 18
- → "Meat probe", Page 19

6. Press  $\begin{matrix} \text{start} \\ \text{stop} \end{matrix}$  to start the operation.
- ✓ The appliance starts heating.
- ✓ The setting values and how long the appliance has already been in operation are shown on the display.
7. If the operation is ended:
  - If required, you can select other settings and re-start the operation.
  - When the food is ready, use ⏻ to switch the appliance off.

**Note:** The most suitable type of heating for your food can be found in the description of the type of heating.

→ "Types of heating", Page 10

## Changing the type of heating

When you change the type of heating, the other settings are also reset.

1. Press  $\begin{matrix} \text{start} \\ \text{stop} \end{matrix}$ .
2. Press ↶.
3. Press the type of heating that you want to use.
4. Reset the operation and use  $\begin{matrix} \text{start} \\ \text{stop} \end{matrix}$  to start.

## Changing the temperature

Once the operation has started, you can change the temperature at any time.

1. Press ^ on the display.
2. Press the temperature.
3. Change the temperature with the setting ring.
4. To confirm the change, press ✓ on the display.
- ✓ The change is applied.

## 8.7 Displaying information

In most cases, you can call up information about the function that you have just started. The appliance automatically displays certain information, e.g. to ask you to do/confirm something or to issue a warning.

1. Press ⓘ "Info".
- ✓ Information is displayed for a few seconds.
2. To scroll through lots of content in the message, swipe over the display.
3. If necessary, use ↶ to exit the message.

## 8.8 Sabbath-compliant use

If you want to operate your appliance so that it is Sabbath-compliant, use the time-setting options and change the basic setting for the lighting.

**Note:** If you open the appliance door during operation, the appliance stops heating. When you close the appliance door, the appliance continues to heat again. To operate your appliance so that it is Sabbath-compliant, do not open the appliance door until after operation.

1. Change the "Lighting" basic setting to "Always off".  
→ "Basic settings", Page 23  
This will ensure that the light in the cooking compartment is always off while the appliance is in operation and when you open the appliance door.
2. Set the required operating mode.  
→ "Setting the operating mode", Page 13  
→ "Setting the type of heating and the temperature", Page 14
3. Set the required cooking time depending on the operating mode.  
→ "Setting the cooking time", Page 15  
→ "Time-setting options", Page 15
4. Use "End time" to set the time at which the operation should end.  
→ "Setting the end time", Page 15  
→ "Time-setting options", Page 15
5. Place the food in the cooking compartment before the appliance starts to heat.
6. Press  $\begin{matrix} \text{start} \\ \text{stop} \end{matrix}$  to start the operation.
- ✓ The display shows the time remaining until the operation starts. The appliance is in standby mode.
- ✓ Once the start time has been reached, the appliance starts heating and the cooking time starts counting down.
7. When the operation has ended, remove the food from the cooking compartment. The appliance automatically switches off completely after approximately 15 to 20 minutes.

**Note:** If necessary, change the basic setting for the lighting again.

## 9 Rapid heating

To save time, rapid heating  can shorten the preheating time for set temperatures over 100 °C.



Rapid heating is possible for the following types of heating:

- 4D hot air 
- Top/bottom heating 



### 9.1 Setting rapid heating

To ensure an even cooking result, do not place the food in the cooking compartment until rapid heating has come to an end.

**Note:** Do not set a cooking time until rapid heating has come to an end.



1. Set a suitable type of heating and a temperature of at least 100 °C.  
Rapid heating automatically switches off at temperatures of 200 °C and above.
2. Press "Rapid heating".  
✓ The  symbol lights up red.
3. Press  to start the operation.  
✓ Rapid heating starts.  
✓ Once rapid heating has ended, a signal sounds. The  symbol changes back to white.
4. Place the food in the cooking compartment.

#### Cancelling rapid heating

1. Press  on the display.
2. Press "Rapid heating".  
✓ The  symbol changes back to white.

## 10 Time-setting options





For an operation, you can set the cooking time and the time at which the operation should be finished. The timer runs independently of the operation.

Time-setting option	Use
Cooking time 	If you set a cooking time, the appliance stops heating automatically once this time has elapsed.
End time 	Along with the cooking time, you can set the time at which you want the operation to end. The appliance starts up automatically so that the operation finishes at the required time.
Timer 	You can set the timer to run independently of the appliance during operation. It does not affect the appliance.

### 10.1 Setting the cooking time

You can set the cooking time for the operation up to 24 hours.



**Requirement:** An operating mode and temperature or level have been set.

1. Press  "Cooking time".
2. To set the cooking time, press the relevant time value, e.g. hour display "h" or minute display "m".  
✓ The selected value is marked in blue.
3. Use the setting ring to set the cooking time. If required, use  to reset the setting value.
4. To confirm the set cooking time, press  on the display.
5. Press  to start the operation.  
✓ The appliance starts to heat and the time counts down.  
✓ When the time has elapsed, a signal sounds. A message appears on the display confirming that the operation has finished.
6. Once the cooking time has elapsed:

- If required, you can select other settings and re-start the operation.
- When the food is ready, use  to switch the appliance off.





#### Changing the cooking time

You can change the cooking time at any time.

1. Press  on the display.
2. Press the cooking time .
3. Use the setting ring to change the cooking time.
4. To confirm the change, press  on the display.  
✓ The change is applied.

#### Cancelling the cooking time

You can cancel the cooking time at any time.

1. Press  on the display.
2. Press the cooking time .
3. Reset the cooking time using .  
**Note:** For operating modes that always require a cooking time, the appliance resets the cooking time to the preset value.
4. To confirm the change, press  on the display.  
✓ The change is applied.

### 10.2 Setting the end time





You can delay the time at which the cooking time for the operation is due to end by up to 24 hours.

#### Notes

- To achieve good cooking results, do not delay the time once the operation has already started.
- Food will spoil if you leave it in the cooking compartment for too long.



#### Requirements

- An operating mode and temperature or level have been set.
  - A cooking time is set.
1. Press  "End time".
  2. To set the time, press the hour display or the minute display.  
✓ The selected value is marked in blue.

3. Use the setting ring to delay the time.  
If required, use  to reset the setting value.
4. To confirm the set time, press  on the display.
5. Press  to start the operation.
  - ✓ The display shows the time remaining until the operation starts. The appliance is in standby mode.
  - ✓ Once the start time has been reached, the appliance starts heating and the cooking time starts counting down.
  - ✓ When the time has elapsed, a signal sounds. A notification appears on the display confirming that the operation has finished.
6. Once the cooking time has elapsed:
  - If required, you can select other settings and re-start the operation.
  - When the food is ready, use  to switch the appliance off.



### Changing the end time

To achieve good cooking results, only change the set time before the operation starts and before the cooking time starts counting down.

1. Press  on the display.
2. Press the end time .
3. Use the setting ring to change the end time.
4. To confirm the change, press  on the display.
  - ✓ The change is applied.

### Cancelling the end time

You can delete the set end time at any time.



1. Press  on the display.
2. Press the end time .
3. Use  to reset the end time.

**Note:** For operating modes that always require a cooking time, the appliance resets the time at which the cooking time ends to the next possible time.

4. To confirm the change, press  on the display.
  - ✓ The change is applied.



## 10.3 Setting the timer

The timer runs independently during the operation. You can set the timer for up to 24 hours. The timer has its own signal so that you can tell whether it is the timer or a cooking time that has elapsed.

1. Press .
2. To set the timer, press the relevant time value on the display, e.g. minute display "m" or second display "s".
  - ✓ The selected value is marked in blue.
3. Set the timer using the setting ring.  
If required, use  to reset the setting value.
4. To start the timer, press  on the display.
  - ✓ The timer counts down.
  - ✓ The timer remains visible on the display if the appliance is switched off.
  - ✓ When the appliance is switched on, the display shows the settings for the current operation. The timer is displayed in the status display.
  - ✓ Once the timer has elapsed, a signal sounds. A notification appears on the display confirming that the timer has finished.





### Changing the timer

You can change the timer at any time.

1. If the timer is running in the background, use  to select the timer beforehand.
2. Press .
3. Change the timer using the setting ring.
4. Press  to confirm.

### Cancelling the timer

You can cancel the timer at any time.

1. If the timer is running in the background, use  to select the timer beforehand.
2. Press .
3. Reset the timer using .
4. Press  to confirm.

## 11 Microwave

You can use the microwave to cook, heat up, bake or defrost food very quickly.

### 11.1 Cookware and accessories with microwave

To heat food evenly and avoid damaging your appliance, it is important to only use the right cookware and accessories.

Follow the cookware manufacturer's instructions.

Unless otherwise specified, place the cookware and accessory on level 2.

#### Microwave-safe cookware

Cookware made from heat-resistant, microwave-safe material:

- Glass
- Glass ceramic
- Porcelain
- Temperature-resistant plastic
- Fully glazed ceramic without cracks

- Serving dishes  
Only use cookware with decorative gold or silver trim if the manufacturer guarantees its suitability for microwave use.
- Supplied wire rack  
In microwave-only operation, sheets and trays, e.g. the universal pan or the baking tray, may create sparks and are not suitable.

These materials allow microwaves to pass through and are not damaged.

#### Cookware that is not microwave-safe

**Note:** Observe the specifications for preventing material damage.

→ "Microwave", Page 7

- Metal cookware and bakeware

Microwaves cannot pass through metal. The food is barely heated or not heated at all. Metal may create sparks in microwave-only operation.

## Cookware when adding microwave to an operating mode

If you switch on the microwave for another operating mode, metal is also an option, in addition to microwave-safe cookware and accessories:

- Metal cookware and bakeware
  - Metal must be kept at least 2 cm from the cooking compartment walls and the inside of the door.
  - Always place metal cookware or bakeware in the centre of the supplied wire rack.
- Accessories supplied:
  - Wire rack
  - Universal pan
  - Baking tray

## Testing cookware for microwave suitability

If you are unsure whether your cookware is suitable for use in the microwave, carry out a cookware test.

### ATTENTION!

Operating the appliance without food in the cooking compartment may lead to overloading.

- ▶ Do not switch on the microwave unless there is food inside. The only exception to this rule is when performing a short cookware test.

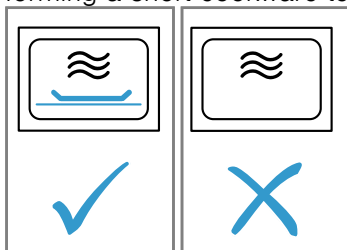

### ⚠ WARNING – Risk of burns!

The accessible parts of the appliance become hot during operation.

- ▶ Never touch these hot parts.
- ▶ Keep children at a safe distance.

1. Place the empty cookware in the cooking compartment.
2. Set the appliance to run for 30 seconds to 1 minute at maximum power.
3. Start the operation.
4. Check the cookware several times:
  - If the cookware remains cold or warm to the touch, it is suitable for microwave use.
  - If the cookware becomes hot or sparks are created, stop the cookware test. The cookware is not microwave-safe.

## 11.2 Setting options with the microwave

The microwave can be used on its own, or in combination with a different operating mode.

### Microwave-only operation

The electromagnetic waves of the microwave alone generate energy and this is converted into heat in food, for example.

To prevent condensation, when the microwave output is 600 watts and "Boost", the appliance automatically switches on a heating element. The cooking compartment and the accessories become hot. The cooking result is not affected by this.

You can switch off this automatic drying function in the basic settings.

→ "Basic settings", Page 23

### ⚠ WARNING – Risk of burns!

At the highest settings in microwave only mode, the drying function will automatically switch on an additional heating element to heat the cooking compartment.

- ▶ Never touch the inside surfaces of the cooking compartment or the heating elements while they are hot.
- ▶ Keep children at a safe distance.

### Added microwave

Adding the microwave to an operating mode reduces the cooking time.

You can combine the microwave with the following functions:

- Types of heating → Page 14
  - 4D hot air
  - Top/bottom heating
  - Circulated air grilling
  - Full-surface grill
  - Centre-area grill
- → "Dishes", Page 21
- → "Meat probe", Page 19
- → "Ventilation function 'Crisp Finish'", Page 18

Possible microwave outputs combined with an operating mode include:

- 90 watts
- 180 watts
- 360 watts

## 11.3 Setting the microwave

### Note:

Note the correct way to operate the microwave:

- → "Safety", Page 2
  - → "Preventing material damage", Page 6
  - → "Microwave output settings", Page 11
  - → "Cookware and accessories with microwave", Page 16
1. Press "Microwave" in the menu.
    - Or select the microwave directly using the button.
  2. Press the microwave output ("Boost").
  3. Use the setting ring to set the microwave output.
  4. To confirm the set microwave output, press on the display.
  5. Press "Cooking time".
    - A cooking time must always be set to operate the microwave.
  6. To change the preset cooking time, press the relevant time value, e.g. minute display "m" or second display "s".
    - ✓ The selected value is marked in blue.
  7. Use the setting ring to set the cooking time.
    - If required, use to reset the setting value.
  8. To confirm the set cooking time, press on the display.
  9. Press to start the operation.
    - ✓ The microwave starts and the cooking time counts down. The display shows the performance reduction for the maximum microwave output "Boost".
    - → "Microwave output settings", Page 11

## en Ventilation function "Crisp Finish"

- ✓ When the time has elapsed, a signal sounds. A notification appears on the display confirming that the operation has finished.

### 10. Once the cooking time has elapsed:

- If required, you can select other settings and re-start the operation.
- When the food is ready, use  to switch the appliance off.

- ### 11. If you have switched off the drying function for the microwave in the basic settings and condensation has formed in the cooking compartment, dry the cooking compartment.



→ "Drying", Page 30

**Note:** If you open the appliance door during operation, the operation stops. If you close the appliance door, you must continue the operation. If you have changed the basic setting for this, make sure that the microwave does not resume operation without food inside.

→ "Basic settings", Page 23



## Changing the microwave output

You can change the microwave output at any time.

1. Press  on the display.
  2. Press the microwave output .
  3. Use the setting ring to set the microwave output.
  4. To confirm the change, press  on the display.
- ✓ The change is applied.

## Changing the cooking time

You can change the cooking time at any time.

1. Press  on the display.
  2. Press the cooking time .
  3. Use the setting ring to change the cooking time.
  4. To confirm the change, press  on the display.
- ✓ The change is applied.

## 11.4 Setting added microwave

### Note:





Note the correct way to operate the microwave:

- → "Safety", Page 2

- → "Preventing material damage", Page 6
- → "Microwave output settings", Page 11
- → "Cookware and accessories with microwave", Page 16



**Requirement:** Observe the information about the respective operating mode.

→ "Setting options with the microwave", Page 17

1. Press the operating mode that you require in the menu.
  2. Select the settings for the operating mode, e.g. type of heating and temperature.
  3. Press  "Added microwave".
  4. Use the setting ring to set the microwave output.
  5. To confirm the set microwave output, press  on the display.
  6. Press  "Cooking time" and set the cooking time.
  7. Press  to start the operation.
- ✓ The appliance starts to heat and the time counts down.
  - ✓ When the time has elapsed, a signal sounds. A message appears on the display confirming that the operation has finished.
- ### 8. Once the cooking time has elapsed:
- If required, you can select other settings and re-start the operation.
  - When the food is ready, use  to switch the appliance off.

## Changing added microwave

You can change or deactivate the added microwave at any time.

1. Press  on the display.
  2. Press the microwave output .
  3. Change or deactivate added microwave with the setting ring.
  4. To confirm the change, press  on the display.
- ✓ The change is applied.

---





# 12 Ventilation function "Crisp Finish"

The ventilation function "Crisp Finish"  extracts moisture from the cooking compartment so that your food will be more crispy. Hot steam that may escape when the appliance door is opened is reduced.

## 12.1 Suitable types of heating with the ventilation function





Only certain types of heating are suitable for the ventilation function.

You can use the ventilation function for the following types of heating:

- 4D hot air 
- Top/bottom heating 
- Circulated air grilling 
- Pizza setting 

## 12.2 Setting the ventilation function

You can activate the ventilation function at any time, even after the start of the operation.

1. Set a suitable type of heating and a temperature. If required, you can select other settings and combine with the ventilation function.
2. Press  "Crisp Finish".
  - ✓ The  symbol lights up red.
3. Press  to start the operation.
  - ✓ The appliance starts heating.
  - ✓ The setting values are shown on the display.
4. When the food is ready, use  to switch the appliance off.

**Note:** Amplified fan noises can be heard while the appliance is in operation.

## Cancelling the ventilation function

You can switch off the ventilation function at any time.

1. Press  on the display.

2. Press  $\Rightarrow$  "Crisp Finish".
- ✓ The  $\Rightarrow$  symbol changes back to white.

- ✓ The operation continues without the ventilation function.

## 13 Meat probe

Cook with precision by inserting the meat probe  $\curvearrowright$  into the food and setting a core temperature on the appliance. The meat probe measures the core temperature inside the food. Once the set core temperature has been reached in the food, the appliance automatically stops heating.

### 13.1 Suitable types of heating with the meat probe

Only certain types of heating are suitable for use with the meat probe.

You can use the meat probe with the following types of heating:

- 4D hot air  $\text{Ⓢ}$
- Top/bottom heating  $\text{☐}$
- Gentle hot air  $\text{Ⓢ}$
- Gentle top/bottom heating  $\text{☐}$
- Circulated air grilling  $\text{Ⓢ}$
- Pizza setting  $\text{Ⓢ}$
- Slow cooking  $\text{☐}$
- Bottom heat  $\text{☐}$
- Keeping warm  $\text{Ⓢ}$

### 13.2 Inserting the meat probe

Use the meat probe supplied or order a suitable meat probe from our customer service.

#### **⚠ WARNING – Risk of electric shock!**

Using the wrong meat probe could damage the insulation.

- ▶ Only use the meat probe for this specific appliance.

#### **ATTENTION!**

Otherwise the meat probe may be damaged.

- ▶ Do not trap the cable of the meat probe.
- ▶ Do not use cookware with a lid.
- ▶ To prevent the meat probe from being damaged by excessive heat, there must be a gap of a few centimetres between the grill element and the meat probe. The meat may expand during the cooking process.

If, during operation with the microwave, the tip of the meat probe is not fully inside the food, sparks will be created.

- ▶ Insert the meat probe fully into the food.

#### **⚠ WARNING – Risk of injury!**

The meat probe is sharp.

- ▶ Handle the meat probe with care.

1. Insert the meat probe into the food.

The meat probe has three measuring points. Ensure that at least the middle measuring point is inserted in the food.

Thin pieces of meat	Insert the meat probe into the thickest part of the meat from the side.
---------------------	---

Thick pieces of meat

Insert the meat probe diagonally into the meat from above, pushing it in as far as possible.

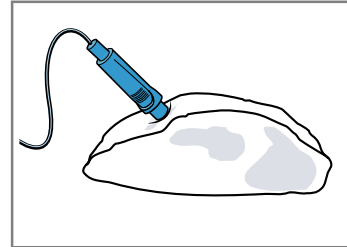

**Note:** If you want to turn the food, insert the meat probe into the side of the food so that it does not need to be removed when turning.

Poultry

Insert the meat probe into the thickest part of the breast, pushing it in as far as possible. The meat probe can be inserted horizontally or vertically depending on the size and shape of the poultry.

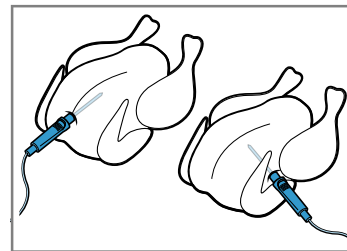

Turn the poultry and place it on the wire rack breast-side down.

Fish

When cooking whole fish, insert the meat probe behind the fish's head in the direction of the spine, pushing it in as far as possible.

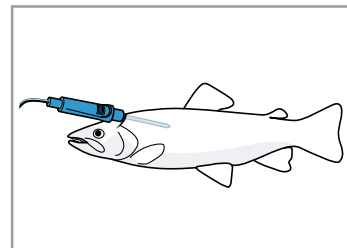

Place the fish on the wire rack in the swimming position without turning it, e.g. using half a potato as a support.

2. Place the food with the meat probe into the cooking compartment.
3. Plug the meat probe into the socket on the left-hand side of the cooking compartment.

**Note:** Do not remove the meat probe when turning the food. Once you have turned the food, check that the meat probe is correctly positioned in the food.

### 13.3 Setting the meat probe

You can set a core temperature of between 30 °C and 99 °C.

#### Requirements

- The food with the meat probe is in the cooking compartment.
- The meat probe is inserted in the cooking compartment.

1. Press "Types of heating" in the menu.
2. Press the type of heating that you want to use.
3. Press the temperature in °C.
4. Use the setting ring to set the cooking compartment temperature.

Set the cooking compartment temperature at least 10 °C higher than the core temperature.

Do not set the cooking compartment temperature to higher than 250 °C.

5. To confirm the set cooking compartment temperature, press ✓ on the display.
6. Press ↶ "Meat probe".
7. Use the setting ring to set the core temperature. If required, use ↺ to reset the setting value.
8. To confirm that you want to use the set core temperature, press ✓ on the display.
9. Press <sup>start</sup>/<sub>stop</sub> to start the operation.
- ✓ The appliance starts heating.
- ✓ The setting values and how long the appliance has already been in operation are shown on the display. If the appliance is connected to Home Connect, the forecast remaining time is displayed.
- ✓ Once the food reaches the core temperature, a signal sounds. A message appears on the display confirming that the operation has finished. The appliance stops heating. With the slow cooking type of heating, the appliance continues to heat.

#### 10. ⚠ **WARNING – Risk of burns!**

The cooking compartment, accessories and meat probe become very hot.

- ▶ Always use oven gloves to remove hot accessories and the meat probe from the cooking compartment.

When the core temperature is reached:

- If required, you can select other settings and restart the operation.
- When the food is ready, use ⏻ to switch the appliance off.
- Pull the meat probe out of the socket in the cooking compartment.
- Pull the meat probe out of the food and remove it from the cooking compartment.

#### Tips

- You can also combine the meat probe with a different operating mode, e.g.:
  - → "Microwave", Page 16
  - → "Dishes", Page 21
- You can use the meat probe even if no core temperature is set. You can read off the core temperature of the food on the display and manually end the operation, if required.

#### Changing the temperature

You can change the cooking compartment temperature and the core temperature at any time after starting the operation.

1. Press ^ on the display.
2. Press the cooking compartment temperature or core temperature.
3. Change the temperature with the setting ring.
4. To confirm the change, press ✓ on the display.

#### Changing the type of heating

When you change the type of heating, the other settings are also reset.

1. Press <sup>start</sup>/<sub>stop</sub>.
2. Press ↶.
3. Press the type of heating that you want to use.
4. Reset the operation and use <sup>start</sup>/<sub>stop</sub> to start.

### 13.4 Remaining time forecast for the operation

If your appliance is connected to Home Connect, the appliance can forecast the expected remaining time for the cooking process.

The initial remaining time appears on the display after approx. 1 minute. The remaining time is continually recalculated and updated.

**Note:** The remaining time forecast is not available for all types of heating.

### 13.5 Core temperatures of different foods

This is where you can find the suggested core temperatures for different foods.

These suggestions depend on the quality and the size/shape of the food. Do not use frozen food.

Poultry	Core temperature in °C
Chicken	80 - 85
Chicken breast	75 - 80
Duck	80 - 85
Duck breast, medium rare	55 - 60
Turkey	80 - 85
Turkey breast	80 - 85
Goose	80 - 90
Pork	Core temperature in °C
Shoulder of pork	85 - 90
Fillet of pork, medium rare	62 - 70
Pork loin, well done	72 - 80
Beef	Core temperature in °C
Tenderloin or sirloin, rare	45 - 52
Tenderloin or sirloin, medium rare	55 - 62
Tenderloin or sirloin, well done	65 - 75
Veal	Core temperature in °C
Joint of veal or hock, lean	75 - 80
Joint of veal, shoulder	75 - 80
Veal knuckle	85 - 90

Lamb	Core temperature in °C
Leg of lamb, medium rare	60 - 65
Leg of lamb, well done	70 - 80
Saddle of lamb, medium rare	55 - 60

Fish	Core temperature in °C
Fish, whole	65 - 70
Fish fillet	60 - 65
Other	Core temperature in °C
Meat loaf, all kinds of meat	80 - 90
Heating food, reheating	65 - 75

## 14 Dishes

The "Dishes" operating mode helps you to use your appliance to prepare different meals by selecting the optimum settings automatically.

### 14.1 Cookware for dishes

The cooking result depends on the composition of the meat and the size of cookware. You should therefore use heat-resistant cookware that is suitable for temperatures up to 300 °C. Glass or glass ceramic cookware is best. The joint should cover approx. 2/3 of the cookware base.

Cookware made from the following material is not suitable:

- Bright, shiny aluminium
- Unglazed clay
- Plastic or plastic handles

**Note:** For some dishes, the appliance switches on the microwave. A notification appears in the display stating that you should use cookware that is suitable for microwave use.

→ "Cookware and accessories with microwave", Page 16

### 14.2 Setting options for the dishes

To cook the dishes perfectly, the appliance uses different settings depending on the dish.

The display shows you the settings that are used. You can adjust certain settings. Follow the instructions on the display.

**Note:** The cooking result depends on the quality and composition of the food. Use fresh and, ideally, chilled food. Use frozen food straight from the freezer.

#### Tips and information about the settings

If you set a dish, the display shows relevant information for this dish, e.g.:

- Suitable shelf position
- Suitable accessory or cookware
- Added liquid
- Time for turning or stirring

When this time is reached, a signal sounds.

To call up the information, press ⓘ "Info". Some messages are displayed automatically.

#### Programmes

The optimum type of heating, temperature and cooking time are preset for programmes.

To achieve an optimal cooking result, you must also set the weight, thickness or the cooking level. You can set the weight only in the intended range.

Unless otherwise indicated, set the total weight for your dish.

#### Recommended settings

For the recommended settings, the optimum type of heating is preset as a fixed value.

You can adjust the preset temperature and the cooking time.

#### Baking sensor

Some dishes are suitable for cooking with the baking sensor (👤). You do not have to implement any further settings.

The baking sensor monitors the baking process in the cooking compartment. The appliance regulates the settings automatically and ends the operation once the dish is ready.

#### Notes

- Do not use the baking sensor if the dish is already pre-baked. The baking result would no longer be satisfactory.
- Do not open the appliance door approx. 5 minutes after starting the operation with the baking sensor. The baking sensor mode stops. If you have to open the appliance door, restart the operation afterwards without the baking sensor or cancel the operation and set it manually. Monitor the cooking process until the food is ready.
- To achieve an optimal baking result, use dark-coloured metal baking tins.

#### ATTENTION!

Using silicone moulds or any film, covers or accessories that contain silicone could damage the baking sensor. Damage may occur even if the baking sensor is not active.

- ▶ Do not use silicone moulds or any film, covers or accessories that contain silicone.
- ▶ Never place objects made of silicone in the cooking compartment.

#### Remaining time forecast for the operation

If your appliance is connected to Home Connect, the appliance can forecast the expected remaining time for the cooking process.

The initial remaining time appears on the display after approx. 1 minute. The remaining time is continually recalculated and updated.

**Note:** The remaining time forecast is not available for all types of heating.

### 14.3 Overview of the dishes

You can find out which individual dishes are available to you on the appliance when you call up the operating mode. The selection of dishes depends on the features of your appliance.

The dishes are sorted by category and food.



**Note:** In the basic settings, you can regionally specialise the displayed dishes.

→ "Basic settings", Page 23

Category	Food
Baking sensor	Cakes Small baked items Bread, bread rolls Savoury cakes, pizza, quiche <b>Note:</b> This only contains dishes for cooking with the baking sensor.
Cakes	Cakes in tins Cakes on a baking tray Small baked items Biscuits
Bread, bread rolls	Bread Bread rolls
Pizza, savoury cakes	Pizza Savoury cakes, quiche
Bakes, soufflés	Bake, savoury, fresh, cooked ingredients Potato gratin, raw ingredients, 4 cm deep Fresh lasagne Lasagne, chilled Bake, sweet, fresh Fruit crumble Soufflés in individual moulds Yorkshire pudding
Poultry	Chicken Duck, goose Turkey
Meat	Pork Beef Veal Lamb Game Meat dishes
Fish.	Fish, whole Fish fillet
Frozen products	Pizza Bakes Potato products Poultry, fish Bread rolls

Category	Food
Side dishes, vegetables	Potatoes Rice Cereals Vegetables
Defrosting food	Cakes Bread, bread rolls Meat, poultry Fish

### 14.4 Setting a dish

1. Press "Dishes" in the menu.
2. Press the required category.
3. Press the required food.
4. Press the required dish.  
**Tip:** For some dishes, you can select a preferred cooking method.  
→ "Setting options for the dishes", Page 21
- ✓ The settings for the dish appear on the display.
5. Adjust the settings if required.  
You can adjust only certain settings depending on the dish.  
→ "Setting options for the dishes", Page 21
6. For information about the accessory and shelf position, for example, press  "Info".
7. Press  to start the operation.  
✓ The appliance starts to heat and the time counts down.  
✓ No cooking time is displayed in baking sensor mode. The setting values and how long the appliance has already been in operation are shown on the display. If the appliance is connected to Home Connect, the forecast time remaining is displayed.  
→ "Remaining time forecast for the operation", Page 21
- ✓ Once the dish is ready, a signal sounds. The appliance stops heating.
8. Once the cooking time has elapsed:
  - If required, you can select other settings and re-start the operation.
  - When the food is ready, use  to switch the appliance off.

### 14.5 Automatic switch-off function

The automatic switch-off function  for the dishes allows you to bake and fry without any stress.

When the operation has finished, the appliance automatically stops heating.

To achieve an optimum cooking result, remove your dish from the cooking compartment once the operation has finished.

## 15 Favourites

In the "Favourites", you can save your settings and use these again.

**Note:** Depending on the appliance type/software status, you must first download this function to your appliance. You can find more information in the Home Connect app.

## 15.1 Saving favourites

You can save up to 30 different operating modes as your favourites.

- ▶ If you set an operating mode, at the end of the selection list, press ☆ "Save as favourites".  
To rename a favourite, you must use the Home Connect app. When your appliance is connected, follow the instructions in the app.

## 15.2 Selecting favourites

If you have saved favourites, you can use these to set the operation.

1. Press "Favourites" in the menu.
    - Or select the favourites directly using the ☆ button.
  2. Press the required favourites.
  3. If required, you can change the settings.
  4. Press  $\begin{smallmatrix} \text{start} \\ \text{stop} \end{smallmatrix}$  to start the operation.
- ✓ The setting values are shown on the display.

### Note:

Observe the instructions for the various operating modes:

- → "Microwave", Page 16
- → "Ventilation function 'Crisp Finish'", Page 18
- → "Meat probe", Page 19

## 15.3 Changing favourites

You can change, sort or delete your saved favourites at any time.

1. To sort or rename the favourites, you must use the Home Connect app. When your appliance is connected, follow the instructions in the app.
2. To change the setting values on the appliance, press "Favourites" in the menu.
  - Or select the favourites directly using the ☆ button.
3. Press the required favourites.
4. At the end of the selection list, press  $\begin{smallmatrix} \text{edit} \\ \text{cancel} \end{smallmatrix}$  "Edit favourite"
5. Change the setting values.
6. Confirm the change.

### Deleting favourites

1. To delete a favourite, press "Favourites" in the menu.
  - Or select the favourites directly using the ☆ button.
2. Press the required favourites.
3. At the end of the selection list, press  $\begin{smallmatrix} \text{delete} \\ \text{cancel} \end{smallmatrix}$  "Delete favourite"
4. Confirm the deletion.

# 16 Childproof lock

You can secure your appliance to prevent children from accidentally switching it on or changing the settings.

## 16.1 Activating the childproof lock

The childproof lock can be activated regardless of whether the appliance is on or off.

- ▶ Press and hold  $\infty$  for approx. 4 seconds to activate the childproof lock.
- ✓ A confirmation message appears on the display.
- ✓ The control panel is locked. The appliance can only be switched off using  $\odot$ .

- ✓ When the appliance is switched on,  $\infty$  lights up. When the appliance is switched off,  $\infty$  does not light up.

## 16.2 Deactivating the childproof lock

You can deactivate the childproof lock at any time.

1. Press anywhere on the display.
  2. To deactivate the childproof lock:
    - Follow the instructions on the display so that the graphic on the ring fills up completely.
    - Alternatively, press and hold  $\infty$  for approximately 4 seconds.
- ✓ A confirmation message appears on the display.

# 17 Basic settings

You can configure the basic settings for your appliance to meet your needs.

## 17.1 Overview of the basic settings

Here you can find an overview of the basic settings and factory settings. The basic settings depend on the features of your appliance.

You can find more information about the individual basic settings on the display using  $\text{Info}$  "Info".

Basic settings	Selection
Language	See selection on the appliance.

Basic settings	Selection
Home Connect	Connect the oven to a mobile device and remotely control it. → "Home Connect", Page 25
Time	Time in 24-hour format.

Display	Selection
Brightness	<ul style="list-style-type: none"> <li>■ Levels 1, 2, 3, 4 and 5<sup>1</sup></li> </ul>
Standby screen	<ul style="list-style-type: none"> <li>■ On for a limited time</li> <li>■ On (this setting increases energy consumption)</li> <li>■ Off<sup>1</sup></li> </ul>

<sup>1</sup> Factory setting (may vary according to model)

Display	Selection
Clock	<ul style="list-style-type: none"> <li>▪ Digital<sup>1</sup></li> <li>▪ Analogue</li> </ul>
Alignment	<ul style="list-style-type: none"> <li>▪ Align the display horizontally and vertically.</li> </ul>

<sup>1</sup> Factory setting (may vary according to model)

Tone	Selection
Button tone	<ul style="list-style-type: none"> <li>▪ On<sup>1</sup></li> <li>▪ Off</li> </ul>
Signal tone	<ul style="list-style-type: none"> <li>▪ Very short duration (once)</li> <li>▪ Short duration (approx. 5 seconds)</li> <li>▪ Medium duration (approx. 10 seconds)<sup>1</sup></li> <li>▪ Long duration (approx. 30 seconds)</li> </ul>

<sup>1</sup> Factory setting (may vary according to model)

Appliance settings	Selection
Fan run-on time	<ul style="list-style-type: none"> <li>▪ Minimum</li> <li>▪ Recommended<sup>1</sup></li> <li>▪ Long</li> <li>▪ Very long</li> </ul>
Lighting	<ul style="list-style-type: none"> <li>▪ When cooking and when the door is opened<sup>1</sup></li> <li>▪ Only when the door is opened</li> <li>▪ Always off</li> </ul>
Microwave output presetting	<ul style="list-style-type: none"> <li>▪ 90 W</li> <li>▪ 180 W</li> <li>▪ 360 W</li> <li>▪ 600 W</li> <li>▪ Boost<sup>1</sup></li> </ul>
Continue to microwave	<ul style="list-style-type: none"> <li>▪ Off<sup>1</sup></li> <li>▪ On</li> </ul>
Dry microwave	<ul style="list-style-type: none"> <li>▪ On<sup>1</sup></li> <li>▪ Off</li> </ul>

<sup>1</sup> Factory setting (may vary according to model)

Personalisation	Selection
Brand logo	<ul style="list-style-type: none"> <li>▪ Display<sup>1</sup></li> <li>▪ Do not display</li> </ul>
Operation after switch-on	<ul style="list-style-type: none"> <li>▪ Main menu<sup>1</sup></li> <li>▪ Types of heating</li> <li>▪ Microwave</li> <li>▪ Dishes</li> <li>▪ Favourites</li> </ul>
Elapsed cooking time	<ul style="list-style-type: none"> <li>▪ Do not display</li> <li>▪ Display<sup>1</sup></li> </ul>
Microwave baking tray	<ul style="list-style-type: none"> <li>▪ On<sup>1</sup></li> <li>▪ Off</li> </ul>

<sup>1</sup> Factory setting (may vary according to model)

Personalisation	Selection
Regional dishes	<ul style="list-style-type: none"> <li>▪ All<sup>1</sup></li> <li>▪ European dishes</li> <li>▪ British dishes</li> </ul>

Dishes	<ul style="list-style-type: none"> <li>▪ All<sup>1</sup></li> <li>▪ No pork</li> <li>▪ Kosher only</li> </ul>
--------	---

Childproof lock	<ul style="list-style-type: none"> <li>▪ Door lock + keylock</li> <li>▪ Button lock only<sup>1</sup></li> <li>▪ Deactivated</li> </ul>
-----------------	--

Automatic rapid heating	<ul style="list-style-type: none"> <li>▪ off</li> <li>▪ On<sup>1</sup></li> </ul>
-------------------------	---

<sup>1</sup> Factory setting (may vary according to model)

Factory settings	Selection
Factory settings	<ul style="list-style-type: none"> <li>▪ Restore</li> </ul>

Info	Display
Appliance information	Display technical information about the appliance.

## 17.2 Changing the basic settings

1. Press "Basic settings" in the menu.
2. Press the required basic settings area.
3. Press the required basic setting.
4. Press to select the required basic setting.
  - ✓ The change is applied directly for most basic settings.
5. To change additional basic settings, use ↵ to go back and select a different basic setting.
6. To exit the basic settings, use ⏪ to go back to the main menu or switch off the appliance using ⏻.
  - ✓ The changes are saved.

**Note:** Your changes to the basic settings will be retained even after a power failure.

## 17.3 Setting the time

1. Press "Basic settings" in the menu.
2. Press "Time".
3. To set the time, press the hour display or the minute display.
  - ✓ The selected value is marked in blue.
4. Use the setting ring to set the time.
  - The minutes are counted in 5-minute increments. To set it to the precise minute, press and hold the corresponding area in the setting ring for around 1-2 seconds. The minutes are shown in dots. Use the setting ring to set the minutes.
5. To exit the basic settings, use ⏪ to go back to the main menu or switch off the appliance using ⏻.
  - ✓ The time is saved.

## 18 Home Connect

This appliance is network-capable. Connecting your appliance to a mobile device lets you control its functions via the Home Connect app, adjust its basic settings and monitor its operating status.

The Home Connect services are not available in every country. The availability of the Home Connect function depends on the availability of Home Connect services in your country. You can find information about this at: [www.home-connect.com](http://www.home-connect.com).

The Home Connect app guides you through the entire login process. Follow the instructions in the Home Connect app to configure the settings.

### Tips

- Please consult the documents supplied by Home Connect.
- Please also follow the instructions in the Home Connect app.

### Notes

- Please note the safety precautions in this instruction manual and make sure that they are also observed when operating the appliance via the Home Connect app.  
→ "Safety", Page 2
- Operating the appliance on the appliance itself always takes priority. During this time it is not possible to operate the appliance using the Home Connect app.
- In networked standby mode, the appliance requires a maximum of 2 W.

### 18.1 Setting up Home Connect

#### Requirements

- The appliance is connected to the power supply and is switched on.
- You have a mobile device with a current version of the iOS or Android operating system, e.g. a smartphone.
- The mobile device and the appliance are within range of your home network's Wi-Fi signal.

1. Download the Home Connect app.



1

<sup>1</sup> Apple App Store and the Apple App Store logo are trademarks of Apple Inc. Google Play and the Google Play logo are trademarks of Google LLC.

2. Open the Home Connect app and scan the following QR code.



3. Follow the instructions in the Home Connect app.

### 18.2 Home Connect settings

You can adjust the Home Connect settings and network settings in your appliance's basic settings. Which settings the display shows will depend on whether Home Connect has been set up and whether the appliance is connected to your home network.

Basic setting	Possible settings	Explanation
Home Connect assistant	Start the assistant Disconnect	You can connect your appliance to the Home Connect app via the Home Connect assistant. <b>Note:</b> If you are using the Home Connect assistant for the first time, only the "Start assistant" setting is available.

Basic setting	Possible settings	Explanation
Wi-Fi	On Off	You can use the Wi-Fi to switch off the network connection for your appliance. When you have connected successfully once, you can deactivate the Wi-Fi and not lose your detailed data. As soon as you activate Wi-Fi again, the appliance connects automatically. <b>Note:</b> In networked standby mode, the appliance requires a maximum of 2 W.
Remote control status	Monitoring Manual remote start Permanent remote start	During monitoring, you can only view the operating status of the appliance in the app. For manual remote start, you must activate the remote start each time before you can start the appliance via the app. You can open the appliance door within 15 minutes of having activated remote start. Remote start will not be deactivated by this. Once 15 minutes have elapsed, opening the appliance door will deactivate manual remote start. For permanent remote start, you can start and operate the appliance remotely at any time. If you often operate the appliance remotely, it is helpful to set the remote start to "Permanent".

### 18.3 Operating the appliance with the Home Connect app

You can use the Home Connect app to set and start the appliance remotely.

#### **⚠ WARNING – Risk of fire!**

Combustible objects that are left in the cooking compartment may catch fire.

- ▶ Never store combustible objects in the cooking compartment.
- ▶ If smoke is emitted, the appliance must be switched off or the plug must be pulled out and the door must be held closed in order to stifle any flames.

#### **Requirements**

- The appliance is switched on.
- The appliance is connected to the home network and to the Home Connect app.
- In order to be able to set the appliance via the app, the manual or permanent remote start must be selected in the "Remote control status" basic setting.

1. To activate remote start, press .
2. Configure a setting in the Home Connect app and send it to the appliance.

#### **Notes**

- When you start the oven using the controls on the appliance itself, the remote start function is activated automatically. You can use the Home Connect app to adjust the settings or start a new programme.
- You can open the appliance door within 15 minutes of having activated remote start. Remote start will not be deactivated by this. Once 15 minutes have elapsed, opening the appliance door will deactivate manual remote start.

### 18.4 Software update

Your appliance's software can be updated using the software update function, e.g. for the purposes of optimisation, troubleshooting or security updates. To do this, you must be a registered Home Connect user, have installed the app on your mobile device and be connected to the Home Connect server.

As soon as a software update is available, you will be informed via the Home Connect app and will be able to start the software update via the app. Once the update has been successfully downloaded, you can start installing it via the Home Connect app if you are in your home network (Wi-Fi). The Home Connect app informs you once installation is successful.

#### **Notes**

- The software update consists of two steps.
  - The first step is the download.
  - The second step is the installation on your appliance.
- You can continue to use your appliance as normal while updates are downloading. Depending on your personal settings in the app, software updates can also be set to download automatically.
- Installation takes a few minutes. You cannot use your appliance during installation.
- We recommend that you install security updates as soon as possible.

### 18.5 Remote diagnostics

Customer Service can use Remote Diagnostics to access your appliance if you contact them, have your appliance connected to the Home Connect server and if Remote Diagnostics is available in the country in which you are using the appliance.

**Tip:** For further information and details about the availability of Remote Diagnostics in your country, please visit the service/support section of your local website: [www.home-connect.com](http://www.home-connect.com).

### 18.6 Data protection

Please see the information on data protection.

The first time your appliance is registered on a home network connected to the Internet, your appliance will transmit the following types of data to the Home Connect server (initial registration):

- Unique appliance identification (consisting of appliance codes as well as the MAC address of the Wi-Fi communication module installed).
- Security certificate of the Wi-Fi communication module (to ensure a secure data connection).

- The current software and hardware version of your appliance.
- Status of any previous reset to factory settings.

This initial registration prepares the Home Connect functions for use and is only required when you want to use the Home Connect functions for the first time.

**Note:** Please note that the Home Connect functions can only be utilised with the Home Connect app. Information on data protection can be retrieved in the Home Connect app.

## 19 Cleaning and servicing

To keep your appliance working efficiently for a long time, it is important to clean and maintain it carefully.

### 19.1 Cleaning products

In order to avoid damaging the various oven surfaces on the appliance, do not use unsuitable cleaning products.

#### **⚠ WARNING – Risk of electric shock!**

An ingress of moisture can cause an electric shock.

- ▶ Do not use steam- or high-pressure cleaners to clean the appliance.

#### **ATTENTION!**

Unsuitable cleaning agents damage the surfaces of the appliance.

- ▶ Do not use harsh or abrasive cleaning products.
- ▶ Do not use cleaning products with a high alcohol content.

- ▶ Do not use hard scouring pads or cleaning sponges.
- ▶ Do not use any special cleaners for cleaning the appliance while it is hot.

Using oven cleaner in a hot cooking compartment damages the enamel.

- ▶ Never use oven cleaner in the cooking compartment when it is still warm.
- ▶ Remove all food remnants from the cooking compartment and the appliance door before you next heat up the appliance.

If different cleaning agents are mixed together, there may be a chemical reaction between these.

- ▶ Do not mix cleaning agents.
- ▶ Completely remove any cleaning agent residue. Salt contained in new sponge cloths may damage surfaces.
- ▶ Wash new sponge cloths thoroughly before use.

### Suitable cleaning agents

Only use cleaning agents that are suitable for the different surfaces on your appliance.

Follow the instructions on cleaning the appliance.  
→ "Cleaning the appliance", Page 28

#### Appliance front

Surface	Suitable cleaning agents	Information
Stainless steel	<ul style="list-style-type: none"> <li>■ Hot soapy water</li> <li>■ Special stainless steel cleaning products suitable for hot surfaces</li> </ul>	To prevent corrosion, remove any patches of limescale, grease, starch or albumin (e.g. egg white) from stainless steel surfaces immediately. Apply a thin layer of the stainless steel cleaning product.
Plastic or painted surfaces E.g. control panel	<ul style="list-style-type: none"> <li>■ Hot soapy water</li> </ul>	Do not use glass cleaner or a glass scraper. To avoid permanent stains, immediately remove any descaling agent that gets onto the surface.

#### Appliance door

Area	Suitable cleaning agents	Information
Door panels	<ul style="list-style-type: none"> <li>■ Hot soapy water</li> <li>■ Oven cleaners</li> </ul>	Do not use a glass scraper or stainless steel wool. <b>Tip:</b> Remove the door panels in order to clean them thoroughly. → "Appliance door", Page 31
Door cover	<ul style="list-style-type: none"> <li>■ Made of stainless steel: Stainless steel cleaner</li> <li>■ Made from plastic: Hot soapy water</li> </ul>	Do not use glass cleaner or a glass scraper. Do not use stainless steel care products. <b>Tip:</b> Remove the door cover for thorough cleaning. → "Appliance door", Page 31
Stainless steel interior door frame	<ul style="list-style-type: none"> <li>■ Stainless steel cleaner</li> </ul>	Discolouration can be removed using stainless steel cleaner. Do not use stainless steel care products.

Area	Suitable cleaning agents	Information
Door handle	<ul style="list-style-type: none"> <li>▪ Hot soapy water</li> </ul>	To avoid permanent stains, immediately remove any descaling agent that gets onto the surface.
Door seal	<ul style="list-style-type: none"> <li>▪ Hot soapy water</li> </ul>	Do not remove or scrub.

### Cooking compartment

Area	Suitable cleaning agents	Information
Enamel surfaces	<ul style="list-style-type: none"> <li>▪ Hot soapy water</li> <li>▪ Vinegar water</li> <li>▪ Oven cleaners</li> </ul>	<p>Soak any heavily soiled areas and use a brush or steel wool. Leave the appliance door open to dry the cooking compartment after cleaning it.</p> <p><b>Notes</b></p> <ul style="list-style-type: none"> <li>▪ It is best to use the cleaning function. → "Pyrolytic activeClean cleaning function", Page 28</li> <li>▪ Enamel burns at very high temperatures, causing minor discoloration. The functionality of your appliance is not affected by this.</li> <li>▪ The edges of thin trays cannot be completely enamelled and may be rough. This does not impair the corrosion protection.</li> <li>▪ Food residues leave a white coating on the enamel surfaces. The coating does not pose a health risk. The functionality of your appliance is not affected by this. You can remove residues with lemon juice.</li> </ul>
Shelf supports	<ul style="list-style-type: none"> <li>▪ Hot soapy water</li> </ul>	<p>Soak any heavily soiled areas and use a brush or steel wool.</p> <p><b>Note:</b> To clean thoroughly, detach the shelf supports. → "Rails", Page 32</p>
Accessories	<ul style="list-style-type: none"> <li>▪ Hot soapy water</li> <li>▪ Oven cleaners</li> </ul>	<p>Soak any heavily soiled areas and use a brush or steel wool. Enamelled accessories are dishwasher-safe.</p>
Meat probe	<ul style="list-style-type: none"> <li>▪ Hot soapy water</li> </ul>	<p>Use a brush to remove heavy soiling. Do not clean in the dishwasher.</p>

## 19.2 Cleaning the appliance

In order to avoid damaging the appliance, you must clean your appliance only as specified, and with suitable cleaning products.

### **WARNING – Risk of burns!**

The appliance and its parts that can be touched become hot during use.

- ▶ Caution should be exercised here in order to avoid touching heating elements.
- ▶ Young children under 8 years of age must be kept away from the appliance.

### **WARNING – Risk of fire!**

Loose food remnants, fat and meat juices may catch fire.

- ▶ Before using the appliance, remove the worst of the food residues and remnants from the cooking compartment, heating elements and accessories.

**Requirement:** Read the information on cleaning products.

→ "Cleaning products", Page 27

1. Clean the appliance using hot soapy water and a dish cloth.
  - For some surfaces, you can use alternative cleaning agents.  
→ "Suitable cleaning agents", Page 27
2. Dry with a soft cloth.

# 20 "Pyrolytic activeClean" cleaning function

With the "Pyrolytic activeClean"  cleaning function, the cooking compartment is cleaned virtually automatically. Use the cleaning function to clean the cooking compartment every two to three months. You can use the cleaning function more often, if required. The cleaning function requires approx. 3.9 - 4.8 kilowatt hours.

## 20.1 Preparing the appliance for the cleaning function

To achieve a good cleaning result and prevent damage, prepare the appliance carefully.

**⚠ WARNING – Risk of fire!**

Combustible objects that are left in the cooking compartment may catch fire.

- ▶ Never store combustible objects in the cooking compartment.
- ▶ If smoke is emitted, the appliance must be switched off or the plug must be pulled out and the door must be held closed in order to stifle any flames.

Loose food remnants, fat and meat juices may catch fire when the cleaning function is in progress.

- ▶ Before you start the cleaning function, always remove coarse dirt from the cooking compartment.
  - ▶ Never clean accessories at the same time.
- The outside of the appliance gets very hot when the cleaning function is in progress.
- ▶ Never hang combustible objects, e.g. tea towels, on the door handle.
  - ▶ Leave the front of the appliance clear.
  - ▶ Keep children at a safe distance.

If the door seal is damaged, a large amount of heat is generated around the door.

- ▶ Do not scrub or remove the seal.
  - ▶ Never operate the appliance if the seal is damaged or missing.
1. Remove accessories and cookware from the cooking compartment.  
You can also clean the shelf supports.
  2. Remove coarse dirt from the cooking compartment and from the shelf supports.
  3. Use a detergent solution and a soft cloth to clean the surfaces at the edges of the cooking compartment around the door seal.  
Do not remove or scrub the door seal.  
Use oven cleaner to remove stubborn dirt from the inner door pane.
  4. Remove any objects from the cooking compartment.  
The cooking compartment must be empty except for the shelf supports.

**20.2 Setting the cleaning function**

Ventilate the kitchen while the cleaning function is running.

**⚠ WARNING – Risk of harm to health!**

The cleaning function heats up the cooking compartment to a very high temperature so that food left over from roasting, grilling and baking will burn off. This process releases vapours, which can irritate mucous membranes.

- ▶ Keep the kitchen well ventilated while the cleaning function is running.
- ▶ Do not remain in the room for long periods.
- ▶ Keep children and pets away.

**⚠ WARNING – Risk of burns!**

The cooking compartment gets very hot when the cleaning function is in progress.

- ▶ Never open the appliance door.
- ▶ Allow the appliance to cool down.
- ▶ Keep children at a safe distance.

**⚠** The outside of the appliance gets very hot when the cleaning function is in progress.

- ▶ Never touch the appliance door.
- ▶ Allow the appliance to cool down.
- ▶ Keep children at a safe distance.

**Note:** The oven light does not light up while the cleaning function is running.



**Requirement:** → "Preparing the appliance for the cleaning function", Page 28.

1. Press "Cleaning" in the menu.
2. Press  "Pyrolytic activeClean".
3. Press "Level" and use the setting ring to set the cleaning setting.

Cleaning setting	Cleaning level	Duration in hours
1	Low	Approx. 2:15
2	High	Approx. 2:30

The duration cannot be changed.  
You can delay the time at which the operation should be ready.

→ "Setting the end time", Page 15

4. To confirm the set cleaning setting, press ✓ on the display.
5. Press .
- ✓ A notification stating that you should carry out the necessary preparatory work for the cleaning function appears on the display.
6. Confirm the message.
- ✓ The cleaning function starts and the duration counts down.
- ✓ For your safety, the appliance door locks once a certain temperature is reached in the cooking compartment.  appears on the display.
- ✓ A signal tone sounds when the cleaning function has finished. A message appears on the display confirming that the operation has finished.
7. Press  to switch the appliance off.
8. → "Preparing the appliance after the cleaning function", Page 29.

**Cancelling the cleaning function**

You can no longer stop or change the cleaning function once it has started.

- ▶ To cancel the cleaning function, press  to switch the appliance off.

**20.3 Preparing the appliance after the cleaning function**

1. Allow the appliance to cool down.
2. Wipe off any ash that has been left behind in the cooking compartment, on the shelf supports and around the appliance door with a damp cloth.
3. Remove white residues with lemon juice.

**Note:** White residues on the enamel surfaces may be caused by heavy soiling. These food residues are harmless. The deposits do not compromise the functionality of the appliance.

**Note:** While the cleaning function is running, the frame on the inside of the appliance door or other parts of the door that are made of stainless steel become discoloured. This discolouration does not compromise the functionality of the appliance. The discolouration can be removed using a stainless steel cleaner.

## 21 Cleaning aid

The cleaning aid  is a quick alternative for occasionally cleaning the cooking compartment. The cleaning aid softens dirt by evaporating the soapy water. It is then easier to remove the dirt.

### 21.1 Setting the cleaning aid



#### **WARNING – Risk of scalding!**

If there is water in the cooking compartment when it is hot, this may create hot steam.

- ▶ Never pour water into the cooking compartment when the cooking compartment is hot.

**Note:** The oven light does not come on while the cleaning aid is running.

**Requirement:** The cooking compartment must have cooled down completely.

1. Remove any accessories from the cooking compartment.
  2. **ATTENTION!**  
Distilled water in the cooking compartment leads to corrosion.
    - ▶ Do not use distilled water.
 Mix 0.4 litres water with a drop of washing-up liquid and pour into the centre of the cooking compartment floor.
  3. Press "Cleaning" in the menu.
  4. Press  "Cleaning aid".  
The duration cannot be changed.
  5. Press .
- ✓ A notification stating that you should carry out the necessary preparatory work for the cleaning aid appears on the display.

6. Confirm the message.
  - ✓ The cleaning aid starts and the duration counts down.
  - ✓ Once the cleaning aid has ended, a signal tone sounds. A message appears on the display confirming that the operation has finished.
7. Press  to switch the appliance off.
8. → "Cleaning the cooking compartment after using the cleaning aid", Page 30.

### 21.2 Cleaning the cooking compartment after using the cleaning aid

#### **ATTENTION!**

The prolonged presence of moisture in the cooking compartment leads to corrosion.

- ▶ After using the cleaning assistance, wipe the cooking compartment and allow it to dry completely.
1. Allow the appliance to cool down.
  2. Wipe out the remaining water in the cooking compartment using an absorbent sponge cloth.
  3. Clean the smooth enamel surfaces in the cooking compartment with a dish cloth or a soft brush. Remove stubborn food remnants using a stainless steel scouring pad.
  4. Remove limescale with a cloth soaked in vinegar, and wipe this away with clean water.
  5. Dry the cooking compartment with a soft cloth.
  6. To dry the cooking compartment completely, leave the appliance door open for approx. 1 hour or use the drying function.  
→ "Setting the drying process", Page 30

## 22 Drying

To prevent residual moisture, dry the cooking compartment following microwave-only operation and after using the cleaning aid.

#### **ATTENTION!**

If there is water on the cooking compartment floor when operating the appliance at temperatures above 120 °C, this will damage the enamel.

- ▶ Do not use the appliance if there is water on the cooking compartment floor.
- ▶ Wipe away any water on the cooking compartment floor before operation.

### 22.1 Drying the cooking compartment



You can leave the cooking compartment to dry or use the drying function.

1. Allow the appliance to cool down.
2. Remove any dirt from the cooking compartment.
3. Wipe away any water in the cooking compartment.
4. Dry the cooking compartment.
  - To dry the cooking compartment, leave the appliance door open for 1 hour.

- To use the drying function, set "Drying function".  
→ "Setting the drying process", Page 30

#### **Setting the drying process**

**Requirement:** → "Drying the cooking compartment", Page 30

1. Press "Cleaning" in the menu.
2. Press  "Drying function".  
The duration cannot be changed.
3. Press .
- ✓ A notification stating that you should carry out the necessary preparatory work for the drying appears on the display.
4. Confirm the message.
  - ✓ The drying process starts and the duration counts down.
  - ✓ Once the drying has ended, a signal tone sounds. A message appears on the display confirming that the operation has finished.
5. Press  to switch the appliance off.
6. To dry the cooking compartment completely, leave the appliance door open for 1 to 2 minutes.

## 23 Appliance door

To clean the appliance door thoroughly, you can disassemble the appliance door.

### 23.1 Removing the door cover

The stainless steel inlay in the door cover may discolour. Remove the door cover in order to clean it and the stainless steel inlay, or to remove the door panes.

1. Open the appliance door slightly.
2. Press down on the left- and right-hand sides of the door cover ①.
3. Remove the door cover ② and carefully close the appliance door.

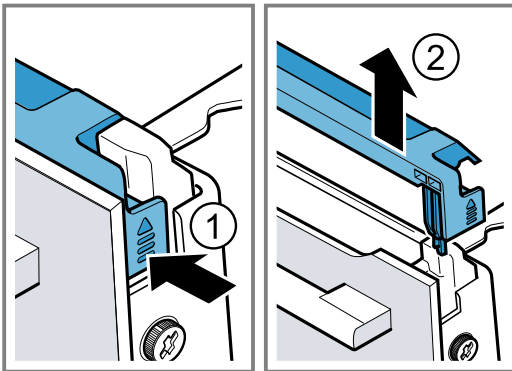

### 23.2 Removing the door panes

#### ⚠ WARNING – Risk of injury!

Scratched glass in the appliance door may develop into a crack.

- ▶ Do not use any harsh or abrasive cleaners or sharp metal scrapers to clean the glass on the oven door, as they may scratch the surface.

The hinges on the appliance door move when the door is opened and closed, which could trap your fingers.

- ▶ Keep your hands away from the hinges.

Components inside the appliance door may have sharp edges.

- ▶ Wear protective gloves.

**Requirement:** The door cover has been removed.

→ "Removing the door cover", Page 31

1. Undo and remove the screws ① on the left and right of the appliance door.
2. Place a folded-up tea towel in the appliance door.
3. Close the appliance door.
4. Pull the front pane up and out ②.

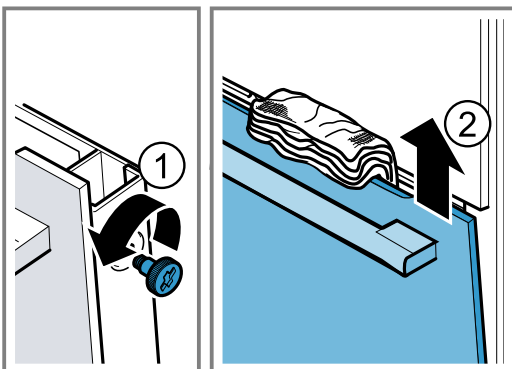

5. Place the front pane down on a flat surface with the door handle facing down.
6. Press the intermediate pane against the appliance with one hand while pushing the left- and right-hand retainers [a] upwards. Do not detach the retainers [a].

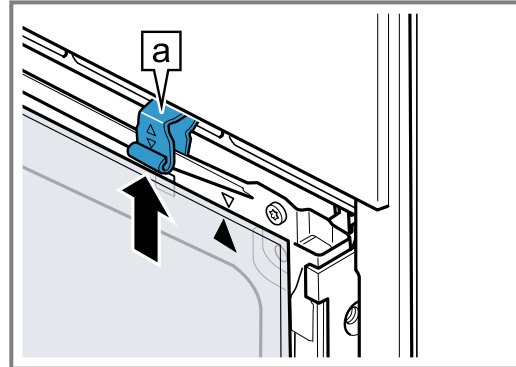

7. Remove the intermediate pane.
8. ⚠ **WARNING – Risk of serious harm to health!**  
If the screws are undone, the safety of the appliance can no longer be guaranteed. Microwave energy may escape.  
▶ Never undo the screws.

Never unscrew the four black screws on the frame.

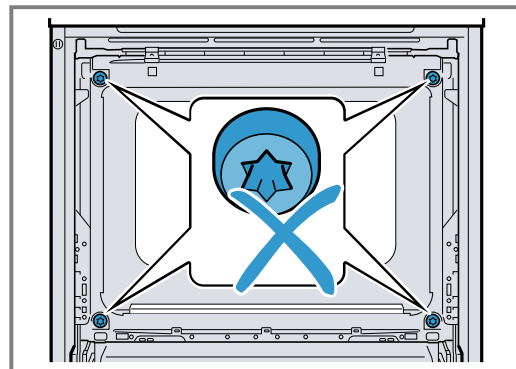

### 23.3 Fitting the door panes

#### ⚠ WARNING – Risk of injury!

The hinges on the appliance door move when the door is opened and closed, which could trap your fingers.

- ▶ Keep your hands away from the hinges.

Components inside the appliance door may have sharp edges.

- ▶ Wear protective gloves.

1. Turn the intermediate pane until the arrow **a** is in the top right.

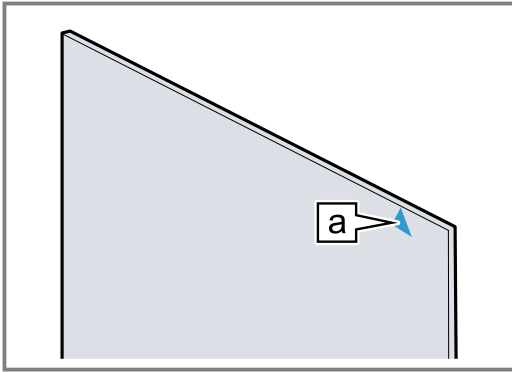

2. Insert the intermediate pane into the retainer **a** at the bottom ① and push it in firmly at the top.
3. Push the left- and right-hand retainer **a** downwards until the intermediate pane is clamped ②.

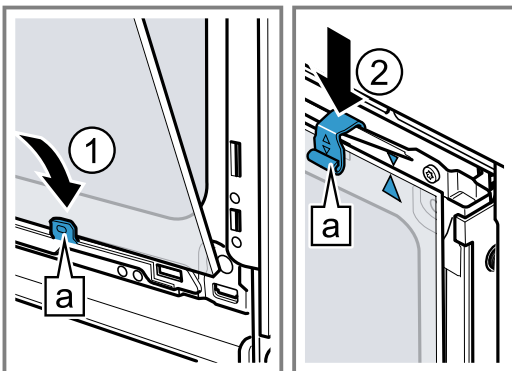

4. Attach the front pane downwards into the left- and right-hand retainers **a** ①.

5. Push the front pane to the appliance until the left- and right-hand hook **a** is opposite the support **b** ②.

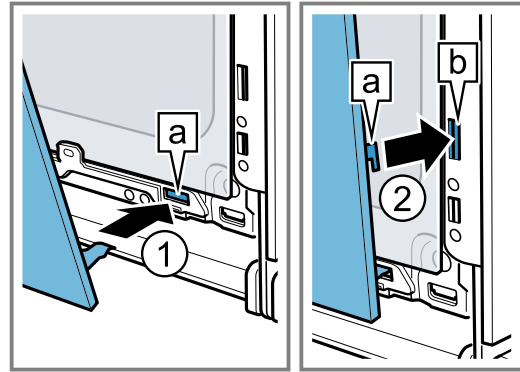

6. Push the front pane in at the bottom ① until you hear it click into place.
7. Open the appliance door slightly and remove the tea towel.
8. Screw both screws back in on the left and right of the appliance door.
9. Put the door cover in position and push down on it ② until you hear it click into place.

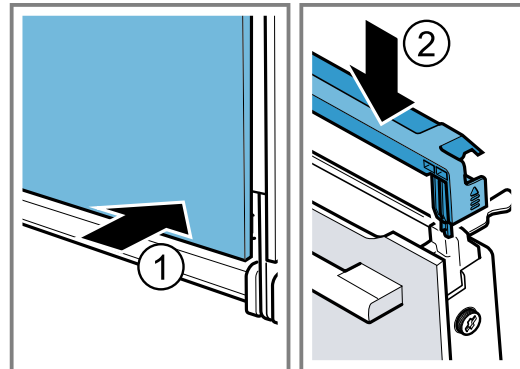

10. Close the appliance door.

**Note:** Do not use the cooking compartment again until the door panes have been correctly fitted.

## 24 Rails

To thoroughly clean the rails and the cooking compartment, or to replace the rails, you can remove the rails.

### 24.1 Detaching the rails

**⚠ WARNING – Risk of burns!**

The shelf supports get very hot

- ▶ Never touch the shelf supports when hot.
- ▶ Always allow the appliance to cool down.
- ▶ Keep children at a safe distance.

1. Lift the rail forwards ① and detach it ②.

2. Push the entire rail backwards ③ and take it out ④.

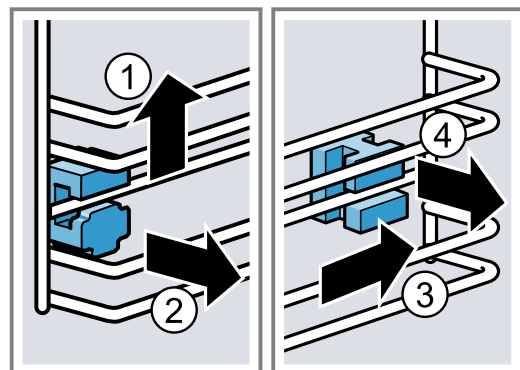

3. Clean the rail.  
→ "Cleaning products", Page 27

### 24.2 Fitting the retainers

The retainers may fall out when you detach the rails.

**Note:**  
The retainers at the front differ from those at the rear.

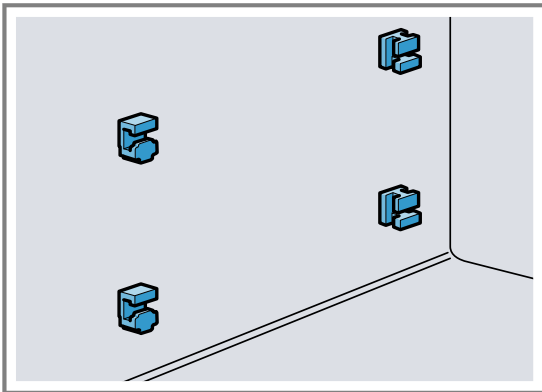

1. Hook the front retainers with the hook into the round hole at the top and set them at a slight angle ①.
2. Hook the front retainers in at the bottom and straighten them ②.

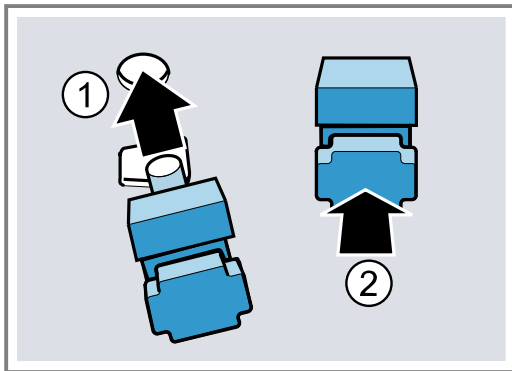

3. Hook the rear retainers with the hook into the top hole ① and push them into the bottom hole ②.

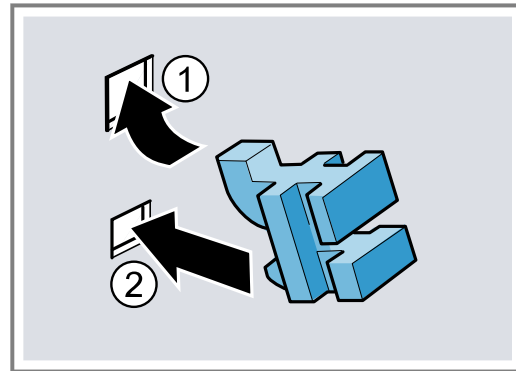

### 24.3 Attaching the rails

1. Hook the rear shelf support into the retainers at the top and bottom ① and pull it forwards ②.
2. Hook in the rail at the front ③ and press it down ④.

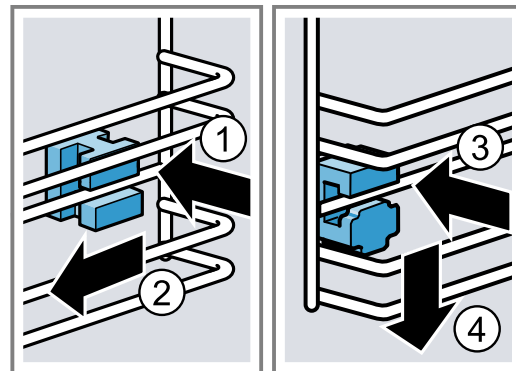

## 25 Troubleshooting

You can rectify minor faults on your appliance yourself. Read the troubleshooting information before contacting after-sales service. This will avoid unnecessary costs.

### **⚠ WARNING – Risk of injury!**

Improper repairs are dangerous.

- ▶ Repairs to the appliance should only be carried out by trained specialist staff.
- ▶ If the appliance is defective, call Customer Service.  
→ "Customer Service", Page 35





### **⚠ WARNING – Risk of electric shock!**

Improper repairs are dangerous.

- ▶ Repairs to the appliance should only be carried out by trained specialist staff.
- ▶ Only use genuine spare parts when repairing the appliance.
- ▶ If the power cord of this appliance is damaged, it must be replaced by the manufacturer, the manufacturer's Customer Service or a similarly qualified person in order to prevent any risk.

### 25.1 Malfunctions

Fault	Cause and troubleshooting
The appliance is not working.	The circuit breaker in the fuse box has tripped. ▶ Check the circuit breaker in the fuse box.
	There has been a power cut. ▶ Check whether the lighting in your room or other appliances are working.
Electronics fault	1. Disconnect the appliance from the power supply for at least 30 seconds by switching off the fuse.
	2. Reset the basic settings to the factory settings. → "Basic settings", Page 23

Fault	Cause and troubleshooting
"Sprache Deutsch" appears in the display.	<p>There has been a power cut.</p> <ul style="list-style-type: none"> <li>▶ Configure the initial configuration settings. → "Performing initial start-up", Page 13</li> </ul>
The operation does not start or is interrupted.	<p>Different causes are possible.</p> <ul style="list-style-type: none"> <li>▶ Check the notifications that appear on the display. → "Displaying information", Page 14</li> </ul>
Appliance does not heat up.	<p>Malfunction</p> <ul style="list-style-type: none"> <li>▶ Call → "Customer Service", Page 35.</li> </ul>
Appliance does not heat up.	<p>Demo mode is switched on.</p> <ol style="list-style-type: none"> <li>1. Briefly disconnect the appliance from the power supply by switching the circuit breaker in the fuse box off and then on again.</li> <li>2. Switch off demo mode in the basic settings within approx. 5 minutes. → "Changing the basic settings", Page 24</li> </ol>
The time is not displayed when the appliance is switched off.	<p>There has been a power cut.</p> <ul style="list-style-type: none"> <li>▶ Open and close the appliance door once after a power failure.</li> <li>✓ The appliance is checked and is ready to use.</li> </ul>
The time is not displayed when the appliance is switched off.	<p>Basic setting has been changed.</p> <ul style="list-style-type: none"> <li>▶ Change the basic setting for the time display. → "Basic settings", Page 23</li> </ul>
Appliance door cannot be opened.	<p>The cleaning function locks the appliance door;  lights up in the display.</p> <ul style="list-style-type: none"> <li>▶ Allow the appliance to cool down until  goes out in the display. → "Pyrolytic activeClean cleaning function", Page 28</li> </ul>
Appliance door cannot be opened.	<p>The childproof lock locks the appliance door.</p> <ul style="list-style-type: none"> <li>▶ Deactivate the childproof lock using the setting ring. → "Childproof lock", Page 23</li> </ul> <p>You can switch off the lock in the basic settings. → "Basic settings", Page 23</p>
Home Connect is not working properly.	<p>Different causes are possible.</p> <ul style="list-style-type: none"> <li>▶ Go to <a href="http://www.home-connect.com">www.home-connect.com</a>.</li> </ul>
During simple microwave operation, the cooking compartment becomes hot.	<p>The drying function is switched on.</p> <p>To prevent condensation from forming when the appliance is in microwave-only mode, the appliance automatically switches on an additional heating element when it is set to 600 W or 800 W. The cooking result is not affected by this.</p> <ul style="list-style-type: none"> <li>▶ You can change the basic setting for the drying function during microwave operation. → "Basic settings", Page 23</li> <li>- Observe the information on operating with microwave. → "Microwave", Page 16</li> </ul>
The interior lighting does not work.	<p>Basic setting has been changed.</p> <ul style="list-style-type: none"> <li>▶ Change the basic setting for the lighting. → "Basic settings", Page 23</li> </ul>
The interior lighting does not work.	<p>The LED light is defective.</p> <ul style="list-style-type: none"> <li>▶ Call → "Customer Service", Page 35.</li> </ul>
Maximum operating time reached.	<p>To prevent an unwanted permanent operation, the appliance automatically stops heating after several hours if the settings are unchanged. A message appears in the display. The point at which the maximum operating time is reached is determined by the corresponding settings for an operating mode.</p> <ol style="list-style-type: none"> <li>1. To continue operation, switch the appliance off and on again using . Reset and start the operation.</li> <li>2. If you do not need to use the appliance, press  to switch it off.</li> </ol> <p><b>Tip:</b> To prevent the appliance from switching off when you do not want it to, set a cooking time. → "Time-setting options", Page 15</p>

Fault	Cause and troubleshooting
Error code made up of letters and numbers appears on the display, e.g. E0111.	<p>The electronics have detected a fault.</p> <ol style="list-style-type: none"> <li>1. Switch the appliance off and on again.</li> <li>✓ If the fault was a one-off, the message disappears.</li> <li>2. If the message appears again, call the after-sales service. Please specify the exact error message when calling. → "Customer Service", Page 35</li> </ol>
The cooking result is not satisfactory.	<p>Settings were unsuitable. Adjustment values, e.g. temperature or cooking time, depend on the recipe, quantity and food.</p> <ul style="list-style-type: none"> <li>▶ Next time, set lower or higher values.</li> </ul> <p><b>Tip:</b> A lot of other information about the food preparation and corresponding adjustment values can be found in the Home Connect app or on our website <a href="http://www.bosch-home.com">www.bosch-home.com</a>.</p>

## 26 Disposal

### 26.1 Disposing of old appliance

Valuable raw materials can be reused by recycling.

1. Unplug the appliance from the mains.
2. Cut through the power cord.
3. Dispose of the appliance in an environmentally friendly manner.  
Information about current disposal methods are available from your specialist dealer or local authority.



This appliance is labelled in accordance with European Directive 2012/19/EU concerning used electrical and electronic appliances (waste electrical and electronic equipment - WEEE).

The guideline determines the framework for the return and recycling of used appliances as applicable throughout the EU.

## 27 Customer Service

Function-relevant genuine spare parts according to the corresponding Ecodesign Order can be obtained from Customer Service for a period of at least 10 years from the date on which your appliance was placed on the market within the European Economic Area.

**Note:** Under the terms of the manufacturer's warranty the use of Customer Service is free of charge.

Detailed information on the warranty period and terms of warranty in your country is available from our after-sales service, your retailer or on our website.

If you contact Customer Service, you will require the product number (E-Nr.), the production number (FD) and the consecutive numbering (Z-Nr.) of your appliance.

The contact details for Customer Service can be found in the enclosed Customer Service directory or on our website.

This product contains light sources from energy efficiency class G. These light sources are available as a spare part and should only be replaced by trained specialist staff.

### 27.1 Product number (E-Nr.), production number (FD) and consecutive numbering (Z-Nr.)

You can find the product number (E-Nr.), the production number (FD) and the consecutive numbering (Z-Nr.) on the appliance's rating plate.

You will see the rating plate with these numbers if you open the appliance door.

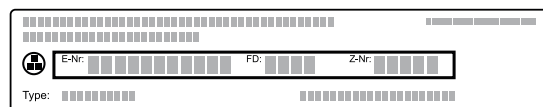

Make a note of your appliance's details and the Customer Service telephone number to find them again quickly.

You can also display the appliance information in the basic settings.

→ "Basic settings", Page 23

## 28 Information regarding Free and Open Source Software

This product includes software components that are licensed by the copyright holders as free or open source software.

The applicable licence information is stored on your home appliance. You can also access the applicable licence information via your Home Connect app: "Profile

-> Legal information -> Licence Information".<sup>1</sup> You can download the licence information on the brand product website. (Please search on the product website for your appliance model and additional documents). Alternatively, you can request the relevant information from [ossrequest@bshg.com](mailto:ossrequest@bshg.com) or BSH Hausgeräte GmbH, Carl-Wery-Str. 34, 81739 Munich, Germany. The source code will be made available to you on request.

Please send your request to [ossrequest@bshg.com](mailto:ossrequest@bshg.com) or BSH Hausgeräte GmbH, Carl-Wery-Str.34, 81739 Munich, Germany.

Subject: „OSSREQUEST“

The cost of performing your request will be charged to you. This offer is valid for three years from the date of purchase or at least as long as we offer support and spare parts for the relevant appliance.

## 29 Declaration of Conformity

BSH Hausgeräte GmbH hereby declares that the appliance with Home Connect functionality conforms to the essential requirements and other relevant provisions of Directive 2014/53/EU.

A detailed RED Declaration of Conformity can be found online at [www.bosch-home.com](http://www.bosch-home.com) among the additional documents on the product page for your appliance.



Hereby, BSH Hausgeräte GmbH declares that the appliance with Home Connect functionality is in compliance with relevant statutory requirements.<sup>2</sup>

A detailed Declaration of Conformity can be found online at [www.bosch-home.co.uk](http://www.bosch-home.co.uk) among the additional documents on the product page for your appliance.<sup>2</sup>



2.4 GHz band (2400–2483.5 MHz): Max. 100 mW  
5 GHz band (5150–5350 MHz + 5470–5725 MHz): max. 200 mW

	BE	BG	CZ	DK	DE	EE	IE	EL	ES
	FR	HR	IT	CY	LI	LV	LT	LU	HU
	MT	NL	AT	PL	PT	RO	SI	SK	FI
	SE	NO	CH	TR	IS	UK (NI)			

5 GHz WLAN (Wi-Fi): For indoor use only.

AL	BA	MD	ME	MK	RS	UK	UA
----	----	----	----	----	----	----	----

5 GHz WLAN (Wi-Fi): For indoor use only.

## 30 How it works

Here, you can find the ideal settings for various types of food as well as the best accessories and cookware. We have perfectly tailored these recommendations to your appliance.

**Tip:** A lot of other information about the food preparation and corresponding adjustment values can be found in the Home Connect app or on our website [www.bosch-home.com](http://www.bosch-home.com).

### 30.1 General cooking tips

Take note of the following information when cooking all types of food.

- The temperature and cooking time depend on the amount of food and the recipe. Settings ranges are specified for this reason. Try using the lower values to start with.

- The setting values apply to food placed in the cooking compartment while the cooking compartment is still cold. If you want to preheat anyway, do not place accessories into the cooking compartment until it has finished preheating.
- Remove any accessories that are not being used from the cooking compartment.

#### ATTENTION!

Acidic food may damage the grid

- ▶ Do not place acidic food, such as fruit or food with an acidic marinade directly on the pan support.

#### Information for those allergic to nickel

In rare cases, small amounts of nickel may pass into the food.

You can buy suitable accessories from customer service, from specialist retailers or online.

→ "Other accessories", Page 12

<sup>1</sup> Depending on the appliance specifications

<sup>2</sup> Only applies to Great Britain

**Tip**

For some food, you can use the ventilation function "Crisp Finish". For some food, you can use the ventilation function. The ventilation function "Crisp Finish" extracts moisture from the cooking compartment with increased intensity. This method is recommended for food with lots of moisture, e. g.

- for cooking on several levels
- for baked items with a moist toppings
- for meringue pastry
- when increased crispiness is required

For crispier food, we recommend switching this on in the second half of the cooking time.

→ "Ventilation function 'Crisp Finish'", Page 18

**30.2 Baking tips**

- Dark-coloured metal baking tins are most suitable for baking cakes, bread and other baked goods.
- Use wide, shallow cookware for bakes and gratins. Food takes longer to cook in deep, narrow cookware and it browns more on top.
- Silicone moulds are not suitable.
- If you are cooking bakes directly in the universal pan, place the universal pan into the cooking compartment at level 2.
- The setting values for bread dough apply to both dough placed on a baking tray and dough placed in a loaf tin.
- The recommended settings for baking in combination with the microwave mode are for metal baking tins.

**ATTENTION!**

When the cooking compartment is hot, any water inside it will create steam. The change in temperature may cause damage.

- ▶ Never pour water into the cooking compartment when it is still hot.
- ▶ Never place cookware containing water on the cooking compartment floor.

**Shelf positions**

If you are using the 4D hot air type of heating, you can choose between shelf positions 1, 2, 3 and 4. You will obtain the best results if you use the following shelf positions.

Baking on one level	Height
Tall baked items and tins/dishes on the wire rack	2
Shallow baked items/baking tray	3

Baking on two or more levels	Height
2 levels	
■ Universal pan	3
■ Baking tray	1
2 levels	
■ Baking tins/dishes on 2 wire racks	3
	1

Baking on two or more levels	Height
3 levels	
■ Baking tray	5
■ Universal pan	3
■ Baking tray	1
4 levels	
■ 4 wire racks with greaseproof paper	5
	3
	2
	1

Use the 4D hot air heating function.

**Notes**

- Items that are placed in the appliance on baking trays or in baking tins/dishes at the same time will not necessarily be ready at the same time.
- If you opt for cooking in combination with the microwave mode, you can only cook on one level.

**30.3 Roasting, braising and grilling tips**

- The recommended settings are for fridge-temperature food and unstuffed, oven-ready poultry.
- Place the poultry onto the cookware breast-side or skin-side down.
- Turn roasting joints, grilled items or whole fish after approx.  $\frac{1}{2}$  to  $\frac{2}{3}$  of the specified time.
- The meat probe allows you to cook with absolute precision. Take note of the important information on using it correctly. → Page 19

**Roasting on the wire rack**

Food roasted on the wire rack will become very crispy on all sides. You can roast large poultry, for example, or multiple individual pieces at the same time.

- Roast pieces of a similar weight and thickness. The grilled food will brown evenly and will remain succulent and juicy.
- Place the food to be roasted directly on the wire rack.
- To catch any liquids that drip down, place the universal pan into the cooking compartment one level below the wire rack.
- Add up to  $\frac{1}{2}$  litre of water to the universal pan, depending on the size and type of food that you want to roast.

You can make a sauce from the juices that are collected. This also means that less smoke is produced and the cooking compartment does not become as dirty.

**Roasting in cookware**

If you cover the cookware when you cook your food, this will keep the cooking compartment cleaner.

**General information about roasting in cookware**

- Use heat-resistant, ovenproof cookware.
- Place the cookware on the wire rack.
- Glass cookware is best.
- Follow the manufacturer's instructions for your roasting dishes.

**Roasting in uncovered cookware**

- Use a deep roasting dish.

- If you do not have any suitable cookware, you can use the universal pan.

### Roasting in covered cookware

- Use a suitable lid that seals well.
- When roasting meat, there should be at least 3 cm between the food and the lid. The meat may expand.

### WARNING – Risk of scalding!

Very hot steam may escape when the lid is opened after cooking. Steam may not be visible, depending on the temperature.

- ▶ Lift the lid in such a way that the hot steam can escape away from you.
- ▶ Keep children away from the appliance.

### Grilling

Grill food if you want it to be crispy.

The "Grill" type of heating is good for cooking thinner pieces of poultry, meat and fish such as steaks, drumsticks and burgers. It is also excellent for toasting bread.

Circulated air grilling is very well suited to cooking whole poultry and fish, as well as meat, e.g. roast pork with crackling.

- When grilling several food items, choose pieces that are of a similar weight and thickness. The grilled food will brown evenly and will remain succulent and juicy.
- Place the food to be grilled directly onto the wire rack.
- To catch any liquids that drip down, place the universal pan into the cooking compartment at least one level below the wire rack.

### Notes

- The grill element switches on and off continuously. This is normal. The grill setting that you use determines how frequently this occurs.
- Smoke may be produced when grilling.

## 30.4 Microwave cooking

If you cook food using the microwave mode, you can reduce the cooking time considerably.

### General information

- When using the microwave mode, the cooking time is determined based on the total weight. If you want to cook a quantity that differs from the specified quantity, the general rule is **Double the quantity requires just under double the cooking time.**
- The food transfers heat to the cookware. The cookware may become very hot.

- The main part of the instruction manual contains information on how to configure the microwave and microwave boost oven settings.  
→ "Microwave", Page 16

### Tip

You can find more microwave recipes here:

- → "Defrosting", Page 43
- → "Warming up food using the microwave mode", Page 44

### Cooking, braising or steaming using the microwave mode

- Use microwave-safe cookware with a lid. Alternatively, you can use a plate or special microwaveable film to cover the dish.
- For cereal products, e.g. rice, use deep cookware with a lid. Cereal products foam a lot during cooking. Add liquid in accordance with the instructions and information provided in the recommended settings tables.
- Do not wash or dry food. Add 1-3 tablespoons of water or lemon juice to the food.
- Spread the food out so that as much of it as possible is in contact with the bottom of the cookware. Food that is in contact with the bottom will cook more quickly than food that is piled up.
- Use salt and seasoning sparingly. When cooking food using the microwave mode, most of the food's natural flavour will be retained.
- Turn or stir the food 2-3 times during cooking.
- After cooking, leave the food to rest for 2-3 minutes.

## 30.5 Cooking instructions for ready meals

- The cooking result greatly depends on the quality of the food. Pre-browning and irregularities may already be present in the food before cooking.
- Do not use frozen products that are covered with a thick layer of ice. Remove any ice on the food.
- Take ready meals out of the packaging.
- If you are warming or cooking the ready meal in cookware, make sure that the cookware is heat-resistant.
- Distribute foods that are in the form of separate pieces, such as bread rolls and potato products, so that they are spread out flat and evenly on the accessory. Leave a little space between the individual pieces.
- Follow the manufacturer's instructions on the packaging.
- To achieve best results, we recommend that you re-heat food or ready meals at 600 watts. If the packaging specifies a higher microwave output setting, extend the time.

## 30.6 List of foods

Recommended settings for a variety of foods, sorted into food categories.





























### Recommended settings for various types of food

Food	Accessories/cook-ware	Shelf position	Heating function	Temperature in °C/grill setting	Microwave power setting in W	Cooking time in mins
Sponge cake, simple	Ring-shaped tin or Loaf tin	2		160-180	90	30-40
Sponge cake, delicate	Ring-shaped tin or Loaf tin	2		150-170	-	60-80
Sponge cake, 2 levels	Ring-shaped tin or Loaf tin	3+1		140-150	-	60-80
Fruit tart or cheesecake with shortcrust pastry base	Springform cake tin, diameter 26 cm	2		150-170	-	65-85
Fruit tart or cheesecake with shortcrust pastry base	Springform cake tin, diameter 26 cm	2		<b>1.</b> 160-180 <b>2.</b> 100	<b>1.</b> 180 <b>2.</b> -	<b>1.</b> 30-40 <b>2.</b> 20
Sponge flan, 6 eggs	Springform cake tin Ø 28 cm	2		150-160	-	50-60
Sponge flan, 6 eggs	Springform cake tin Ø 28 cm	2		150-170 <sup>1</sup>	-	30-50
Shortcrust tart with moist topping	Universal pan	3		160-180	-	55-75
Yeast cake with moist topping	Universal pan	3		180-190	-	30-40
Swiss roll	Baking tray	3		180-190 <sup>1</sup>	-	15-20
Muffins	Muffin tray	3		170-190	-	15-20
Small yeast cakes	Baking tray	3		160-180	-	25-40
Biscuits	Baking tray	3		140-160	-	15-30
Biscuits, 2 levels	Universal pan + Baking tray	3+1		140-160	-	15-30
Biscuits, 3 levels	x 2 Baking tray + Universal pan	5+3+1		140-160	-	15-30
Bread, 750 g	Universal pan or Loaf tin	2		<b>1.</b> 210-220 <b>2.</b> 180-190 <sup>1</sup>	-	<b>1.</b> 10-15 <b>2.</b> 25-35
Bread, 1500 g	Universal pan or Loaf tin	2		<b>1.</b> 210-220 <b>2.</b> 180-190	-	<b>1.</b> 10-15 <b>2.</b> 40-50
Bread, 1500 g	Universal pan or Loaf tin	2		200-210	-	35-45
Flatbread	Universal pan	3		250-270	-	20-25
Bread rolls, fresh	Baking tray	3		180-190	-	20-30
Pizza, fresh, on a baking tray	Baking tray	3		200-220	-	25-35









<sup>1</sup> Preheat the appliance.

<sup>2</sup> Turn the dish 2/3 of the way through the cooking time.

<sup>3</sup> Stir the food one or two times during cooking.

Food	Accessories/cook-ware	Shelf position	Heating function	Temperature in °C/grill setting	Microwave power setting in W	Cooking time in mins
Pizza, fresh, on a baking tray, 2 levels	Universal pan + Baking tray	3+1		180-190	-	35-45
Pizza, fresh, thin-crust, on a pizza tray	Pizza tray	2		220-230	-	20-30
Quiche	Dark coated quiche tin	3		190-210	-	30-40
Tarte flambée	Universal pan	3		260-280 <sup>1</sup>	-	10-15
Bake, savoury, cooked ingredients	Ovenproof dish	2		150-170	360	20-30
Lasagne, frozen, 350-450 g, 3 cm deep	Uncovered cook-ware	2		200-210	180	20-25
Lasagne, frozen, 600-1000 g, 4-5 cm deep	Uncovered cook-ware	2		200-210	180	35-45
Potato gratin, raw ingredients, 4 cm deep	Ovenproof dish	2		160-190	-	50-70
Potato gratin, raw ingredients, 4 cm deep	Ovenproof dish	2		170-190	360	20-25
Chicken, 1.3 kg, un-stuffed	Wire rack	2		200-220	-	60-70
Chicken, 1.3 kg, un-stuffed	Covered cookware	2		230-250	360	25-35
Small chicken portions, 250 g each	Wire rack	3		220-230	-	30-35
Small chicken portions, 250 g each	Uncovered cook-ware	2		190-210	360	20-30
Goose, unstuffed, 3 kg	Wire rack	2		160-180	-	120-150
Goose, unstuffed, 3 kg	Wire rack	2		170-190	180	80-90
Joint of pork without rind, e.g. neck, 1.5 kg	Uncovered cook-ware	2		180-190	-	110-130
Joint of pork without rind, e.g. neck, 1.5 kg	Covered cookware	2		220-240	360	55-65
Joint of pork without rind, e.g. neck, 1.5 kg	Uncovered cook-ware	2		190-200	-	120-140
Fillet of beef, medium, 1 kg	Wire rack	2		210-220	-	40-50
Pot-roasted beef, 1.5 kg	Covered cookware	2		200-220	-	130-160
Pot-roasted beef, 1.5 kg	Covered cookware	2		200-220	-	140-160
Sirloin, medium, 1.5 kg	Wire rack	2		220-230	-	60-70
Sirloin, medium, 1.5 kg	Uncovered cook-ware	2		240-260	180	30-40
Burger, 3–4 cm thick	Wire rack	4		3	-	25-30 <sup>2</sup>
Leg of lamb, boned, medium, 1.5 kg	Uncovered cook-ware	2		170-190	-	50-80
Leg of lamb, boned, medium, 1.5 kg	Covered cookware	2		240-260	<b>1.</b> 360 <b>2.</b> 180	<b>1.</b> 30 <b>2.</b> 35-40
Meat loaf, 1 kg + 20 ml water	Uncovered cook-ware	2		170-190	360	30-40
Fish, grilled, whole, 300 g, e.g. trout	Wire rack	2		170-180	-	20-30

<sup>1</sup> Preheat the appliance.<sup>2</sup> Turn the dish 2/3 of the way through the cooking time.<sup>3</sup> Stir the food one or two times during cooking.

Food	Accessories/cook-ware	Shelf position	Heating function	Temperature in °C/grill setting	Microwave power setting in W	Cooking time in mins
Fish, grilled, whole, 300 g, e.g. trout	Wire rack	3		2	90	15-20
Vegetables, fresh, 250 g	Covered cookware	2		-	600	6-10 <sup>3</sup>
Mixed vegetables, 250 g, + 25 ml water	Covered cookware	2		-	600	8-12 <sup>3</sup>
Baked potatoes, halved, 1 kg	Universal pan	3		200-220	360	15-20
Peeled boiled potatoes, quartered, 500 g	Covered cookware	2		-	600	12-15 <sup>3</sup>
Long-grain rice, 250 g + 500 ml water	Covered cookware	2		-	<b>1.</b> 600 <b>2.</b> 180	<b>1.</b> 7-9 <b>2.</b> 13-16
Millet, whole, 250 g, + 600 ml water	Covered cookware	2		-	<b>1.</b> 600 <b>2.</b> 180	<b>1.</b> 8-10 <b>2.</b> 5-10
Polenta or maize semolina, 125 g + 500 ml water	Covered cookware	2		-	600	6-8 <sup>3</sup>

<sup>1</sup> Preheat the appliance.

<sup>2</sup> Turn the dish 2/3 of the way through the cooking time.

<sup>3</sup> Stir the food one or two times during cooking.

## Desserts

### Making yoghurt

1. Remove the accessories and shelves from the cooking compartment.
2. Heat 1 litre of whole milk (3.5% fat) to 90 °C on the hob and then leave it to cool down to 40 °C. It is sufficient to heat UHT milk to 40 °C.
3. Mix 150 g of chilled yoghurt into the milk.
4. Pour the mixture into small containers, e.g. cups or small jars.
5. Cover the containers with film, e.g. cling film.
6. Place the containers on the cooking compartment floor.
7. Use the recommended settings when configuring the appliance settings.
8. After making the yoghurt, leave it to cool in the refrigerator for at least 12 hours.

### Making blancmange from blancmange powder

1. Use a deep, microwave-safe receptacle.
2. Pour the blancmange powder and all of the milk and sugar into the receptacle and mix.
3. Place the receptacle onto the wire rack and slide the rack into the cooking compartment.
4. Use the recommended settings when configuring the appliance settings.

5. As soon as the milk starts to rise, stir thoroughly.
6. Repeat the process until the required consistency is achieved.

### Using the microwave mode to make popcorn

#### **WARNING – Risk of burns!**

Airtight packaging may burst when food is heated.



- ▶ Always follow the instructions on the packaging.
  - ▶ Always use oven gloves to remove the dishes from the cooking compartment.
1. Use a microwave-safe, shallow ovenproof dish. Do not use porcelain or deep plates.
  2. Place the popcorn bag onto the cookware in accordance with the instructions on the packaging.
  3. Use the recommended settings when configuring the appliance settings.
  4. The time may need to be adjusted, depending on the product and quantity in question.
  5. Remove the popcorn bag after 1½ minutes and shake it to ensure that the popcorn does not burn.
  6. Place the popcorn bag back into the oven and leave it to continue popping.
  7. Once you can only hear popping noises once every 2-3 seconds, switch off the appliance and take the popcorn bag out of the oven.
  8. Wipe the cooking compartment clean afterwards.

### Recommended settings for desserts and compote

Food	Accessory/cook-ware	Shelf position	Type of heating → Page 10	Temperature in °C	Microwave power setting in W	Cooking time in mins
Blancmange made from blancmange powder	Covered cookware	2		-	600	5-8 <sup>1</sup>

<sup>1</sup> Stir the food one or two times during cooking.

<sup>2</sup> Place the sealed bag on the cookware.

Food	Accessory/cook-ware	Shelf position	Type of heating → Page 10	Temperature in °C	Microwave power setting in W	Cooking time in mins
Yoghurt	Individual moulds	Cooking compartment floor		40-45	-	8-9 hrs
Microwave popcorn, 1 x 100 g bag <sup>2</sup>	Uncovered cook-ware	2		-	600	4-6

<sup>1</sup> Stir the food one or two times during cooking.  
<sup>2</sup> Place the sealed bag on the cookware.

### 30.7 Special cooking methods and other applications

Information and recommended settings for special cooking methods and other applications, e.g. slow cooking.

#### Slow cooking

Cook prime cuts of meat slowly at a low temperature, e.g. tender cuts of beef, veal, lamb or poultry.

#### Slow cooking poultry or meat

**Note:** When using the slow cooking type of heating, you cannot delay the start of the programme by setting an end time.

**Requirement:** The cooking compartment is cold.

1. Use fresh, clean, hygienic meat without bones.
2. Place the cookware onto the wire rack at level 2 in the cooking compartment.
3. Preheat the cooking compartment and cookware for approx. 15 minutes.
4. Sear the meat on all sides on the hob at a very high heat.





5. Immediately place the meat into the pre-warmed cookware in the cooking compartment.  
To ensure that the temperature in the cooking compartment remains constant, keep the cooking compartment door closed during slow cooking.

#### Tips for slow cooking

Here you will find tips for achieving good results when slow cooking food.

Issue	Tip
You want to slow cook a duck breast.	<ul style="list-style-type: none"> <li>Place the cold duck breast into a pan.</li> <li>Sear the skin side first.</li> <li>Slow cook the duck breast.</li> <li>After slow cooking, grill the duck breast for 3 to 5 minutes until crispy.</li> </ul>
You want to serve your slow-cooked meat as hot as possible.	<ul style="list-style-type: none"> <li>Preheat the serving plate.</li> <li>Make sure that the sauces that accompany the duck breast are very hot when you serve them.</li> </ul>

#### Recommended settings for slow cooking

Food	Accessory/cookware	Height	Searing time in mins	Heating function	Temperature in °C	Microwave power setting in W	Cooking time in mins
Duck breast, medium rare, 300 g each	Uncovered cookware	2	6-8		90 <sup>1</sup>	-	45-60
Fillet of pork, whole	Uncovered cookware	2	4-6		80 <sup>1</sup>	-	45-70
Fillet of beef, 1 kg	Uncovered cookware	2	4-6		80 <sup>1</sup>	-	90-120
Veal medallions, 4 cm thick	Uncovered cookware	2	4		80 <sup>1</sup>	-	30-50
Saddle of lamb, boned, 200 g each	Uncovered cookware	2	4		80 <sup>1</sup>	-	30-45

<sup>1</sup> Preheat the appliance.

#### Air Fry

Cook food with Air Fry until crispy and with little fat. Air Fry is particularly suitable for meals that are normally fried in oil.

#### Cooking tips for Air Fry

Observe this information when cooking food with Air Fry.







- Only one level can be used when cooking with Air Fry.

- The Air Fry accessory makes food crispier. If the Air-Fry accessory is not included with the appliance as standard, you can obtain the Air-Fry accessory as an optional accessory.
- Do not preheat the oven.
- Do not use greaseproof paper. The air must circulate in the cooking compartment.
- Do not defrost frozen food.
- Cover the Air-Fry accessory or the universal pan evenly with the food. If possible, only distribute the food on the accessory in a single layer.

- Insert the accessory into the cooking compartment at level 3. If you use the Air Fry accessory, you can insert an empty universal pan at level 1 to protect against dirt.
- Turn the food halfway through cooking. If you are cooking larger quantities, turn the food twice.

**Tip:** Do not season the food until after you have cooked it. This makes the food crispier. Breaded vegetables are also suitable for cooking with Air Fry. To save fat, use a sprayer to spray the coating with oil. This forms a crispy crust with little fat.

### Recommended settings for Air Fry

Food	Accessory/cook-ware	Shelf position	Heating function	Temperature in °C	Microwave power setting in W	Cooking time in mins
Chips	Air Fry tray or Universal pan	3		180-200	-	15-20
Potato pockets, filled	Air Fry tray or Universal pan	3		180-200	-	15-20
Potato rösti	Air Fry tray or Universal pan	3		180-200	-	15-20
Chicken goujons, nuggets, frozen	Air Fry tray or Universal pan	3		180-200	-	8-12
Fish fingers	Air Fry tray or Universal pan	3		180-200	-	10-20
Broccoli, breaded	Air Fry tray or Universal pan	3		180-200	-	10-20

### Defrosting





You can defrost frozen food in your appliance.

#### Tips for defrosting food

- You can use the "microwave" mode to defrost frozen fruit, vegetables, poultry, meat, fish or baked goods.
- Remove frozen food from its packaging before you defrost it.
- Use heat-resistant, microwave-safe cookware.
- The recommended settings are for freezer-temperature food (-18 °C).

- Defrosting works best if you divide it into more than one step. The steps are listed one after the other in the recommended settings tables.
- Stir or turn the food 1-2 times during defrosting. Turn large items several times. Split the food into smaller pieces as it defrosts. Remove pieces that have already defrosted from the cooking compartment.
- Once the food has defrosted, switch off the appliance and leave the food in the appliance for another 10 to 30 minutes to allow the temperature to equalise.

### Recommended settings for defrosting food

Food	Accessory/cook-ware	Shelf position	Heating function	Temperature in °C	Microwave power setting in W	Cooking time in mins
Bread, 500 g	Uncovered cook-ware	2		-	<b>1.</b> 180 <b>2.</b> 90	<b>1.</b> 3 <b>2.</b> 10-15
Bread rolls	Wire rack	2		140-160	90	2-4
Cake, moist, 500 g	Uncovered cook-ware	2		-	<b>1.</b> 180 <b>2.</b> 90	<b>1.</b> 2 <b>2.</b> 10-15
Cake, dry, 750 g	Uncovered cook-ware	2		-	90	10-15

<sup>1</sup> Turn the dish halfway through the cooking time.

Food	Accessory/cook-ware	Shelf position	Heating function	Temperature in °C	Microwave power setting in W	Cooking time in mins
Chicken, whole, 1.3 kg	Uncovered cook-ware	2	☰	-	1. 180 2. 90	1. 10 2. 10-15 <sup>1</sup>
Meat, whole, e.g. joint, raw meat, 1 kg	Uncovered cook-ware	2	☰	-	1. 180 2. 90	1. 15 2. 20-30 <sup>1</sup>
Minced meat, mixed, 500 g	Uncovered cook-ware	2	☰	-	1. 180 2. 90	1. 5 2. 10-15 <sup>1</sup>
Fish, whole, 300 g	Uncovered cook-ware	2	☰	-	1. 180 2. 90	1. 3 2. 10-15 <sup>1</sup>
Berries, 300 g	Uncovered cook-ware	2	☰	-	180	5-10
Butter, defrosting, 125 g	Uncovered cook-ware	2	☰	-	90	7-9

<sup>1</sup> Turn the dish halfway through the cooking time.

### Warming up food using the microwave mode

You can use the microwave mode to warm up food or to defrost and warm up food in a single step.

#### Tips for warming up food using the microwave mode

- Use microwave-safe cookware with a lid.
- Turn or stir the food 2-3 times during warming.
- After warming up the food, leave it to rest for 1-2 minutes.
- The food transfers heat to the cookware. The cookware can become very hot.
- Make sure that you do the following when you are warming up baby food:
  - Place bottles on the wire rack without the teat or lid.
  - Shake or stir the baby food well after warming it up.
  - Always check the temperature of the baby food.
- Wipe the cooking compartment dry after using it to warm up food.

### ⚠ WARNING – Risk of scalding!

There is a possibility of delayed boiling when a liquid is heated. This means that the liquid reaches the boiling temperature without the usual steam bubbles rising to the surface. Exercise caution even when only gently shaking the container. The hot liquid may suddenly boil over and splatter.

- ▶ Always place a spoon in the container when heating liquids. This prevents delayed boiling.

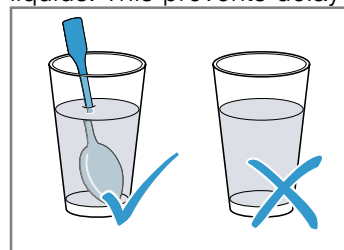

### ATTENTION!





Metal touching the wall of the cooking compartment will cause sparks, which may damage the appliance or the inner door pane.

- ▶ Metal (e.g. a spoon in a glass) must be kept at least 2 cm from the cooking compartment walls and the inside of the door.

### Recommended settings for heating and reheating

Food	Accessory/cook-ware	Shelf position	Heating function	Temperature in °C	Microwave power setting in W	Cooking time in mins
Drinks, warming up, 200 ml	Uncovered cook-ware	2	☰	-	Max.	1-3
Baby food, heating up, e.g. baby bottle, 150 ml	Uncovered cook-ware	2	☰	-	360	1-3
Vegetables, chilled, 250 g	Covered cookware	2	☰	-	600	3-8
Vegetables, frozen, loose, 250 g	Covered cookware	2	☰	-	600	8-12
Plated meal, chilled, 1 portion	Covered cookware	2	☰	-	600	4-8
Soup, stew, chilled, 400 ml	Covered cookware	2	☰	-	600	5-7 <sup>1</sup>

<sup>1</sup> Stir the food well.

Food	Accessory/cook-ware	Shelf position	Heating function	Temperature in °C	Microwave power setting in W	Cooking time in mins
Side dishes, e.g. pasta, dumplings, potatoes, rice, chilled	Covered cookware	2		-	600	5-10
Plated meal, frozen, 1 portion	Covered cookware	2		-	600	11-15
Soup, stew, frozen, 200 ml	Covered cookware	2		-	600	6-8 <sup>1</sup>
Side dishes, 500 g, e.g. pasta, dumplings, potatoes, rice, frozen	Covered cookware	2		-	600	7-12
Bakes, 400 g, e.g. lasagne, potato gratin, frozen	Uncovered cookware	2		180-200	180	20-25

<sup>1</sup> Stir the food well.

## Keeping food warm

### Tips for keeping food warm

- Using the "Keep warm" heating function prevents condensation from forming. You will not have to wipe down the cooking compartment.
- To prevent the food from drying out, you can cover it.
- Do not keep food warming for longer than 2 hours.
- Be aware that some types of food will actually continue cooking when you are keeping them warm in the oven.







## 30.8 Meals and tips for cooking for Great Britain

Recommended settings for meals with British cooking habits.

Also follow the instructions in the individual sections. This section contains only special additional information relating to British meals and cooking habits.







## Baking

### Recommended settings for baking on one level

Food	Accessory/cook-ware	Shelf position	Type of heating → Page 10	Temperature in °C	Microwave power setting in W	Cooking time in mins
Victoria sponge cake	x 2 20 cm diameter cake tin	2		160-170 <sup>1</sup>	-	20-25
Rich fruit cake	Deep, 23 cm diameter tin	2		130-150	-	150-180
Rich fruit cake	Deep, 23 cm diameter tin	2		130-140	90	80-90
Rich fruit cake	Deep, 23 cm diameter tin	2		140-160	-	120-180
Fruit pie	20 cm diameter plate or Pie tin	2		160-170	-	55-70
Fruit pie	20 cm diameter plate or Pie tin	2		170-190	-	60-75
Bread or white bread	Loaf tin, 1 x 900 g or 2 x 450 g	2		180-190 <sup>1</sup>	-	20-30

<sup>1</sup> Preheat the appliance.



<sup>2</sup> Preheat the appliance for five minutes. Do not use the rapid heating function.

Food	Accessory/cook-ware	Shelf position	Type of heating → <i>Page 10</i>	Temperature in °C	Microwave power setting in W	Cooking time in mins
Bread or white bread	Loaf tin, 1 x 900 g or 2 x 450 g	2		190-200	-	40-50
Scones	Baking sheet on wire rack	3		180-190 <sup>1</sup>	-	10-14
Biscuits	Baking sheet on wire rack	3		140-160 <sup>1</sup>	-	10-25
Small cakes	12-cup-tin	3		140-160 <sup>2</sup>	-	20-30
Pavlova	Baking sheet on wire rack	3		90-100 <sup>1</sup>	-	120-180
Yorkshire pudding	12-cup-tin	3		200-220 <sup>1</sup>	-	15-25

<sup>1</sup> Preheat the appliance.

<sup>2</sup> Preheat the appliance for five minutes. Do not use the rapid heating function.





### Recommended settings for baking on several levels

Food	Accessory/cook-ware	Shelf position	Type of heating → <i>Page 10</i>	Temperature in °C	Microwave power setting in W	Cooking time in mins
Victoria sponge cake, 2 levels	x 4 20 cm diameter cake tin	3+1		160-170 <sup>1</sup>	-	20-25
Biscuits, 2 levels	x 2 Baking sheet on wire rack	3+1		140-160 <sup>1</sup>	-	15-30
Biscuits, 3 levels	x 3 Baking sheet on wire rack	5+3+1		140-160 <sup>1</sup>	-	15-30

<sup>1</sup> Preheat the appliance.

## Grilling

### Recommended settings for meat

Food	Accessories/cook-ware	Shelf position	Type of heating → <i>Page 10</i>	Temperature in °C/grill setting	Microwave power setting in W	Cooking time in mins
Pork, Bacon rashers <sup>1</sup>	Wire rack	3		3 <sup>2</sup>	-	1. 4-5 2. 3-4 <sup>3</sup>
Pork, Sausages, thickness 2-4 cm	Wire rack	3		3 <sup>4</sup>	-	10-15 <sup>5</sup>
Pork, Belly	Wire rack	2		200-220	-	30+25
Pork, Gammon joint	Wire rack	2		180-200	-	30+25

<sup>1</sup> Slide the universal pan underneath the wire rack.



<sup>2</sup> Preheat the appliance for 5 minutes.

<sup>3</sup> Turn the food occasionally.

<sup>4</sup> Preheat the appliance for 3 minutes.

<sup>5</sup> Turn the food several times.

**Recommended settings for poultry**

Food	Accessory/cook-ware	Shelf position	Type of heating → Page 10	Temperature in °C	Microwave power setting in W	Cooking time in mins
Chicken, whole <sup>1</sup>	Wire rack	2		200-220	-	20+15
Chicken, portion 250 g each	Uncovered cook-ware	2		190-210	360	20-30

<sup>1</sup> Slide the universal pan underneath the wire rack.

**Roasting and braising****Cooking tips for roasting and braising**

Follow this information when frying or braising poultry or meat.

Calculating the cooking time, e.g. 20+35:



- To calculate the cooking time, assume 20 minutes per 500 g of meat. Then add an extra 35 minutes to that figure.

- For 1.5 kg, the cooking time would therefore be 95 minutes.



Cooking time range, e.g. 10-15:

- Your food will be ready within the specified range of time (in minutes).

**Recommended settings for meat**

Food	Accessory/cook-ware	Shelf position	Type of heating → Page 10	Temperature in °C	Microwave power setting in W	Cooking time in mins
Beef, Top side, Top rump	Wire rack	2		160-170	-	30+25
Lamb, Leg, bone-in	Wire rack	2		160-170	-	25+25
Pork, Belly	Wire rack	2		170-180	-	30+25

**Recommended settings for poultry**

Food	Accessory/cook-ware	Shelf position	Type of heating → Page 10	Temperature in °C	Microwave power setting in W	Cooking time in mins
Chicken, whole <sup>1</sup>	Wire rack	2		170-180	-	25+15
Turkey, crown	Wire rack	2		150-160	-	20+15
Turkey, whole, 4-8 kg	Wire rack	2		150-160	-	12+12 <sup>2</sup>



<sup>1</sup> Slide the universal pan underneath the wire rack.

<sup>2</sup> Turn the food after approx. one hour.

**Recommended settings for meat dishes**

Food	Accessory/cook-ware	Shelf position	Type of heating → Page 10	Temperature in °C	Microwave power setting in W	Cooking time in mins
Meat loaf, 1 kg, + 20 ml water	Uncovered cook-ware	2		170-190	360	30-40

**Recommended settings for bakes**

Food	Accessory/cook-ware	Shelf position	Type of heating → Page 10	Temperature in °C	Microwave power setting in W	Cooking time in mins
Diced meat, e.g. beef, pork, lamb, 500 g meat	Covered cookware	2		140	-	100-120
Diced meat, e.g. beef, pork, lamb, 500 g meat	Covered cookware	2		140 <sup>1</sup>	-	100-120

<sup>1</sup> Preheat the appliance.

### Recommended settings for complete meals

Food	Accessory/cook-ware	Shelf position	Type of heating → Page 10	Temperature in °C	Microwave power setting in W	Cooking time in mins
Complete meal with Chicken <sup>1</sup>	x 2 Wire rack	4+2		180	-	Chicken: (25+15) + 20

<sup>1</sup> Slide the universal pan underneath the wire rack.









### 30.9 Test dishes

The information in this section is provided for test institutes to facilitate testing of the appliance in accordance with EN 60350-1 or IEC 60350-1 and EN 60705 or IEC 60705.

#### Baking



- The setting values apply to food that is placed into a cold cooking compartment.
- Take note of the information on preheating in the recommended settings tables. These setting values apply without rapid heat-up.
- For baking, use the lower of the temperatures indicated first.
- Items that are placed in the appliance on baking trays or in baking tins/dishes at the same time will not necessarily be ready at the same time.
- Shelf positions when baking on 2 levels:
  - Universal pan: Shelf position 3
  - Baking tray: Shelf position 1
  - Baking tins on the wire rack:
    - First wire rack: Shelf position 3
    - Second wire rack: Shelf position 1
- Shelf positions when baking on 3 levels:
  - Baking tray: Shelf position 5
  - Universal pan: Shelf position 3
  - Baking tray: Shelf position 1
- Hot water sponge cake
  - When baking on 2 levels, place the springform tins at diagonally opposite corners of the wire racks.
  - As an alternative to a pan support, you can also use the Air Fry baking tray offered by us.

#### Recommended settings for baking

Food	Accessory/cook-ware	Shelf position	Type of heating → Page 10	Temperature in °C	Microwave power setting in W	Cooking time in mins
Shortbread	Baking tray	3		140-150 <sup>1</sup>	-	25-40
Shortbread	Baking tray	3		140-150 <sup>1</sup>	-	25-40
Shortbread, 2 levels	Universal pan + Baking tray	3+1		140-150 <sup>1</sup>	-	30-40
Shortbread, 3 levels	x 2 Baking tray + Universal pan	5+3+1		130-140 <sup>1</sup>	-	35-55
Small cakes	Baking tray	3		160 <sup>1</sup>	-	20-30
Small cakes	Baking tray	3		150 <sup>1</sup>	-	25-35
Small cakes, 2 levels	Universal pan + Baking tray	3+1		150 <sup>1</sup>	-	25-35
Small cakes, 3 levels	x 2 Baking tray + Universal pan	5+3+1		140 <sup>1</sup>	-	35-45
Hot water sponge cake	Springform cake tin, diameter 26 cm	2		160-170 <sup>2</sup>	-	25-35

<sup>1</sup> Preheat the appliance for five minutes. Do not use the rapid heating function.

<sup>2</sup> Preheat the appliance. Do not use the rapid heating function.

Food	Accessory/cook-ware	Shelf position	Type of heating → Page 10	Temperature in °C	Microwave power setting in W	Cooking time in mins
Hot water sponge cake	Springform cake tin, diameter 26 cm	2		160-170 <sup>2</sup>	-	25-35
Hot water sponge cake, 2 levels	x 2 Springform cake tin, diameter 26 cm	3+1		150-170 <sup>2</sup>	-	30-50

<sup>1</sup> Preheat the appliance for five minutes. Do not use the rapid heating function.

<sup>2</sup> Preheat the appliance. Do not use the rapid heating function.

## Grilling

### Recommended settings for grilling

Food	Accessories/cook-ware	Shelf position	Type of heating → Page 10	Temperature in °C/grill setting	Microwave power setting in W	Cooking time in mins
Toasting bread	Wire rack	5		3 <sup>1</sup>	-	3-5

<sup>1</sup> Do not preheat the appliance.



## Microwave cooking

- To test the microwave mode on its own, switch off the drying function in the basic settings. → Page 23



### Recommended settings for defrosting food using the microwave

Food	Accessory/cook-ware	Shelf position	Type of heating → Page 10	Temperature in °C	Microwave power setting in W	Cooking time in mins
Meat	Uncovered cook-ware	2		-	1. 180 2. 90	1. 5 2. 10-15

### Recommended settings for cooking food using the microwave

Food	Accessory/cook-ware	Shelf position	Type of heating → Page 10	Temperature in °C	Microwave power setting in W	Cooking time in mins
Custard	Uncovered cook-ware	2		-	1. 360 2. 180	1. 20 2. 20-25
Sponge	Uncovered cook-ware	2		-	600	7-9
Meat loaf	Uncovered cook-ware	2		-	600	22-27

### Recommended settings for cooking in combination with the microwave

Food	Accessory/cook-ware	Shelf position	Type of heating → Page 10	Temperature in °C	Microwave power setting in W	Cooking time in mins
Potato gratin	Uncovered cook-ware	2		170-190	360	25-30
Cakes	Uncovered cook-ware	2		180-200	180	18-23
Chicken	Wire rack	2		200-220	360	25-35 <sup>1</sup>

<sup>1</sup> Turn the dish 2/3 of the way through the cooking time.

## 31 Installation instructions



### 31.1 General installation instructions

Follow these instructions before you start installing the appliance.

- The installation cabinet must not have a back panel behind the appliance. There should be a gap of at least 35 mm between the wall and the cabinet base as well as the rear panel of the cabinet situated above.
- Ventilation slots and intake openings must not be covered.
- The safe operation of this appliance can only be guaranteed if it has been installed to a professional standard in accordance with these installation instructions. The installer shall be liable for damages incurred as a result of incorrect installation.
- Do not use the door handle for the transport or installation.
- Check the appliance for damage after unpacking it. Do not connect the appliance if it has been damaged in transit.
- Before starting up the appliance, remove any packaging material and adhesive film from the cooking compartment and the door.
- Proceed in accordance with the installation sheets for installing accessories.
- Fitted units must be heat-resistant up to 95 °C, and adjacent unit fronts up to 70 °C.
- Do not install the appliance behind a decorative door or the door of a kitchen unit. There is a risk of overheating.
- Cut-out work on the units should be carried out before installing the appliance. Remove any shavings. Otherwise, the correct operation of electrical components may be adversely affected.

- The mains socket for the appliance must either be located in the hatched area  or outside of the area where the appliance is installed.

Any unsecured units must be secured to the wall using a standard bracket .

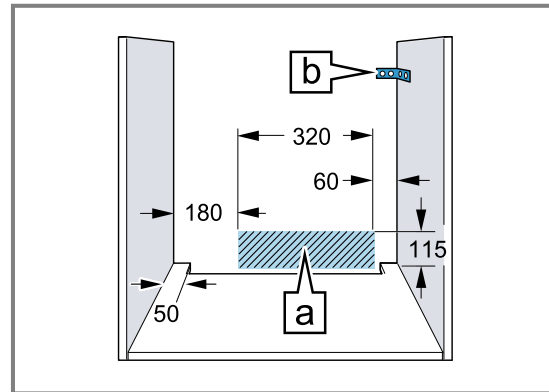

- Wear protective gloves so that you do not cut yourself. Parts that are accessible during installation may have sharp edges.
- Dimensions of the figures in mm.

### **WARNING – Risk of fire!**

It is dangerous to use an extended power cord and non-approved adapters.

- ▶ Do not use multiple socket strips.
- ▶ Only use extension cables that are certified, have a minimum cross section of 1.5 mm<sup>2</sup> and comply with the applicable national safety requirements.
- ▶ If the power cord is too short and a longer one is not available, please contact an electrician to have the domestic installation adapted.
- ▶ Only use adapters and power cords approved by the manufacturer.

### **ATTENTION!**

Carrying the appliance by the door handle could break it. The door handle cannot support the weight of the appliance.

- ▶ Do not carry or hold the appliance by the door handle.

### 31.2 Appliance dimensions

You will find the dimensions of the appliance here

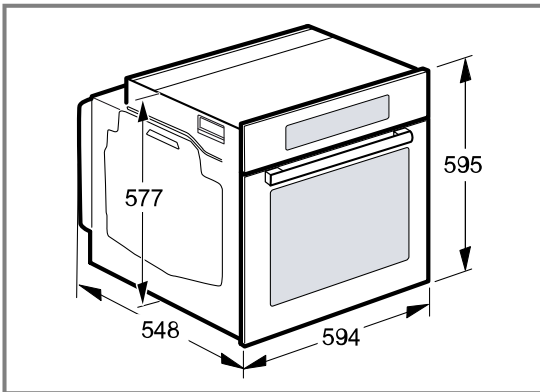

### 31.3 Installation below a worktop

Observe the installation dimensions and the installation instructions when installing below a worktop.

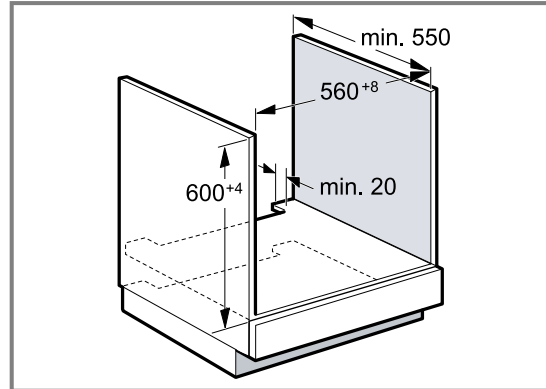

- To ventilate the appliance, the intermediate floor must have a ventilation cut-out.
- The worktop must be secured to the fitted unit.
- Observe any available installation instructions for the hob.
- Observe different national installation instructions for the hob.

### 31.4 Installation underneath a hob

If the appliance is installed under a hob, the following minimum dimensions must be adhered to (including substructure, if applicable).

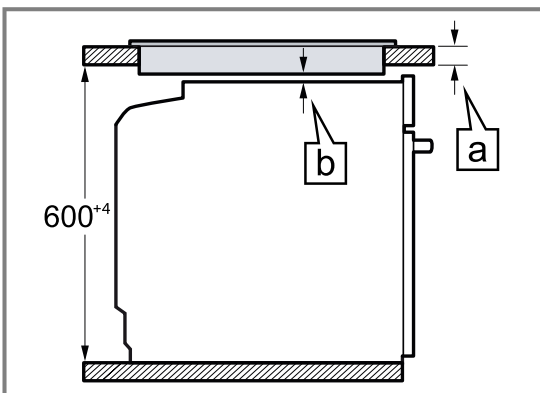

The minimum worktop thickness  $\boxed{a}$  is based on the required minimum clearance  $\boxed{a}$ .

Hob type	a raised in mm	a flush in mm	b in mm
Induction hob	37	38	5
Full-surface induction hob	47	48	5
Gas hob	27	38	5 <sup>1</sup>
Electric hob	27	30	2

<sup>1</sup> Observe different national installation instructions for the hob.

### 31.5 Installation in a tall unit

Observe the installation dimensions and the installation instructions when installing in a tall unit.

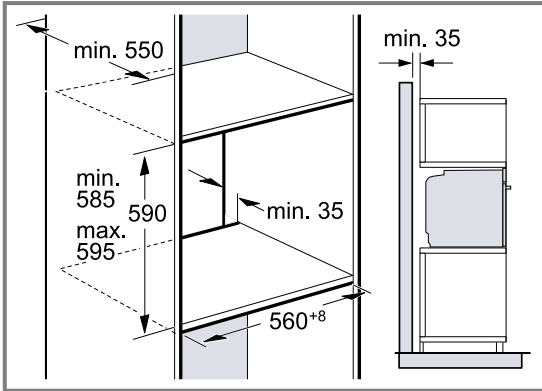

- To ventilate the appliance, the intermediate floors must have a ventilation cut-out.
- In order to ensure sufficient ventilation of the appliance, there must be a ventilation opening of at least 200 cm<sup>2</sup> in the base area. To do this, trim the base panel or fit a ventilation grille. Ensure that the air exchange is guaranteed in accordance with the diagram.

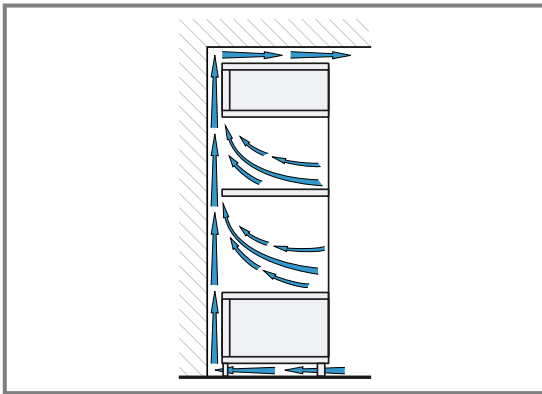

- If the tall unit has another back panel in addition to the element back panels, this must be removed.
- Only fit the appliance up to a height which allows accessories to be easily removed.

### 31.6 Corner installation

Observe the installation dimensions and the installation instructions when installing in a corner.

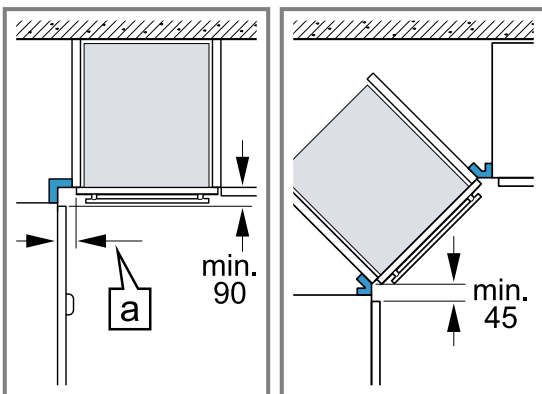

- To ensure that the appliance door can be opened, you must take the minimum dimensions into consideration when installing in a corner. The dimension a is dependent on the thickness of the unit front and the handle.

### 31.7 Electrical connection

In order to safely connect the appliance to the electrical system, follow these instructions.

- The appliance corresponds to protection class I and must only be operated with a protective earth connection.
- The fuse protection must correspond to the power rating specified on the appliance's rating plate and to the local regulations.
- The appliance must be disconnected from the power supply whenever installation work is being carried out.
- The appliance must only be connected using the power cable provided.
- The power cable must be plugged in at the rear of the appliance until you hear a clicking sound. A 3 m power cable can be obtained from the after-sales service.
- The power cable must only be replaced with a cable from the original manufacturer. This is available from after-sales service.
- Contact protection must be guaranteed by the installation.
- If the display on the appliance remains dark, it has not been connected correctly. Disconnect the appliance from the mains and check the connection.

#### Electrically connect the appliance with the protective contact plug

**Note:** The appliance must only be connected to a protective contact socket that has been correctly installed.

- ▶ Insert the plug into the protective contact socket. When the appliance is installed, the mains plug of the power cord must be freely accessible. If free access is not possible, an isolating switch must be integrated into the permanent electrical installation according to the installation regulations.

#### Electrically connecting an appliance without a protective contact plug

**Note:** Only licensed specialists may connect the appliance. Damage caused by incorrect connection is not covered under the warranty.

An isolating switch must be integrated into the permanent electrical installation according to the installation regulations.

1. Identify the phase and neutral conductors in the socket.  
The appliance may be damaged if it is not connected correctly.
2. Connect the hob in accordance with the connection diagram.  
See the rating plate for the voltage.
3. Connect the wires of the mains power cable according to the colour coding:
  - Green/yellow = Protective conductor (⊕)
  - Blue = Neutral conductor
  - Brown = Phase (external conductor)

### 31.8 Installing the appliance

1. Slide the appliance in fully and centre it.

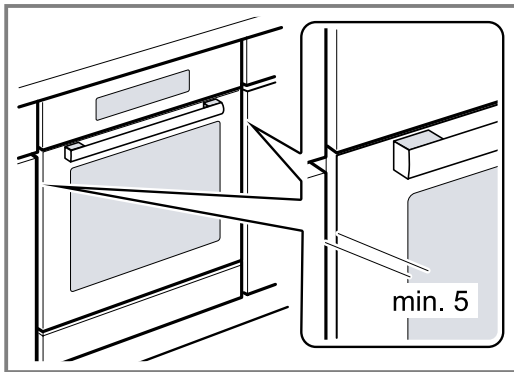

2. Screw the appliance into place.

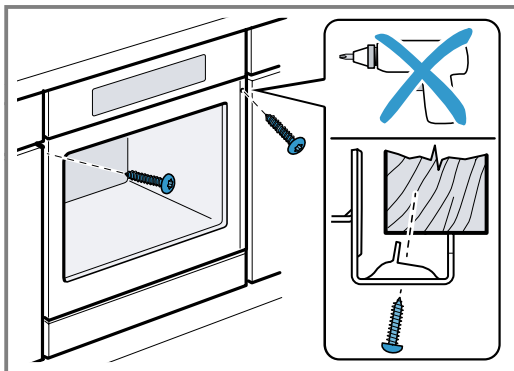

**Note:** The gap between the worktop and the appliance must not be closed by additional battens. Thermal insulation strips must not be fitted to the side panels of the surround unit.

### 31.9 For handleless kitchens with vertical bar handle strips:

1. Attach a suitable filling piece in order to cover any sharp edges and to guarantee a safe installation.

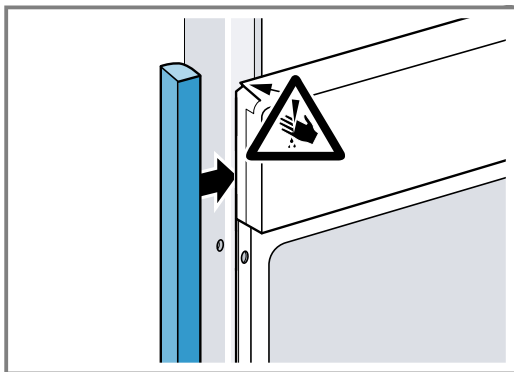

2. Pre-drill aluminium profiles to establish a screw connection.

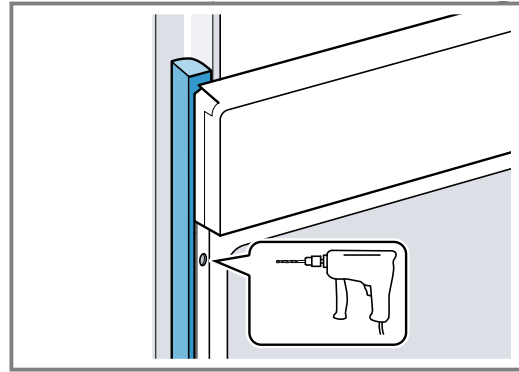

3. Secure the appliance using a suitable screw.

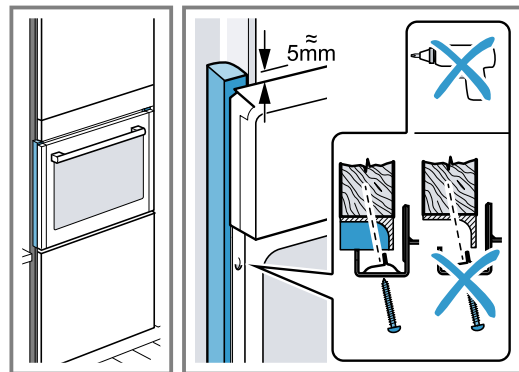

### 31.10 Removing the appliance

1. Disconnect the appliance from the power supply.
2. Undo the fastening screws.
3. Lift the appliance slightly and pull it out completely.







## Thank you for buying a Bosch Home Appliance!

Register your new device on MyBosch now and profit directly from:

- **Expert tips & tricks for your appliance**
- **Warranty extension options**
- **Discounts for accessories & spare-parts**
- **Digital manual and all appliance data at hand**
- **Easy access to Bosch Home Appliances Service**

Free and easy registration – also on mobile phones:

[www.bosch-home.com/welcome](http://www.bosch-home.com/welcome)

**BOSCH**  
HOME APPLIANCES  
**SERVICE**

## Looking for help? You'll find it here.

Expert advice for your Bosch home appliances, help with problems or a repair from Bosch experts.

Find out everything about the many ways Bosch can support you:

[www.bosch-home.com/service](http://www.bosch-home.com/service)

Contact data of all countries are listed in the attached service directory.

### **BSH Hausgeräte GmbH**

Carl-Wery-Straße 34  
81739 München, GERMANY  
[www.bosch-home.com](http://www.bosch-home.com)

A Bosch Company



**9001682779** (030727)

en

Valid within Great Britain:  
Imported to Great Britain by  
BSH Home Appliances Ltd.  
Grand Union House  
Old Wolverton Road  
Wolverton, Milton Keynes  
MK12 5PT  
United Kingdom