

HOBD472D2

Product Family	Hob
Built-in type	Ultra-low profile or Fully Flushed
Dimensions	70 cm
Power supply	Electric
Type	Induction with integrated hood
Extraction	Extraction
Electronic control	Yes
EAN code	8017709341862
Energy efficiency class (EEC)	A+

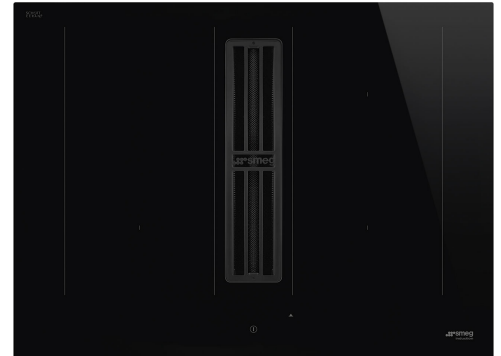

Aesthetics

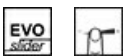

Aesthetic	Universale
Colour	Black
Finishing	Glass
Material	Glass
Glass type	Ceramic
Glass edge	Straight edge
Pan stands	Stainless steel
Type of control setting	EVO Slider
Slider	Yes
LED colours	Red
Control knob position	Front
Serigraphy colour	Grey

Programme / Functions

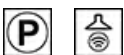

Total no. of cook zones	4
No. of induction cook zones	4
Time-setting options	Spegnimento automatico
No. of cooking zones with booster	4
No. of Flexible zones	2
Main on/off switch	Yes
Power levels	9
Auto-vent 2.0	Yes

Options



Multizone Option	Yes	Limited Power Consumption Mode	Si Advance
Flexible Zone Type	MultiZone	Limited Power Consumption Mode in W	2800, 3500, 4500, 7400 W
Worktop Cut-Out	490x560 mm	Showroom Demo Option	Yes
Keep warm automatic function	Yes	Control Lock / Child Safety	Yes
End cooking timer	4	Bridge option	Yes
Pause option	Yes	Cleaning option	Yes
Minute minder	1	Quick start	Yes
End of cooking alarm	Yes	Rapid level selection	Yes
Residual time indicator	Yes		

Technical Features



Front-left - 2.10 kW - Booster 3.00 kW - 21.0X19.0 cm			
Rear-left - 2.10 kW - Booster 3.00 kW - 21.0X19.0 cm			
Rear-right - 2.10 kW - Booster 3.00 kW - 21.0X19.0 cm			
Front-right - 2.10 kW - Booster 3.00 kW - 21.0X19.0 cm			
Multizone left - Booster 3.70 kW - 39.5x22.0 cm			
Multizone right - Booster 3.70 kW - 39.5x22.0 cm			
Automatic setting according to pan dimension	Yes	Automatic switch off when overflow	Yes
pan detection	Yes, min 9 cm	Residual heat indicator	Yes
Permanent Automatic Pot Detection with indication of the relative control	Yes	Protection against accidental start up	Yes

Accessories Included

Other accessories	Filtering kit and charcoal filter regenerable included
--------------------------	--

Electrical Connection

Plug	Not present	Type of electric cable installed	Universal
Electrical connection rating (W)	7620 W	Type of electric cable supplied	Universal
Current	33 A	Frequency (Hz)	50/60 Hz
Voltage (V)	220-240 V	Power supply cable length	120 cm
Voltage 2 (V)	380-415 V		

Terminal box 6 poles

Controls (hood)

Hood control setting	Touch Capacitive	Display	Yes
Led color	Rosso		

Programs / Functions (hood)

			
Delay function	Yes	Hood time setting	Delay
No. of speeds	8	Other options	Filter Kit included
Intensive speed	2	Auto-Vent	Yes

Technical Features (Hood)

Free outlet maximum capacity	650 m ³ /h	Anti-grease filters	Alluminio
Motor power	220 W	Charcoal filters included	YES, regenerable
No. of filters	1	Filter replacement indicator	Yes

Performance / Energy Label (hood)

Fluid Dynamic Efficiency (FDE)	32,10	Airborne acoustical A-weighted sound Power Emission at maximum speed (SPEmax)	68 dB(A)
Fluid Dynamic Efficiency class (FDEC)	A	Airbourne acoustical A-weighted sound power emission at boost speed (SPEboost)	73 dB(A)
Lighting Efficiency (LE)	0,0 lux/W	Power Consumption in Off mode (Po)	0,49 W
Lighting Efficiency Class (LEC)	NA	Time increase factor (F)	0,8
Grease Filtering Efficiency (GFE)	85,1 %	Energy Efficiency Index	44,2
Grease Filtering Efficiency Class (GFEC)	B	Measured air flow rate at best efficiency point (Qbep)	320 m ³ /h
Air flow at minumum speed (Qmin)	230 m ³ /h	Measured air pressure at best efficiency point (Pbep)	502 Pa
Air flow at maximum speed (Qmax)	500 m ³ /h	Measured electric power input at best efficiency point (Wbep)	139 W
Air flow at boost speed (Qboost)	630 m ³ /h	Sound power level at highest setting (Lwa)	68 dB(A)
Airbourne acouistical A-weighted sound Power Emission at minimum speed (SPEmin)	49 dB(A)		

Speed 1

Extraction rate IEC 61591	230 m ³ /h
Noise level IEC 60704-2-13	49 dB(A)
Pressure	280 Pa
Power	40 W

Speed 2

Extraction rate IEC 61591	270 m ³ /h
Noise level IEC 60704-2-13	51 dB(A)
Pressure	370 Pa
Power	50 W

Speed 3

Extraction rate IEC 61591	340 m ³ /h
Noise level IEC 60704-2-13	51 dB(A)
Pressure	400 Pa
Power	70 W

Speed 4

Extraction rate IEC 61591	370 m ³ /h
Noise level IEC 60704-2-13	60 dB(A)
Pressure	570 Pa
Power	90 W

Speed 5

Extraction rate IEC 61591	400 m ³ /h
Noise level IEC 60704-2-13	62 dB(A)
Pressure	500 Pa
Power	100 W

Speed 6

Extraction rate IEC 61591	435 m ³ /h
Noise level IEC 60704-2-13	63 dB(A)
Pressure	550 Pa
Power	120 W

Speed 7

Extraction rate IEC 61591	460 m ³ /h
Noise level IEC 60704-2-13	65 dB(A)
Pressure	600 Pa
Power	150 W

Speed 8

Extraction rate IEC 61591	500 m ³ /h
Noise level IEC 60704-2-13	68 dB(A)
Pressure	620 Pa
Power	170 W

Intensive speed

Extraction rate (IEC 61591)	540 m ³ /h
Noise level IEC 60704-2-13	70 dB(A)
Pressure	625 Pa
Power	180 W

Intensive Speed 2

Extraction rate IEC 61591	630 m ³ /h
Noise level IEC 60704-2-13	73 dB(A)
Pressure	630 Pa
Power	220 W

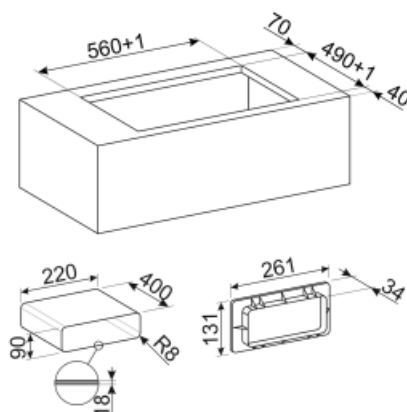
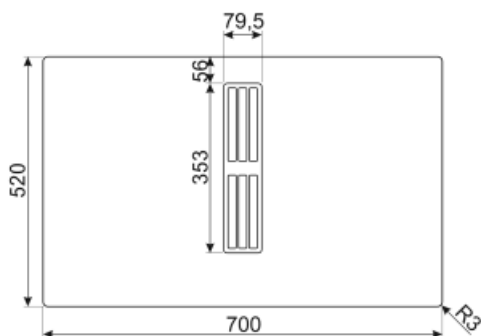
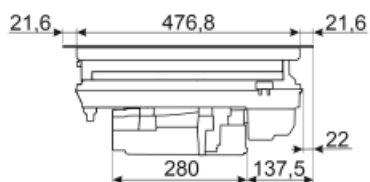
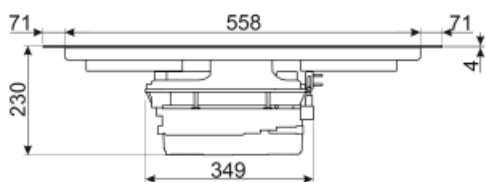

Not included accessories



KITEHOB10



CON90H



GRILLPLATE

Universal griddle for induction, gas, ceramic and electric hobs. Non-stick surface ideal for cooking meat, cheese and vegetables. Dimensions: 410 x 240 mm.

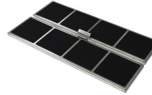

FLTHOBD2

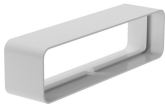

CON60H

Flat duct connector for tubes 220*60 mm. It help to connect more tubes of the kit KITEHOB4



RED60H

Reducer from 90 to 60 mm



GRIX6H



KITRHOB6

Mounting kit for recirculating installation: pipes and curves to be mounted in a plinth of minimum 6cm height. Available for HOBD*2 series.



GRI60H

Rectangular Louvred grille, external size 246*80 mm and internal 226*60*50 mm



TPK

Stainless steel grill plate to cook Teppanyaki dishes



TPKPLATE



















Universal plate for induction, gas, ceramic and electric hobs. Non-stick surface ideal for cooking fish, eggs and vegetables. Dimensions: 410 X 240 mm.

KITEHOB4

Filtering kit (lateral outlet) optional for Hobd: tube 1,5 mt and curve



Symbols glossary (TT)

	Permanent auto pot detection		Connection between hob and hood
	A smart infrared system, which allows a hood and hob with this feature to work together.		Power booster: option allows the zone to work at full power when very intense cooking is necessary.
	Child lock: some models are fitted with a device to lock the programme/cycle so it cannot be accidentally changed.		Evolution Slider totally Back-lighted ghost effect
	The slider control panel allows you to adjust the power simply by passing your finger across the touch device.		This function allows you to keep cooked food warm without burner it
	Multizone: allows several pans to be used at once, large or small, offering freedom of placement and greater flexibility		Overfill protection: The special overfill protection shuts down the stove in the presence of overflow of liquids.
	Min diameter pot detection of 9 cm		All cooking zones can be reduced to the minimum power level, so the hob can be left unattended for a short period without food overcooking or burning. Then just press again this function, the previously set power levels can be reactivated.
	Possibility to set the maximum power absorption of the hob		Quick selection, with one touch cooking begins at the highest level, then automatically reduces after time. Ideal for dishes that require quick boiling and then continued cooking without constant control (eg beef broth).
	Quick Start function: the chosen temperature is reached faster. The heating element works at maximum power until the right temperature is reached.		Indication of residual heat: After the glass ceramic hob is switched off the residual heat indicator shows which of the heating zones still remains hot. When the temperature drops below 60 ° C, the indicator goes out.
	Time elapsed: shows how long the cooking zone has been in use.		Timer: All ceramic hobs have a timer which automatically ends cooking after a preset time.
	TWIN_ZONE_72dpi		