



User Guide

Quality, Design and Innovation



home.liebherr.com/fridge-manuals

LIEBHERR

The appliance at a glance

Contents

1	The appliance at a glance.....	2
1.1	Delivered contents.....	2
1.2	Overview of the appliance and its equipment.....	3
1.3	Range of appliance use.....	3
1.4	Conformity.....	3
1.5	EPREL Database.....	3
2	General safety instructions.....	3
3	Start-up.....	4
3.1	Turning on the appliance.....	4
3.2	Insert the equipment.....	5
4	Food management.....	5
4.1	Storing food.....	5
4.2	Storage times.....	6
5	Energy saving.....	6
6	Use.....	6
6.1	Controls and displays.....	6
6.1.1	Status display.....	6
6.1.2	Navigation.....	6
6.1.3	Operating structure.....	6
6.1.4	Display symbols.....	7
6.2	Operating logic.....	7
6.2.1	Activating/deactivating settings.....	7
6.2.2	Selecting the function value.....	7
6.2.3	Activating/deactivating settings.....	7
6.2.4	Selecting the setting value.....	8
6.2.5	Calling up the customer menu.....	8
6.3	Functions.....	8
6.3.1	Setting the temperature.....	8
	SuperCool.....	8
	PowerCool.....	9
	PartyMode.....	9
	HolidayMode.....	9
	E-Saver.....	9
6.4	Settings.....	9
	Setting up the WLAN connection.....	9
	Entry lock.....	10
	Display brightness.....	10
	Door alarm.....	10
	Info.....	10
	SabbathMode.....	10
	CleaningMode.....	11
	Reminder.....	11
	Turn off appliance.....	11
6.5	Warnings.....	11
6.5.1	Message.....	11
6.5.2	DemoMode.....	11
7	Equipment.....	12
7.1	4-star freezer*.....	12
7.2	Door racks.....	12
7.3	Shelves.....	12
7.4	Split shelf*.....	13
7.5	VarioSafe*.....	13
7.6	Space for baking tray*.....	14
7.7	Drawers.....	14
7.8	EasyFresh-Safe.....	15
7.9	Humidity control.....	15
7.10	Pull-out board with bottle basket*.....	15
7.11	Accessories.....	16
8	Maintenance.....	16
8.1	FreshAir carbon filter*.....	16
8.2	Defrost the appliance.....	17
8.3	Cleaning the appliance.....	17
9	Customer support.....	18
9.1	Technical specifications.....	18
9.2	Operating noises.....	18
9.3	Technical faults.....	18
9.4	Customer service.....	19

9.5	Rating plate.....	20
10	Decommissioning.....	20
11	Disposing of the appliance.....	20

The manufacturer is constantly working to improve all models. Therefore please understand that we reserve the right to make design, equipment and technical modifications.

To get to know all the benefits of your new appliance, please read the information contained in these instructions carefully.

The instructions apply to several models, so there may be differences. Sections which only apply to certain appliances are indicated with an asterisk (*).

Instructions requiring the user to take action are marked with , the results of an action are marked with a .

These operating instructions apply to:

DRe / f	39.. / 41..
IRDe	51..
IRd / e / f	39.. / 40.. / 41.. / 45.. / 51..
IRSe / f	39.. / 41..

1 The appliance at a glance

1.1 Delivered contents

Check all parts for damage during transport. If you have any complaints, please contact the dealer or Customer Service (see 9.4 Customer service) .

Delivery contains the following parts:

- Integrated appliance
- Equipment (depending on your model)
- Installation parts (depending on your model)
- Quick Start Guide
- Installation Guide
- Service brochure

1.2 Overview of the appliance and its equipment

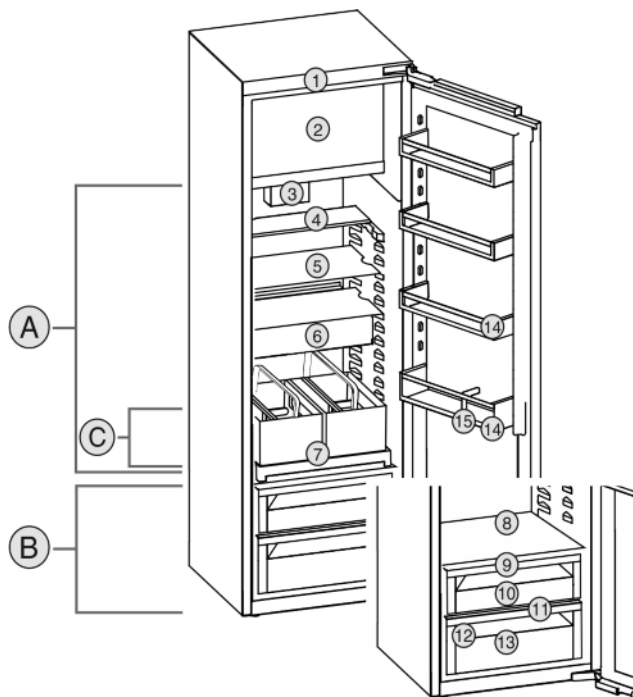

Fig. 1 Exemplary illustration

Temperature zone

(A) Fridge
(C) Coldest zone

(B) EasyFresh

Equipment

- | | |
|---|------------------------|
| (1) Controls | (9) EasyFresh-Safe |
| (2) 4-star freezer* | (10) EasyFresh drawer |
| (3) Fan with FreshAir active carbon filter* | (11) Drainage outlet |
| (4) Split shelf* | (12) Rating plate |
| (5) Shelf | (13) Vegetable drawer* |
| (6) VarioSafe* | (14) Door racks |
| (7) Pull-out board with bottle basket* | (15) Bottle rack |
| (8) Space for baking tray* | |

Note

► The shelves, drawers, and baskets are arranged for optimal energy efficiency in the factory configuration. However, changes to the arrangement within the given insertion options – for example the arrangement of shelves in the fridge compartment – have no effect on energy consumption.

1.3 Range of appliance use

Normal use

The appliance is only suitable for cooling food for residential or other similar environments. This includes the following types of uses

- in staff kitchens, bed and breakfasts,
- by guests in country homes, hotels, motels and other types of accommodations,
- for catering and similar wholesale services.

The appliance is not suitable for freezing food;*

All other types of uses are not permitted.

Foreseeable misuse

* Depending on model and options

The following uses are specifically prohibited:

- Storage and cooling of medication, blood plasma, laboratory preparations or similar substances and products in accordance with the Medical Device Directive 2007/47/EC
- Use in areas at risk of explosion

Incorrect appliance use can cause damage to the stored products or cause them to spoil.

Climate ratings

The appliance is set to operate within specific ambient temperature limits according to its climate rating. The climate rating for your appliance is printed on the rating plate.

Note

► To guarantee trouble-free operation, comply with the indicated ambient temperatures.

Climate rating	for ambient temperatures from
SN	10 °C to 32 °C
N	16 °C to 32 °C
ST	16 °C to 38 °C
T	16 °C to 43 °C

1.4 Conformity

The refrigerant circuit has been tested for leaks. When installed, the appliance complies with the relevant safety regulations as well as the Directives 2014/35/EU, 2014/30/EU, 2009/125/EC, 2011/65/EU and 2010/30/EU.

1.5 EPREL Database

Details about energy labeling and ecodesign requirements will be available on the European product database (EPREL) from March 1, 2021. You can access the product database at the following link: <https://eprel.ec.europa.eu/> You will be asked to enter the model ID. You can find the model ID on the nameplate.

2 General safety instructions

Dangers for the user:

- This appliance can be operated by children as well as by persons with reduced physical, sensory or mental capabilities or lack of experience and knowledge if they are supervised or have been instructed in the safe use of the appliance and understand the associated risks. Children must not play with the appliance. Cleaning and user maintenance must not be performed by children unless they are supervised. Children between the ages of 3 and 8 may load and unload the appliance. Children under the age of 3 must be kept away from the appliance if they are not constantly supervised.

Start-up

- When disconnecting the appliance from the outlet, always take hold of the plug. Do not pull on the cable.
- Disconnect the power plug or switch off the power if a fault occurs.
- Do not damage the mains power line. Do not operate the appliance from a defective mains power line.
- Repairs and operations on the appliance may only be carried out by the customer service department or other specifically trained specialist engineers.
- Only install, connect and dispose of the appliance in accordance with the instructions.
- Only operate the appliance after it has been installed.
- Please keep the instructions and pass them on to any future owner.

Risk of fire:

- The refrigerant contained within the appliance (specifications on the rating plate) is environmentally friendly, but flammable. Leaking refrigerant can ignite.
 - Do not damage the pipes of the refrigerant circuit.
 - Do not handle ignition sources inside the appliance.
 - Do not use electrical devices inside the appliance (e.g. steam cleaners, heaters, ice cream makers, etc.).
 - If refrigerant leaks: Remove naked flames or ignition sources located near the area of the leak. Air the room well. Contact the customer service department.
- Do not store explosive materials or spray cans with flammable propellants, such as e.g. butane, propane, pentane, etc. in the appliance. You can recognize such spray cans by the printed contents or a flame symbol. Any leaking gasses can be ignited by electrical components.
- Alcoholic beverages or other containers holding alcohol must always be tightly sealed for storage purposes. Any leaking alcohol can be ignited by electrical components

Tipover hazard:

- Do not stand or climb on the base, drawers, doors, etc. This applies in particular to children.

Risk of food poisoning:

- Do not consume food that has passed its best before date.

Danger of frostbite, feelings of numbness and pain:

- Avoid continued skin contact with cold surfaces or chilled/frozen food or adopt protective measures.

Risk of injury and damage:

- Hot steam may lead to injuries. Do not use any electrical heating or steam cleaning equipment, naked flames or defrosting sprays for defrosting
- Do not remove ice with sharp objects

Risk of crushing:

- Do not hold onto the hinge when opening and closing the door. Fingers may get caught.

Risk of damage to the slate front:

- Do not stick any stickers on the front.

Symbols on the device:



The symbol can be on the compressor. It refers to the oil in the compressor and refers to the following danger: Can be lethal if swallowed or inhaled. This notice only applies for recycling. There is no danger during normal operation.



The symbol is located on the compressor and indicates the danger of inflammable materials. Do not remove the label.



This label or a similar one can be located on the rear of the appliance. It refers to the foamed-in panels in the door and/or the housing. This notice only applies for recycling. Do not remove the label.

Follow the specific instructions in the other sections:

	DANGER	indicates a hazardous situation, which if not avoided, will result in death or serious injury.
	WARNING	indicates a hazardous situation, which if not avoided, could result in death or serious injury.
	CAUTION	indicates a hazardous situation, which if not avoided, will result in minor or moderate injury.
	NOTICE	indicates a hazardous situation, which if not avoided, could result in damage to property.
	Note	indicates useful advice and tips

3 Start-up

3.1 Turning on the appliance

Make sure that the following requirements are met:

- Appliance is installed and connected according to installation instructions.

- ❑ All adhesive strips, adhesive and protective films, as well as transport safety devices in and on the appliance are removed.
- ❑ All advertising material has been removed from the drawers.
- ▶ Switch on the appliance using the control panel next to the display.

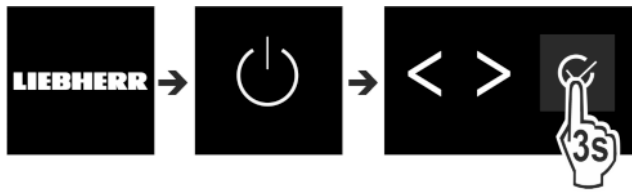

Fig. 2

- ▶ The status screen appears.
- ▶ If the DemoMode is displayed after switching on the appliance, the DemoMode can be deactivated within the next 5 minutes.

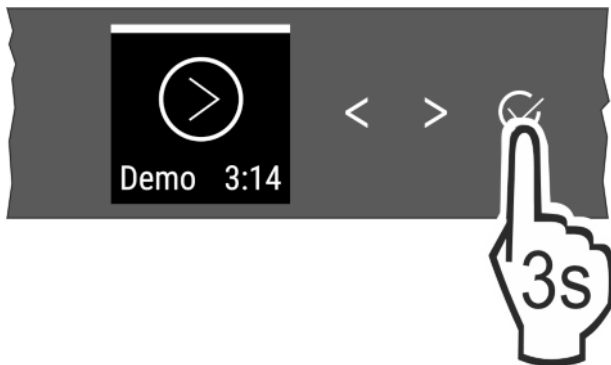

Fig. 3

- ▶ Press the confirmation button next to the display for 3 seconds.
- ▷ DemoMode is deactivated.

Note

The manufacturer recommends:

- ▶ Putting away groceries: Wait approx. 6 hours until the set temperature has been reached.
- ▶ Store **frozen produce** at -18 °C or lower.*

3.2 Insert the equipment

- ▶ Insert the supplied equipment to help you make the most of the appliance.
- ▶ Purchase the SmartDevice Box and insert it (see <https://smartdevice.liebherr.com/install>).
- ▶ Install the SmartDevice app (see <https://apps.home.liebherr.com/>).

Note

You can purchase accessories from the [Liebherr household appliance store](http://home.liebherr.com) (home.liebherr.com).

4 Food management

4.1 Storing food



WARNING

Danger of fire

- ▶ Do not use electrical appliances inside the food storage compartments of the appliance, unless they are of the type recommended by the manufacturer.

When storing food, remember these basic rules:

- ❑ Do not obstruct the air vents on the back wall.
- ❑ Do not obstruct the air vents on the fan.*
- ❑ Food is well sealed.
- ❑ Food that easily absorbs or emits odor or taste, are in sealed containers or are covered.
- ❑ Raw meat or fish is in clean, sealed containers so that other food cannot be touched or drip on them.
- ❑ Liquids are in sealed containers.
- ❑ Food is stored spaced apart to ensure good air circulation.

Note

Failure to follow these guidelines can lead to food perishing.

4.1.1 Fridge

The natural air circulation means the temperature varies in different sections.

Arranging the food:

- ▶ In the top section and in the door: butter and cheese, preserves, and tubes.
- ▶ The coldest zone Fig. 1 (C) is for: easily perishable food such as prepared meals, meat and sausages
- ▶ On the bottom shelf: raw meat and fish

4.1.2 EasyFresh-Safe

This compartment is for unsealed food, including fruit and vegetables.

The humidity depends on the moisture content of the stored items and how frequently the door is opened. You can regulate the moisture.

Arranging the food:

- ▶ Place unsealed fruit and vegetables.
- ▶ Excessive moisture: Regulate the air humidity (see 7.9 Humidity control).

4.1.3 Freezer compartment*

The air temperature in the compartment, which is measured with a thermometer or other measurement devices, can fluctuate. Temperature fluctuations are greater in a half-full or empty compartment, and temperatures can reach -18 °C and above.

Freezing food

You can freeze as many kilograms of fresh food within 24 hours as indicated on the nameplate under "Freeze capacity ... kg/24h".

To ensure that the food freezes quickly to the core, keep to the following quantities per pack:

- Fruit, vegetables up to 1 kg
- Meat up to 2.5 kg

Arranging the food:



CAUTION

There is a risk of injury from pieces of broken glass! Bottles and cans containing drinks can split or crack when frozen. This applies in particular to carbonated drinks.

- ▶ Do not freeze bottles and cans containing drinks
- ▶ Place sealed food in the freezer so that it is in contact with the floor or the side walls.

Defrosting food

- in the fridge compartment
- in the microwave
- in the oven/fan oven
- at room temperature

Energy saving



WARNING

Danger of food poisoning!

► Do not re-freeze defrosted food.

- Remove only the food you need for now.
- Use defrosted food as quickly as possible

4.2 Storage times

The storage times given are guidelines

Food with a "use by" date must still be consumed by the date indicated on the package

4.2.1 Fridge

The best-before date stated on the packaging applies.

4.2.2 Freezer compartment*

Guidelines for storage periods for various foods		
Ice cream	at -18 °C	2 to 6 months
Sausage, ham	at -18 °C	2 to 3 months
Bread, bakery products	at -18 °C	2 to 6 months
Game, pork	at -18 °C	6 to 9 months
Fish, fatty	at -18 °C	2 to 6 months
Fish, lean	at -18 °C	6 to 8 months
Cheese	at -18 °C	2 to 6 months
Poultry, beef	at -18 °C	6 to 12 months
Vegetables, fruit	at -18 °C	6 to 12 months

5 Energy saving

- Always ensure good ventilation. Do not obstruct ventilation openings or grilles.
- Never block air slits in the fan.*
- Do not install the appliance in direct sunlight or next to a stove, heater or similar heat source.
- Energy consumption depends on installation conditions such as the ambient temperature (see 1.3 Range of appliance use) . A warmer ambient temperature can increase the energy consumption.
- Avoid opening the appliance door for any longer then necessary
- The lower the temperature is set the higher the energy consumption.
- Sort your food items: home.liebherr.com/food.
- All food stored in the appliance should be well wrapped and covered. This prevents frost buildup.
- Only take food out for as long as necessary so that it does not get too warm.
- Insertion of warm foods: first let the food cool down to room temperature.
- Defrost frozen food in the fridge*
- If there is a thick layer of frost in the appliance Defrost the appliance.*
- For longer periods of absence, use HolidayMode (see HolidayMode) .

6 Use

6.1 Controls and displays

The display provides a quick overview of the temperature setting and the status of functions and settings. You can control the functions and settings either by deactivating/activating them or by selecting a value.

6.1.1 Status display

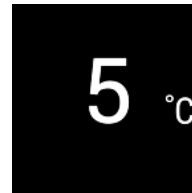

Fig. 4

(1) Fridge compartment temperature display

The Status display shows the set temperatures and is the home display. From there, you can navigate to the options and settings.

6.1.2 Navigation

Navigate in the menu to see the individual functions. An audible signal sounds after confirming a function or setting. If no selection is made after 10 s, the display switches to the Status screen.

The appliance is operated with the buttons:

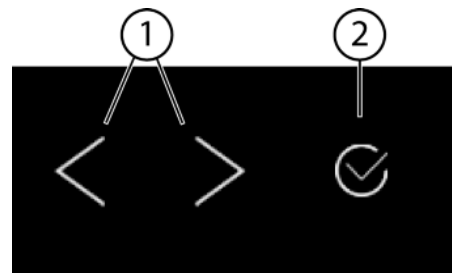

Fig. 5

(1) Left/right navigation arrow (2) Confirm

Left/right navigation arrow Fig. 5 (1):

- Navigate in the menu. After the final menu page, the first page is displayed again.
- Navigate in the submenu. After the final submenu page, the first page is displayed again.

Confirm Fig. 5 (2):

- Activating/deactivating functions.
- Open the submenu.
- Confirm the selection. The display returns to the menu.

Back:

- Confirm your selection in the submenu. The display returns to the menu.

- Select . The display returns to the function/setting.

Back to Status display:

- Close and open the door.
- Wait 10 s. The display switches to the Status display.

6.1.3 Operating structure

The controls are explained by a template. The display changes depending on the function or settings.

Menu without submenu

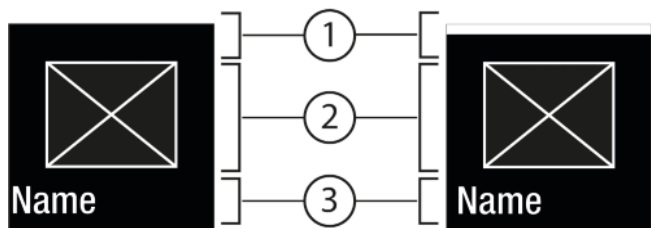

Fig. 6

- (1) Status
- (1) Off / On
- (2) Symbol or selected value
- (3) Menu: Function name or menu: Setting name

You can navigate as follows:

- Navigate with the left/right navigation arrow Fig. 5 (1).
- Press Confirm Fig. 5 (2) to activate Fig. 6 (1) / deactivate Fig. 6 (1) the function/setting.

Menu with submenu

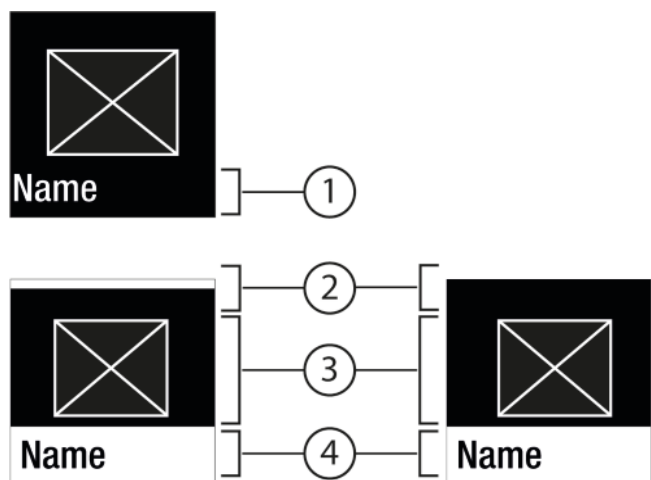

Fig. 7

- (1) Menu: Function name or menu: Setting name
- (2) Status
- (2) Off / On
- (3) Symbol or selected value
- (4) Submenu: Function name or submenu: Setting name

You can navigate as follows:

- Navigate with the left/right navigation arrow Fig. 5 (1).
- Press Confirm Fig. 5 (2) to go to the submenu Fig. 7 (4).
 - Navigate with the left/right navigation arrow Fig. 5 (1).
 - Set new level: Press Confirm Fig. 5 (2) to select a deselected value Fig. 6 (1).
 - Back to menu: Press Confirm Fig. 5 (2) to select the selected value Fig. 6 (2).

6.1.4 Display symbols

The display symbols provide information about the current appliance status.

Symbol	Appliance status
	Standby The appliance or temperature zone is turned off.
	Flashing number Appliance is working. Temperature flashes until the set temperature is reached.

Symbol	Appliance status
	Flashing symbol Appliance is working. Setting is made.

6.2 Operating logic

6.2.1 Activating/deactivating settings

You can activate/deactivate the following functions:

Symbol	Function
	SuperCool*
	PowerCool*
	HolidayMode
	E-Saver

* When a function is on, the appliance works harder. This means the appliance could make louder noises and consume more energy.

- ▶ Press the navigation arrows Fig. 5 (1) until appears.
- ▶ Press Confirm Fig. 5 (2).
- ▷ You hear the confirmation tone.
- ▷ Status appears in the menu.
- ▷ Function is on/off.

6.2.2 Selecting the function value

With the following functions you can set a value in the submenu:

Symbol	Function
	Setting the temperature Turn on/off the temperature zone

- ▶ Press the navigation arrows Fig. 5 (1) until the function appears.
- ▶ Press Confirm Fig. 5 (2).
- ▶ Use the navigation arrows Fig. 5 (1) to select the setting value.

Setting the temperature







- ▶ Press Fig. 5 (2) confirm.
- ▷ You hear the confirmation tone.
- ▷ Status: on Fig. 6 (1) appears briefly in the submenu Fig. 7 (4).
- ▷ Display switches back to the menu.

Switching the temperature zone on/off

- ▶ Press Confirm for 3 seconds.
- ▷ You hear the confirmation tone.
- ▷ Display returns to the status screen.

6.2.3 Activating/deactivating settings

You can activate/deactivate the following settings:

Symbol	Setting
	WiFi ¹
	Entry lock ²
	SabbathMode ²
	Cleaning Mode ²
	Reminders ¹
	Reset ²
	Switch off ²

- ▶ Press the navigation arrows *Fig. 5 (1)* until Settings  appears.
- ▶ Press Confirm *Fig. 5 (2)*.
- ▶ Press the navigation arrows *Fig. 5 (1)* until you can see the setting you want.

¹ Activate setting (short press)

- ▶ Press Confirm *Fig. 5 (2)*.
- ▷ You hear the confirmation tone.
- ▷ Status appears in the menu.
- ▷ Setting is activated / deactivated.

² Activate setting (long press)

- ▶ Press Confirm *Fig. 5 (2)* for 3 seconds.
- ▷ You hear the confirmation tone.
- ▷ Status appears in the menu.
- ▷ Display changes.

6.2.4 Selecting the setting value

With the following settings you can set a value in the submenu:



Symbol	Settings
	Door alarm

- ▶ Press the navigation arrows *Fig. 5 (1)* until Settings  appears.
- ▶ Press Confirm *Fig. 5 (2)*.
- ▶ Press the navigation arrows *Fig. 5 (1)* until you can see the setting you want.
- ▶ Press Confirm *Fig. 5 (2)*.
- ▶ Use the navigation arrows *Fig. 5 (1)* to select the setting value.
- ▶ Press Confirm *Fig. 5 (2)*.
- ▷ You hear the confirmation tone.
- ▷ Status appears briefly in the submenu.
- ▷ Display switches back to the menu.

6.2.5 Calling up the customer menu

The customer menu provides the following settings:

Symbol	Function
	C-Value ¹

- ▶ Press the navigation arrows *Fig. 5 (1)* so often until the settings  are displayed.
- ▶ Press Confirm *Fig. 5 (2)*.
- ▶ Press the navigation arrows *Fig. 5 (1)* so often until the appliance information  appears in the display.
- ▶ Press Confirm *Fig. 5 (2)*.
- ▶ Call up the customer menu: Enter the code 151.
- ▶ Press the navigation arrows *Fig. 5 (1)* in the customer menu so often until the desired setting is displayed.

¹ Select the setting value

- ▶ Press Confirm *Fig. 5 (2)*.
- ▷ You hear the confirmation tone.
- ▷ Status appears briefly in the display.
- ▷ The display switches back to the menu.

² Activate setting

- ▶ Press Confirm *Fig. 5 (2)* for 3 seconds.
- ▷ You hear the confirmation tone.
- ▷ Status appears in the display.
- ▷ The symbol flashes as long as the appliance is working.

6.3 Functions

6.3.1 Setting the temperature

The temperature depends on the following factors:

- the number of times the door is opened
- The duration the door is opened
- the room temperature of the installation location
- the type, temperature and amount of food

Temperature zone	Recommended setting
 5 °C Fridge	5 °C

Setting the temperature

- ▶ Set the level (see 6.2 Operating logic) .
- ▷ The set temperature is shown on the bottom right of the display.

Switching off the temperature zone

- ▶ Set the level (see 6.2 Operating logic) .
- ▷  appears.

SuperCool

Select this function for the maximum cooling setting, to reach lower cooling temperatures.

This function is relevant to the fridge section *Fig. 1 (A)*

You can also reach lower temperatures in the 4-star freezer.*

Use:

- Cool large amounts of food quickly.
- Freeze food.*

Activating/deactivating settings

- ▶ Using the 4-star freezer: activate the function when you add the goods.*
- ▶ Using the fridge section: activate the function when you add the goods.
- ▶ Activating/deactivating (see 6.2 Operating logic) .

The function automatically turns off. The appliance goes back to normal mode. The temperature adjusts itself to the set level.



PowerCool

This function provides the perfect blanket temperature to cool your food.

This function is relevant to the fridge section *Fig. 1 (A)*.

Use:

- For higher room temperatures (from approx. 35 °C)
- At high air moisture e.g. on summer days
- When storing moist goods, to avoid condensation building up inside

Activating/deactivating settings

- ▶ Activating/deactivating (see 6.2 Operating logic) .

Note

The fan can keep running even if the function has been deactivated. This ensures optimum temperature distribution in the appliance.

- ▷ Function activated: Energy consumption of the appliance is slightly increased.



PartyMode

This option offers an assortment of special functions and settings that are useful if you are having a party.

The following functions are activated:

- *SuperCool*

You can set any functions you like. Your changes are lost when the option is switched off.

Activating/deactivating settings

- ▶ Activating/deactivating (see 6.2 Operating logic) .
- ▷ On: All functions are activated at the same time.
- ▷ Off: Preset temperatures are restored.

The function is automatically switched off after 24 hours.



HolidayMode

This function minimizes the energy consumption during an extended absence. The temperature is increased to 15 °C.

Use:

- Save energy if you plan to be away for a while.
- Avoid coming home to bad smells and mold.

Activating/deactivating settings

- ▶ Empty everything from the fridge section.
- ▶ Activating/deactivating (see 6.2 Operating logic) .
- ▷ On: Fridge temperature is raised.
- ▷ Off: preset temperature is restored.



E-Saver

This function is designed to reduce energy consumption. Higher temperatures are preset for all temperature zones, which means the appliance has to cool less frequently.

Temperature of the fridge section: 7 °C

Temperature of the freezer section: -16 °C

Use:

- Save energy.

Activating/deactivating settings

- ▶ Activating/deactivating (see 6.2 Operating logic) .

- ▷ On: Higher temperatures are preset for all temperature areas.
- ▷ Off: Preset temperatures are restored.

6.4 Settings



Setting up the WLAN connection

This setting connects the appliance to the internet. The connection is managed in the SmartDevice Box. You can use the SmartDevice-App to add your appliance to a SmartHome-System. Use the SmartDevice-App or other compatible partner networks to enjoy advanced options and settings.

Note

The SmartDevice Box is available from the [Liebherr home appliance store \(home.liebherr.com\)](https://home.liebherr.com).

More information about availability, requirements, and the individual options can be found online at smartdevice.liebherr.com.

Use:

- Manage the appliance with the SmartDevice-App or a compatible partner network.
- Enjoy advanced functions and settings.
- Check the appliance status on the SmartDevice-App.

- Purchase the SmartDevice Box and insert it (see <https://smartdevice.liebherr.com/install>).
- Install the SmartDevice app (see <https://apps.home.liebherr.com/>).

Setting up the WLAN connection

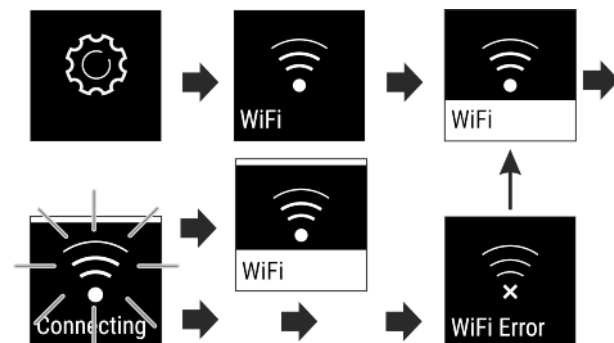

Fig. 8

- ▶ Activate (see 6.2 Operating logic) .
- ▷ The connection is set up: Status: on *Fig. 6 (1)* and WiFi connecting appears. The symbol flashes.
- ▷ The connection is set up: Status: on *Fig. 6 (1)* appears.
- ▷ The connection is set up: WiFi appears, the display turns blue.
- ▷ The connection failed: Status and Connect appears. The symbol appears permanently.

Disconnecting

- ▶ Deactivate the setting (see 6.2 Operating logic) .

Use

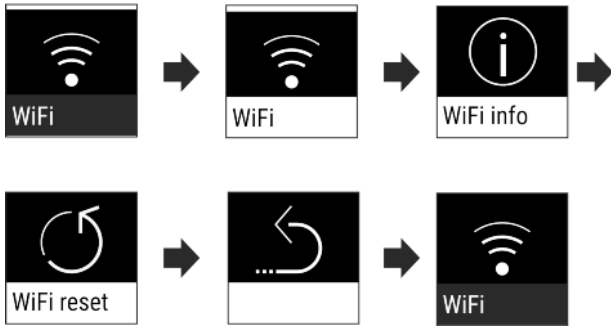



Fig. 9

There is no connection: The symbol  is displayed constantly.

Restoring the connection

► Restore settings (see 6.2 Operating logic) .

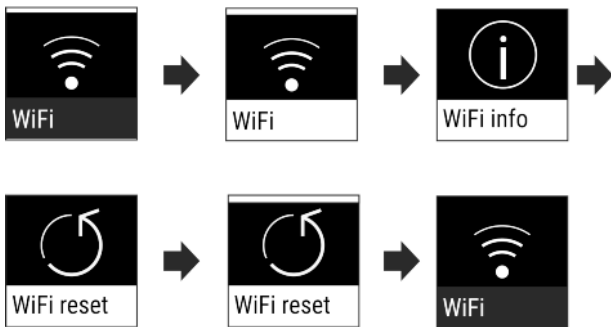

Fig. 10

► Connection and other settings are restored to factory settings.



Entry lock

This setting avoids accidental operation of the appliance, e.g. by children.

Use:

- Avoid unintentional changing of settings and functions.
- Avoid unintentional switching off of the appliance.
- Avoid unintentional temperature adjustments.

Activating/deactivating settings

► Activating/deactivating (see 6.2 Operating logic) .



Display brightness

With this setting, you can choose a brightness level for the display.

You can set the following brightness levels:

- 40%
- 60%
- 80%
- 100%

Choosing the setting

► Set the level (see 6.2 Operating logic) .



Door alarm

Set the time before the door alarm (see Close door) sounds.

Options are as follows:

- 1 min
- 2 min
- 3 min
- Off

Choosing the setting

► Set the level (see 6.5 Warnings) .



Info

This setting gives you appliance data and access to the customer menu.

It provides the following information:

- Model name
- Index
- Serial number
- Service number

View appliance data

- Press the navigation arrows *Fig. 5 (1)* until Settings  appears.
- Press Confirm *Fig. 5 (2)*.
- Press the navigation arrows *Fig. 5 (1)* until you can see the Info screen.
- Read the appliance data.



SabbathMode

This setting meets the religious requirements on the Sabbath and Jewish festivals. Turn on SabbathMode to switch off certain controls. This means you can use the appliance without anyone changing any settings.

You can find a list of Star-K-certified appliances at www.star-k.org/appliances.



WARNING

Danger of food poisoning!

If there is a power outage when SabbathMode is on, this message is not saved. When the power is restored, the appliance continues in SabbathMode. Afterwards, the temperature display does not show a message about the power outage.

If there was a power outage during SabbathMode:

- Check the quality of the food. Do not consume spoiled food!

What happens on the appliance when in SabbathMode:

- The Status display permanently shows SabbathMode.
- The display is locked for all functions apart from turning off SabbathMode.
- Any functions/settings that are already on, remain active.
- The display stays bright when the door is closed.
- Reminders are disabled. The set timer interval is also stopped. The function is no longer executed in SabbathMode.
- Reminders and warnings are not displayed. No acoustic signals are emitted and the display does not show warnings / settings such as temperature alarm or door alarm.
- The internal light is off.
- The defrost cycle only works for the specified time without taking account of fridge use.
- After a power cut the appliance automatically returns to SabbathMode.

Activating/deactivating SabbathMode

- ▶ To activate this function, click the arrows next to the display until you see the Settings  menu item and then confirm. The menu shows the available settings.
- ▶ Click the arrows next to the display until you see the SabbathMode (Menora) symbol. Confirm the symbol.
- ▷ A white bar appears in the top part of the display.
- ▷ SabbathMode has been activated.

To deactivate this function, press the confirmation button next to the display for 3 seconds.

SabbathMode has been deactivated.



CleaningMode

This setting makes it easy to clean the appliance.

This setting is relevant to the fridge section *Fig. 1 (A)*.

Use:

- Clean the fridge section manually.

What happens with the appliance when this setting is on:

- The refrigerator compartment is switched off.
- The internal light is on.
- Reminders and warnings are not shown. There is no acoustic signal.

Activating/deactivating settings

- ▶ Activate/deactivate setting (see 6.2 Operating logic) .
- ▷ On: Fridge compartment is switched off. Light stays on.
- ▷ Off: preset temperature is restored.

The setting is automatically deactivated after 60 minutes. Then the appliance continues operation in normal mode.



Reminder

Reminders are displayed acoustically by a beep and visually by a symbol in the display. The signal gets louder until the alert stops.



Replace the FreshAir active carbon filter*

This message appears when the air filter needs replacing.

- ▶ Replace the air filter every six months.
- ▶ Confirm the message with OK.
- ▷ The service interval resets.
- ▷ The air filter guarantees the air quality in the fridge.

Activate setting

- ▶ Activating/deactivating (see 6.2 Operating logic) .



Turn off appliance

This setting turns off the whole appliance.

Switch off whole appliance

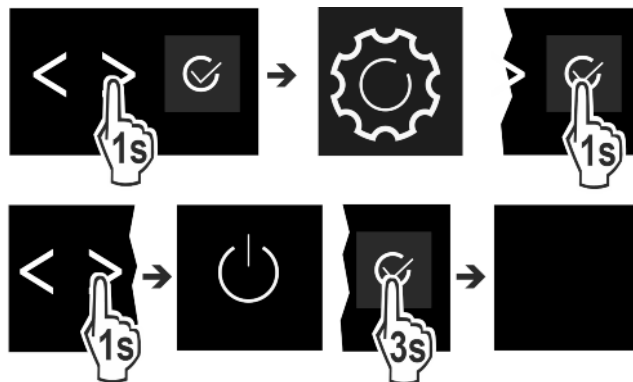

Fig. 11

- ▶ Activating/deactivating (see 6.2 Operating logic) .
- ▷ Off: Display turns black.

6.5 Warnings

Warnings are issued with an acoustic signal and visually with a symbol on the display. The signal gets louder until the alert stops.

6.5.1 Message



Close door

This message appears if the door is open too long.

You can set the time before this message appears .

- ▶ Stop alarm: Confirm the message.

-or-

- ▶ Close the door.



Error

This message appears when there is a fault with the appliance. An appliance component has an error.

- ▶ Open the door.
- ▶ Take note of the error code.
- ▶ Confirm the message.
- ▷ The acoustic warning ceases
- ▷ The display changes to the Status screen.
- ▶ Close the door.
- ▶ Contact Customer Service (see 9.4 Customer service) .

6.5.2 DemoMode

If D appears in the display, demo mode is on. This feature is designed for retailers. The cooling features are disabled.

Switching off DemoMode

When you see a time counting down:

- ▶ Confirm within the countdown.
- ▷ DemoMode is off.

If there is no countdown:

- ▶ Disconnect the power plug.
- ▶ Reconnect the power plug.
- ▷ DemoMode is off.

7 Equipment

7.1 4-star freezer*

7.1.1 Open/close freezer

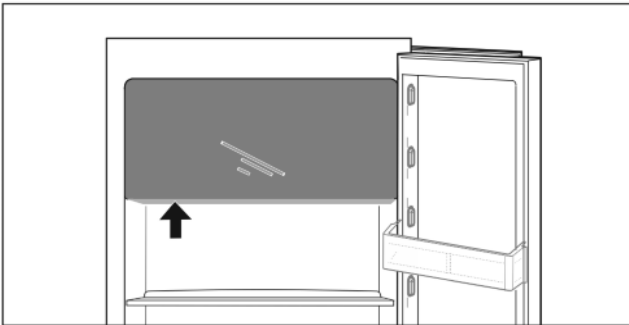
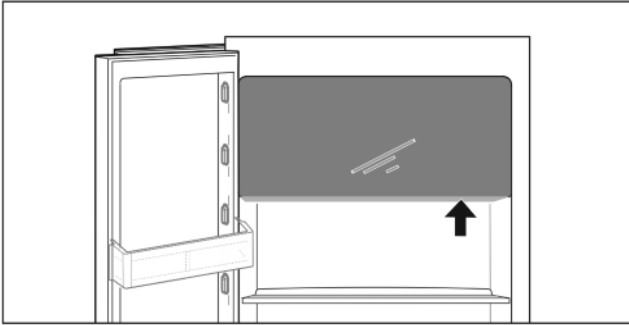

Fig. 12

Open freezer:

- ▶ Grab the handle.
- ▶ Push the handle plate and pull the door forward at the same time.

Close freezer:

- ▶ Close the door and press from the front at the same time.
- ▷ Door is engaged.

7.2 Door racks

7.2.1 Moving/removing door racks

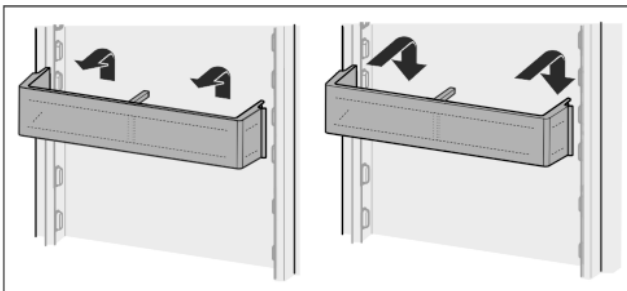

Fig. 13

- ▶ Remove racks as per the illustration

7.2.2 To dismantle door racks

The door racks can be disassembled for cleaning.

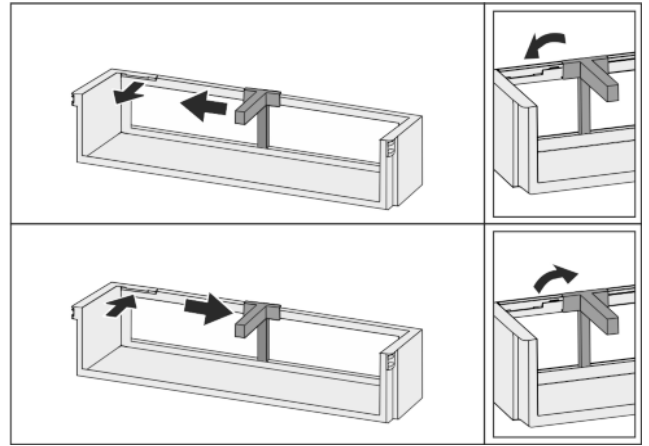

Fig. 14

- ▶ Disassemble the door racks.

7.3 Shelves

7.3.1 Moving/removing shelves

Extension stops secure the shelves against being accidentally pulled out

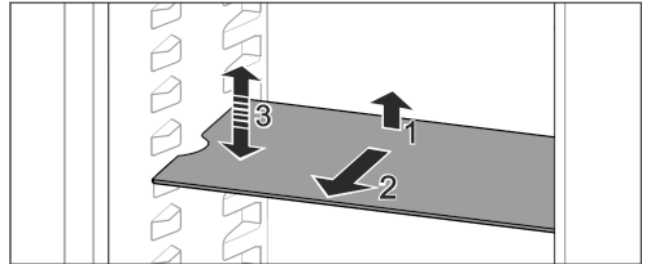

Fig. 15

- ▶ Lift the shelf and pull to the front.
- ▷ Side recess to shelf position.
- ▶ To move a shelf: set to the position you want and slide into place.

-or-

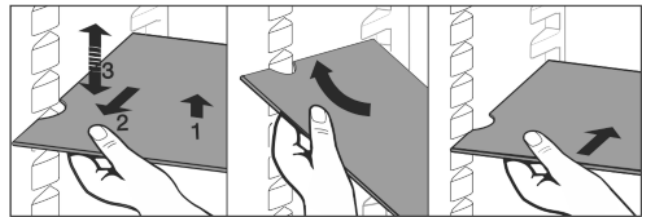

Fig. 16

- ▶ To completely remove a shelf: pull out to the front.

- ▶ Easier removal: Set the shelf at an angle.
- ▶ Reinserting the shelf: slide in until it engages.
- ▷ Pull-out stoppers are pointing down.
- ▷ Pull-out stoppers are behind the front shelf.

You can also remove the shelf above the EasyFresh compartments.

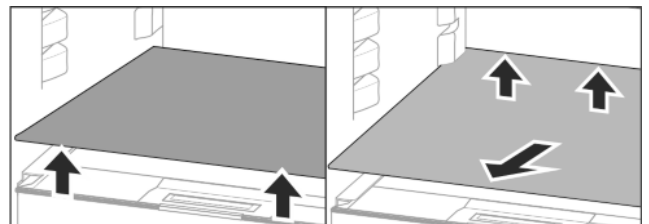

Fig. 17

To remove shelf

- ▶ Lift the shelf at the front and back.
- ▶ Remove from the front.

Do not place any goods on the drawer cover below!

Slide the shelf in:

- ▶ Place the shelf at an angle, with the back tilted downwards.
- ▷ Pull-out stoppers are pointing down.
- ▶ Slide the shelf into place.

7.3.2 Dismantling shelves

The shelves can be dismantled for cleaning.

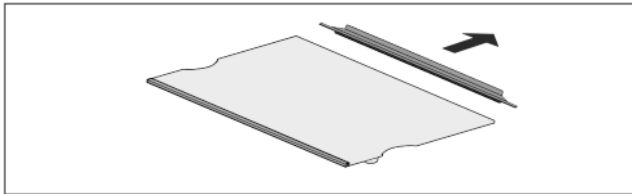

Fig. 18

- ▶ Disassemble the shelf.

7.4 Split shelf*

7.4.1 Using the split shelf

Extension stops secure the shelves against being accidentally pulled out

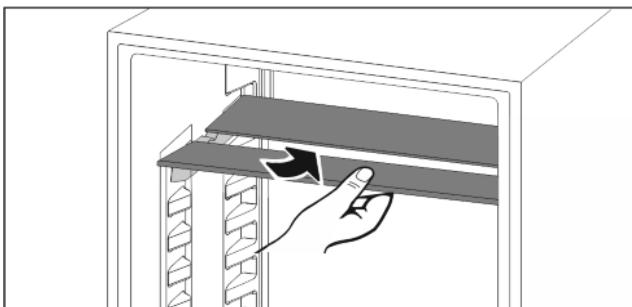

Fig. 19

- ▶ Push the split shelf underneath as in the illustration

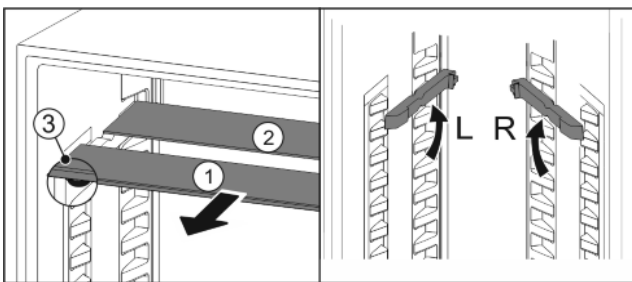

Fig. 20

Adjusting heights:

- ▶ Pull the glass panels out Fig. 20 (1) from the front, one at a time.
- ▶ Pull the support rails out of their retainers and snap into place at the height you want them.
- ▶ Slide in the glass panels one at a time.
- ▷ Flat pull-out stoppers at the front, right behind the support rail.
- ▷ Taller pull-out stoppers at the back.

Using both shelves:

- ▶ Lift the top glass plate and pull the bottom glass plate forwards.
- ▷ Glass panel Fig. 20 (1) with pull-out stoppers is at the front.
- ▷ Stoppers are pointing down Fig. 20 (3).
Appliances with freezer:*
- ▶ Do not place shelf rails and split shelves in front of the fan.*

7.5 VarioSafe*

The VarioSafe provides space for small food, packs, tubes, and jars.

7.5.1 Using the VarioSafe

You can remove the drawer and slide it back in at two different heights. This is to accommodate taller small items in the drawer.

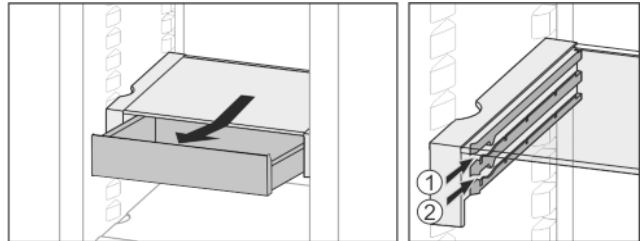

Fig. 21

- ▶ Remove the drawer.
- ▶ Slide in at any height Fig. 21 (1) or Fig. 21 (2).

7.5.2 Moving the VarioSafe

You can shift the height of the entire VarioSafe unit.

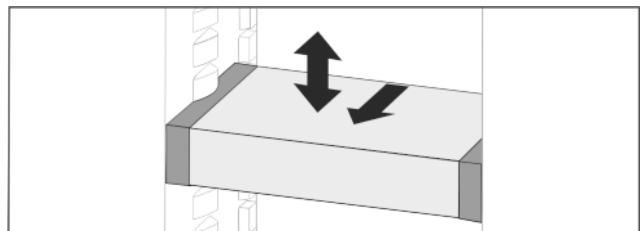

Fig. 22

- ▶ Pull to the front.
- ▷ Side recess to shelf position.
- ▶ Raise or lower to any height.
- ▶ Slide to the rear.

7.5.3 Removing the VarioSafe completely

You can remove the entire VarioSafe unit.

- ▶ Pull to the front.
- ▷ Side recess to shelf position.

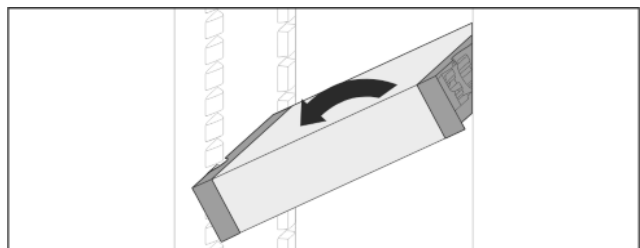

Fig. 23

- ▶ Tilt and pull to the front.

7.5.4 Disassembling the VarioSafe

The VarioSafe can be dismantled for cleaning.

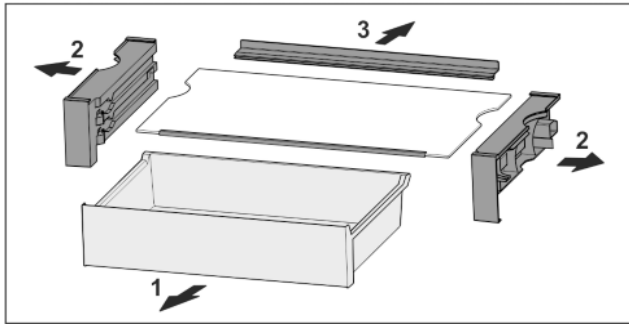

Fig. 24

- ▶ Dismantling the VarioSafe.

7.6 Space for baking tray*

There is space for a baking tray Fig. 1 (8) above the drawers.

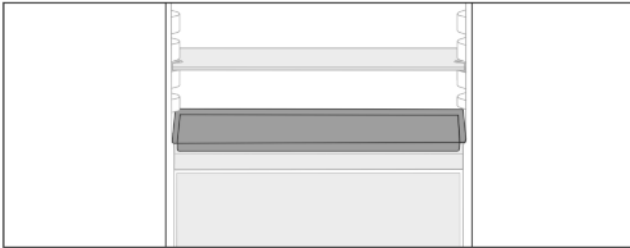

Fig. 25

Make sure that the following requirements are fulfilled

- Max. baking tray dimensions are adhered to (see 9.1 Technical specifications) .
- Baking tray has cooled to room temperature.
- The bottom door stopper is set at least one position up.

When door 90° is open:

- ▶ Slide the baking tray onto the lower side runs.

7.7 Drawers

You can remove the drawers for cleaning.

How the drawers are removed and inserted differs depending on the pull-out system. Your appliance can include a variety of pull-out systems.

7.7.1 Remove the drawer

Drawer without pull-out system

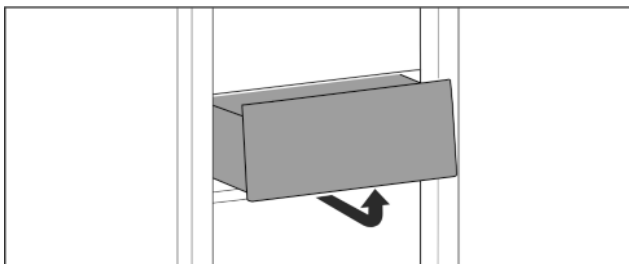

Fig. 26

- ▶ Remove the drawer as shown in the diagram.

Drawer on glide rails

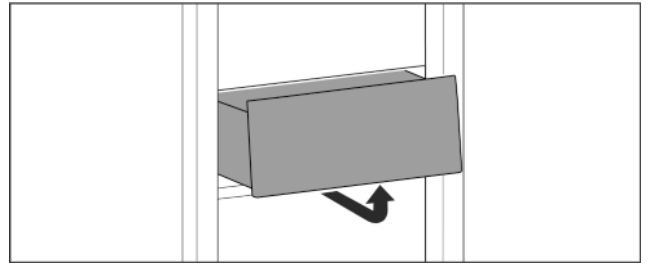

Fig. 27

- ▶ Remove the drawer as shown in the diagram.

Drawer on retractable rails

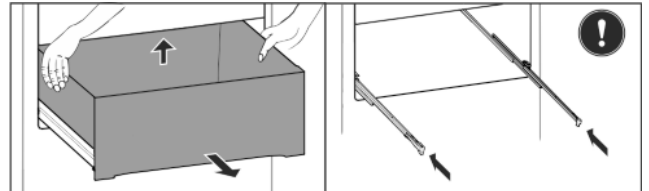

Fig. 28

- ▶ Pull out the drawer.
- ▶ Lift and pull away to the front.
- ▶ Slide the rails in.

7.7.2 Inserting the drawer

Drawer without pull-out system

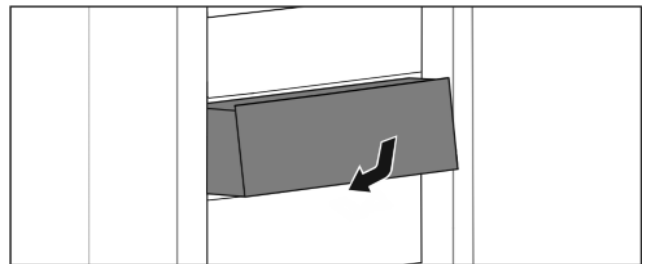

Fig. 29

- ▶ Insert the drawer as shown in the diagram.

Drawer on glide rails

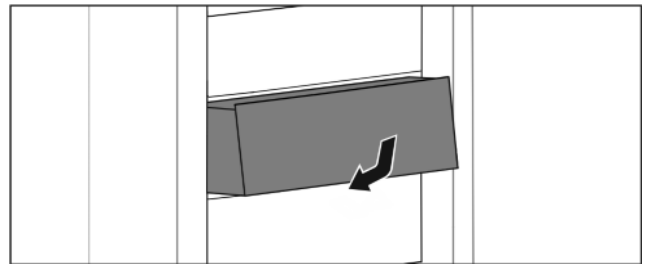

Fig. 30

- ▶ Insert the drawer as shown in the diagram.

Drawer on retractable rails

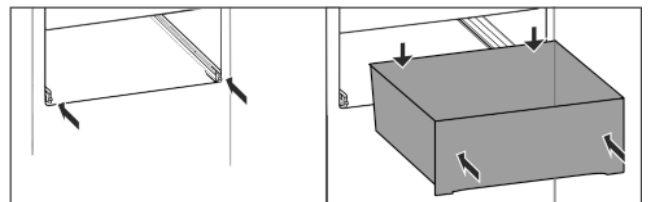

Fig. 31

- ▶ Rails are in place.
- ▶ Slide the drawer all the way to the back on the rails.
- ▶ Click into place at the back.

7.8 EasyFresh-Safe

The compartment lid can be removed for cleaning.

7.8.1 Removing the compartment lid

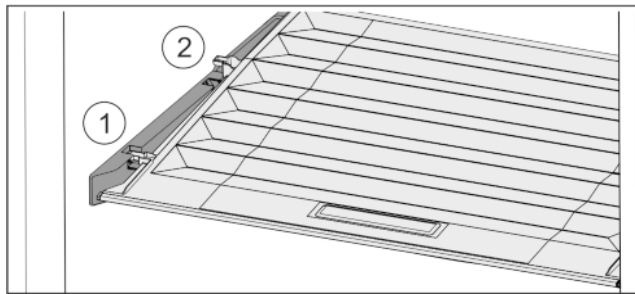

Fig. 32

If the drawers are removed:

- ▶ Pull the lid up at the front in the retaining parts to the opening Fig. 32 (1).
- ▶ Lift from the back and pull it up and out Fig. 32 (2).

7.8.2 Inserting the compartment lid

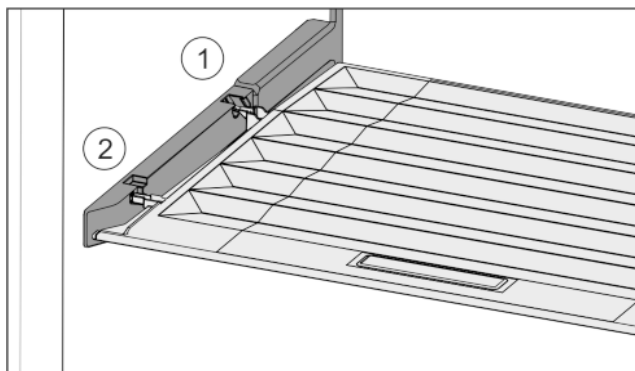

Fig. 33

- ▶ Insert the lip of the cover over the opening of the rear bracket Fig. 33 (1) and click into place Fig. 33 (2).
- ▶ Position the cover where you want it (see 7.9 Humidity control).

7.9 Humidity control

You can regulate the moisture in the drawer yourself by adjusting the compartment cover.

The compartment cover is on the drawer itself and can be covered with shelves or additional drawers.

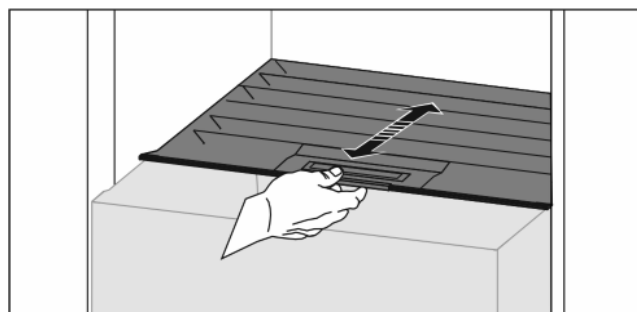

Fig. 34

Low air humidity

- ▶ Open the drawer.
- ▶ Pull the drawer cover to the front.
- ▷ If the drawer is closed: Gap between lid and compartment.
- ▷ Moisture levels lower in the Safe.

High air moisture:

- ▶ Open the drawer.

- ▶ Slide the compartment cover to the back.
- ▷ If the drawer is closed: The cover seals the compartment.
- ▷ Moisture levels rise in the Safe.
- If there is too much moisture in the compartment:
 - ▶ Choose a "low moisture setting".
 - or-
 - ▶ Remove the moisture with a cloth.

7.10 Pull-out board with bottle basket*

Removable bottle baskets on the pull-out board offer plenty of space to store bottles. You can remove the bottle baskets to make room for a drinks crate in the pull-out board.

7.10.1 Using the bottle basket

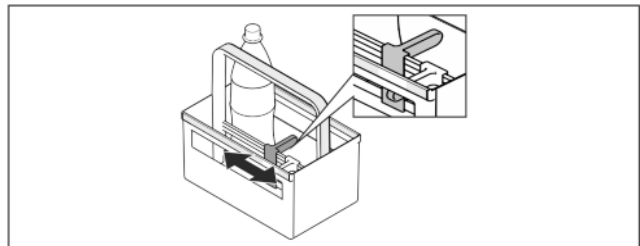

Fig. 35

- ▶ Slide the bottle rack at the edges.
- ▷ Stops bottles from tipping over.

7.10.2 Disassembling the pull-out board

The pull-out board is mounted on a glass panel with pull-out rails.

You can dismantle the pull-out board for cleaning.

Removing the pull-out board

- ▶ Remove the bottle baskets.

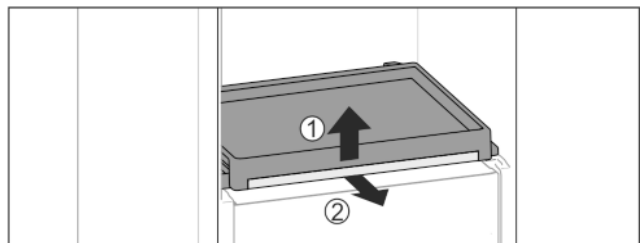

Fig. 36

- ▶ To remove the pull-out board with glass panel: Gently lift the glass panel at the front Fig. 36 (1) and pull out to the front Fig. 36 (2).

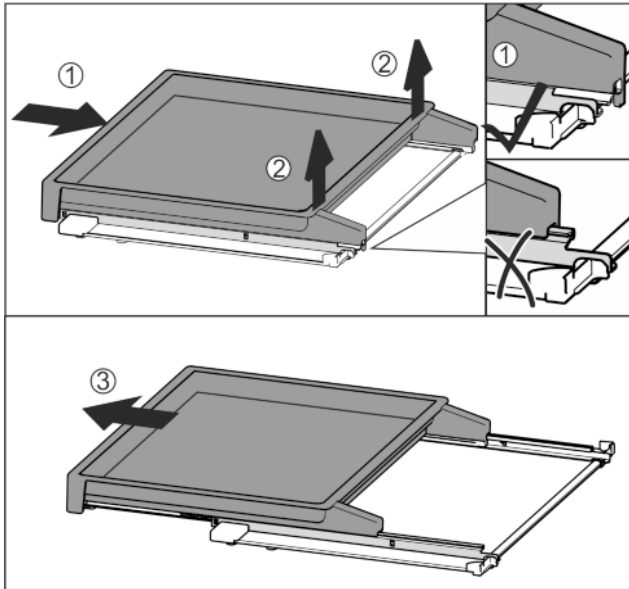

Fig. 37

- ▶ Slide the pull-out board all the way in Fig. 37 (1).
- ▶ Release the clips at the back Fig. 37 (2).
- ▶ Remove the pull-out board from the front Fig. 37 (3).

Inserting the pull-out board

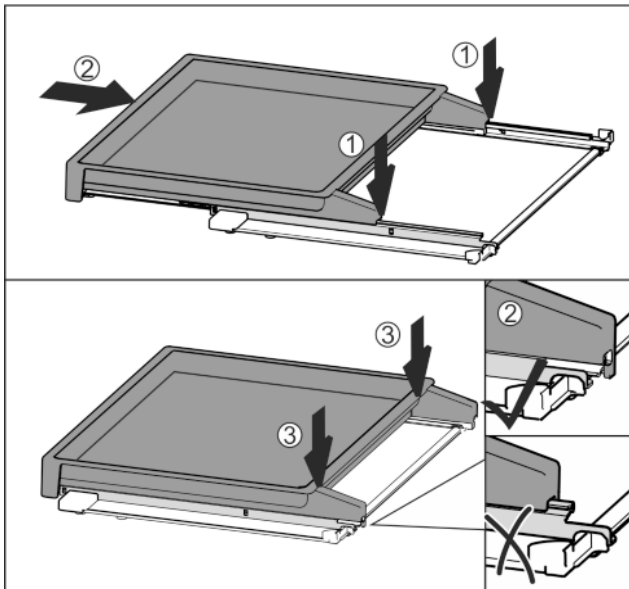

Fig. 38

- ▶ Place centrally on the rails Fig. 38 (1).
- ▶ Slide the pull-out board all the way in Fig. 38 (2).
- ▶ Press down at the back until it clicks into place Fig. 38 (3).
- ▶ To insert the pull-out board with glass panel: Slide to the rear.

7.11 Accessories

7.11.1 Bottle rack

Using the bottle rack

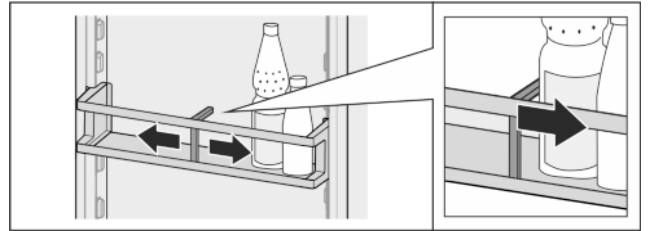

Fig. 39

- ▶ Slide the bottle rack at the edges.
- ▷ Stops bottles from tipping over.

Removing the bottle rack

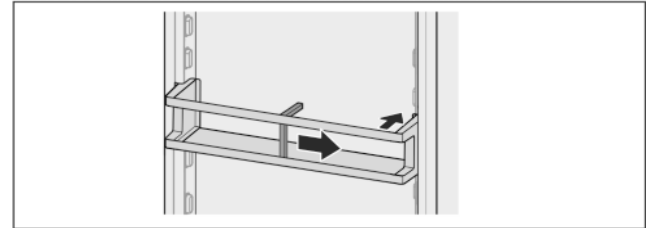

Fig. 40

- ▶ Slide the bottle rack all the way to the right edge.
- ▶ Remove to the back.

8 Maintenance

8.1 FreshAir carbon filter*

The FreshAir carbon filter is located in the compartment above the fan.

It guarantees the best air quality.

- Change the carbon filter every 6 months.
With an active *Reminder*, a change prompt appears in the display.
- You can dispose of the carbon filter with the regular household waste.

Note

The FreshAir carbon filter is available for purchase from the [Liebherr home appliance store](http://home.liebherr.com) (home.liebherr.com).

8.1.1 Removing the FreshAir carbon filter

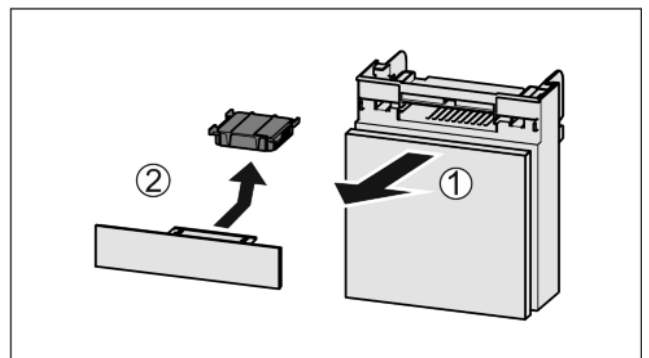

Fig. 41

- ▶ Pull out the compartment Fig. 41 (1).
- ▶ Remove the carbon filter Fig. 41 (2).

8.1.2 Inserting the FreshAir carbon filter

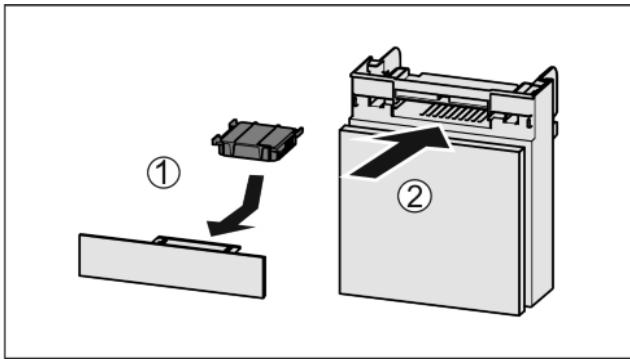

Fig. 42

- ▶ Insert the carbon filter as shown in the diagram Fig. 42 (1).
- ▷ The carbon filter clicks into place.
If the carbon filter is pointing downwards:
- ▶ Push the compartment in Fig. 42 (2).
- ▷ The carbon filter is now ready for use.

8.2 Defrost the appliance



WARNING

Appliance incorrectly defrosted!
Injuries and damage.

- ▶ Do not use mechanical devices or other means to accelerate the defrosting process, other than those recommended by the manufacturer.
- ▶ Do not use any electrical heating or steam cleaning equipment, naked flames or defrosting sprays.
- ▶ Do not remove ice with sharp objects.
- ▶ Do not damage the pipes of the refrigerant circuit.

Defrosting is automatic. The thawing water drains through the outlet and evaporates.

Water droplets or a thin layer of frost or ice can form on the rear wall; this is a completely normal part of the appliance's function. You do not have to remove them.

As the appliance regulates its energy efficiency, a layer of frost or ice can also form.

- ▶ Clean the outlet regularly (see 8.3 Cleaning the appliance).

8.2.2 Defrosting the freezer manually

After prolonged use, a layer of frost or ice can form.

The following can encourage this process.

- Door is frequently opened.
- Hot food is placed inside.
- ▶ Switch off the appliance (see 6.4 Settings).
- ▶ Disconnect the power plug or switch off the power
- ▶ Wrap the frozen food in newspaper or blankets and store in a cold place
- ▶ Put a pot with hot, not boiling, water on a middle shelf of the compartment.

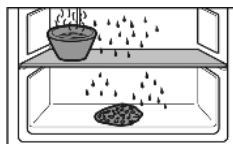

- ▷ This will speed up defrosting.
- ▶ Leave the compartment and appliance doors open during defrosting*
- ▶ Remove lumps of ice that come loose
- ▶ Make sure that the thawing water does not run into the housing cabinet.
- ▶ If necessary, soak up the water with a sponge or a cloth
- ▶ Clean the appliance (see 8.3 Cleaning the appliance).

8.3 Cleaning the appliance

8.3.1 Preparation



WARNING

Danger of electric shock.

- ▶ Unplug refrigerator or disconnect power.



WARNING

Danger of fire

- ▶ Do not damage the refrigerant circuit.

- ▶ Empty appliance.

8.3.2 Cleaning the interior

NOTICE

Improper cleaning!

Damage to the appliance.

- ▶ Only use soft cleaning cloths and ph-neutral all-purpose cleaners.

- ▶ Plastic surfaces: clean by hand with a soft clean cloth, lukewarm water and a little detergent.

- ▶ Metal surfaces: clean by hand with a soft clean cloth, lukewarm water and a little detergent.

- ▶ Drain outlet Fig. 1 (11): Remove any deposits with a thin item such as a cotton bud.

8.3.3 Cleaning the equipment

NOTICE

Improper cleaning!

Damage to the appliance.

- ▶ Only use soft cleaning cloths and ph-neutral all-purpose cleaners.

Clean with a soft, clean cloth, lukewarm water and a little washing up liquid:

- Door racks
- Shelf
- Split shelf*
- VarioSafe*
- Bottle basket and pull-out board*
- EasyFresh-Safe
- Drawer

Clean with a damp cloth:

- Retracting rails
Please note: the grease in the tracks is there for lubrication purposes and must not be removed!

Clean in the dishwasher up to 60°C:

- Bottle rack
- Holder for the split shelf
- Egg rack
- ▶ Disassemble the equipment: see the relevant section.
- ▶ Clean the equipment.

8.3.4 After cleaning

- ▶ Wipe dry the appliance and items of equipment
- ▶ Connect and switch on the appliance.
When the temperature is sufficiently cold
- ▶ Place the food inside.
- ▶ Repeat cleaning regularly.

9 Customer support

9.1 Technical specifications

Temperature zone	
Cool:	2 °C to 9 °C

Maximum freezing capacity / 24 hrs	
Freezer compartment*	See nameplate, "Freezing capacity ... / 24h"*

Max. equipment capacity			
Equipment	Appliance width 55 cm (see Installation Guide, Appliance Dimensions)	Appliance width 60 cm (see Installation Guide, Appliance Dimensions)	Appliance width 70 cm (see Installation Guide, Appliance Dimensions)
Pull-out board*	20* kg*	20* kg*	20* kg*

Max. size baking tray*	
Width	466 mm
Depth	386 mm
Height	50 mm

Lighting	
Energy efficiency class ¹	Light source
This product contains an energy efficiency class F light source	LED

¹ The appliance may contain light sources with different energy efficiency classes. The lowest class is given here.

9.2 Operating noises

The appliance makes noises while in operation.

- At **less cooling output** the appliance saves energy but takes longer to cool items. The volume is **lower**.
- At a **higher cooling output** the food cools more quickly. The volume is **higher**.

Examples:

- Activated functions (see 6.3 Functions)
- Running fan*
- Freshly sorted food

- High ambient temperature
- Door opened for long periods

Noise	Possible cause	Type of noise
Bubbling splashing and	Coolant is flowing into the cooling circuit.	Normal noise
Spitting hissing and	Coolant is spraying into the cooling circuit.	Normal noise
Humming	The appliance cools. The volume depends on the cooling output.	Normal noise
Sipping noises	The self-closing door is being opened and closed.	Normal noise
Whirring murmuring* and	The fan is running.*	Normal operating noise*
Clicking	Components are being switched on/off	Normal switching noise
Rattling humming or	Valves are active.	Normal switching noise

Noise	Possible cause	Type of noise	How to resolve
Vibration	Unsuitable installation.	Error noise	Check installation. Set up the appliance.
Clattering	Equipment, Objects inside the appliance	Error noise	Secure equipment parts. Leave a gap between items.

9.3 Technical faults



Your appliance is designed and manufactured for reliable operation and a long service life. If a malfunction nonetheless occurs during operation, please check whether the malfunction is due to an operating error. In this case, you will have to be charged for the costs incurred, even during the warranty period. You may be able to rectify the following faults yourself.

9.3.1 Appliance function

Defect	Cause	Remedy
The appliance does not work.	→ The appliance is not switched on.	▶ Switch on the appliance.
	→ The power plug is not properly inserted in the wall socket.	▶ Check the power plug.
	→ The powerfuse in the wall socket is not OK.	▶ Check the fuse.
	→ Power failure.	▶ Keep the appliance closed. ▶ Protect your food: Lay freezer packs on top of the food or use another freezer if the power is off for a prolonged period. ▶ Do not re-freeze defrosted food.

Defect	Cause	Remedy
	→ The appliance connector is not correctly inserted in the appliance.	▶ Check the appliance connector.
The temperature is not cold enough	→ This means that the door of the appliance is not closed properly	▶ Close the appliance door
	→ Insufficient ventilation	▶ Clear and clean the ventilation grille.
	→ The ambient temperature is too high	▶ Solution: (see 1.3 Range of appliance use) .
	→ The appliance was opened too frequently or for too long	▶ Wait to see whether the required temperature resets itself by itself. If not, contact Customer Service (see 9.4 Customer service) .
	→ The appliance is too near to a heat source (stove, heater etc).	▶ Change location of appliance or the heat source.
	→ The appliance was not properly installed in the recess.	▶ Make sure the appliance was installed correctly and the door closes properly.
The door seal is defective or should be replaced for other reasons.	→ The door seal is interchangeable. You can replace it without the use of any special tools.	▶ Contact Customer Service (see 9.4 Customer service) .
The appliance is iced up or condensation is building.	→ The door seal may have slipped out of its groove.	▶ Check the door seal is well placed in the groove.

9.3.2 Equipment

Defect	Cause	Remedy
The interior light does not turn on.	→ The appliance is not switched on.	▶ Switch on the appliance.
	→ The door was open for longer than 15 min.	▶ The interior light automatically switches itself off if the door stays open for approx. 15 min.
	→ The LED interior light is faulty or the cover is damaged:	<div style="border: 1px solid red; padding: 5px;"> <p> WARNING Risk of injury from electrical shock. Live parts are under the cover. ▶ The LED interior light should only be replaced or repaired by the Customer Service department or by engineers trained to do so.</p> </div> <hr/> <div style="border: 1px solid red; padding: 5px;"> <p> WARNING Risk of injury from LED lamp! The light intensity of the LED lighting corresponds to risk group RG 2. If the cover is faulty: ▶ Do not gaze directly at this lighting unit with optical lenses while very close to the light source. This can cause damage to your eyes.</p> </div>
The freezer door will not shut.*	→ The catch is locked with the door open.	▶ Try the handle again.

9.4 Customer service

First check if you can fix the error yourself (see 9 Customer support) . If this is not the case, please contact customer service.

Please refer to the enclosed “Liebherr Service” brochure for the address.



WARNING

Risk of injury from repairs by non-professionals.

▶ Repairs and work on the appliance and the power supply cable not described in the Manual (see 8 Maintenance) should only be carried out by a qualified service provider.

Decommissioning

9.4.1 Contact Customer Service

Make sure to have the following appliance information to hand:

- Appliance name (model and index)
- Service no. (service)
- Serial no. (S no.)
- ▶ Showing appliance info on the display (see Info) .
- or-
- ▶ Referring to appliance info on the nameplate (see 9.5 Rating plate) .
- ▶ Take note of the appliance information.
- ▶ Inform Customer Service: Tell us the problem and the appliance details.
- ▷ This will help us give you fast and accurate support.
- ▶ Further instructions from customer service will follow.

9.5 Rating plate

The nameplate is located behind the drawers on the inside of the appliance.

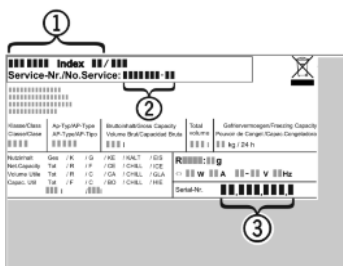

Fig. 43

- (1) Appliance name
 - (2) Service no.
 - (3) Serial no.
- ▶ Information from the nameplate.

10 Decommissioning

- ▶ Empty appliance.
- ▶ Switch off the appliance (see 6.4 Settings) .
- ▶ Pull out the power plug.
- ▶ Remove the appliance connector if necessary: Pull it out and, at the same time, move it from the left to the right.
- ▶ Clean the appliance (see 8.3 Cleaning the appliance) .
- ▶ Leave the door open to prevent bad smells

11 Disposing of the appliance

The device still contains valuable materials and must be collected separately from unsorted municipal waste so it can be recycled. Disused devices must be disposed of in a proper and professional manner according to the locally applicable regulations and laws.

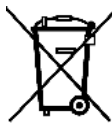

Do not damage the refrigerant circuit of the old appliance during transport. This ensures that the refrigerant (see type plate for details (see 9.5 Rating plate)) and the oil cannot leak out uncontrollably.

For Germany:

The appliance can be disposed of free of charge in Class 1 collection containers at your local recycling center. When purchasing a new fridge/freezer and if your sales area is > 400 m², the retailer will also take back the old appliance free of charge.

Decommission the appliance:

- ▶ Disconnect the power plug.
- ▶ Remove the connection cable from the appliance.



home.liebherr.com/fridge-manuals

EN Built-in refrigerator
ORIGINAL OPERATOR'S MANUAL

Issue date: 20210629
Part number index: 7088250-00

Liebherr-Hausgeräte Ochsenhausen GmbH
Memminger Straße 77-79
88416 Ochsenhausen
Deutschland