

KDD90CNE



Product family	Hood
Hood Type	Downdraft Cooker Hoods
Design	Fully integrated
Extraction	Ducted out or re-circulation possible
Electronic control	Yes
Perimeter extraction	Yes
Material	Glass
Type of steel	Brushed
EAN code	8017709305796
Aesthetics	Universal
Colour	Black
Finishing	Glass
Glass Type	Black
Serigraphy colour	Silver
Logo	Silk screen



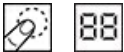

Controls



Control setting	Touch control	Display	Digital
Led colour	White		

Program / Functions

No. of speeds	4
Intensive speed	
24h air filter function	
Time-setting options	

Technical Features



Remote motor	KITRBDD - Kit Optional	Free outlet maximum capacity	725 m ³ /h
No. of lights	1	Motor power	270 W
Light type	LED	No. of filters	2
Light power	7 W	Anti-grease filters	Aluminium
Dimmer mode	Yes	Filter replacement indicator	Yes
Light colour temperature scale (°K)	4000 °K	Vent outlet	150 mm

	Extraction rate IEC 61591 [m ³ /h]	Noise level IEC 60704-2-13 [dBA]
Speed 1	160	40
Speed 2	290	53
Speed 3	350	54
Speed 4	430	60
Intensive speed	700	70

Accessories Included

Sliding door	Yes	Tube reduction	Yes
--------------	-----	----------------	-----

Performance / Energy Label



Annual Efficiency Consumption (AEChood)	58 kWh/year	Airbourne acoustical A-weighted sound Power Emission at minimum speed (SPEmin)	40 dBA
Energy efficiency class (EEC)	A	Airborne acoustical A-weighted sound Power Emission at maximum speed (SPEmax)	54 dBA
Fluid Dynamic Efficiency (FDE)	30	Airbourne acoustical A-weighted sound power emission at boost speed (SPEboost)	70 dBA
Fluid Dynamic Efficiency class (FDEC)	A	Time increase factor (F)	0.9
Lighting Efficiency (LE)	29 lux/W	Energy Efficiency Index per first cavity	53.8
Lighting Efficiency Class (LEC)	A	Measured air flow rate at best efficiency point (Qbep)	397 m ³ /h
Grease Filtering Efficiency (GFE)	65.1 %	Measured air pressure at best efficiency point (Qbep)	441 Pa
Grease Filtering Efficiency Class (GFEC)	D	Measured electric power input at best efficiency point (Wbep)	162 W
Air flow at minumum speed (Qmin)	160 m ³ /h	Normal Power of the light system (WI)	7 W
Maximum extraction rate	350 m ³ /h	Average illumination of the light on the cooking surface (Emiddle)	200 lux
Intensive extraction rate	700 m ³ /h	Sound power level at highest setting (Lwa)	54 dBA

Electrical Connection

Plug	(F;E) Schuko	Frequency (Hz)	50-60 Hz
Nominal power	277 W	Power supply cable length	1500 mm
Voltage	220-240 V		

Also available

Alternative colours available	White, Silver Glass	Available colours	KDD90VXBE - KDD90VXSE
-------------------------------	---------------------	-------------------	-----------------------

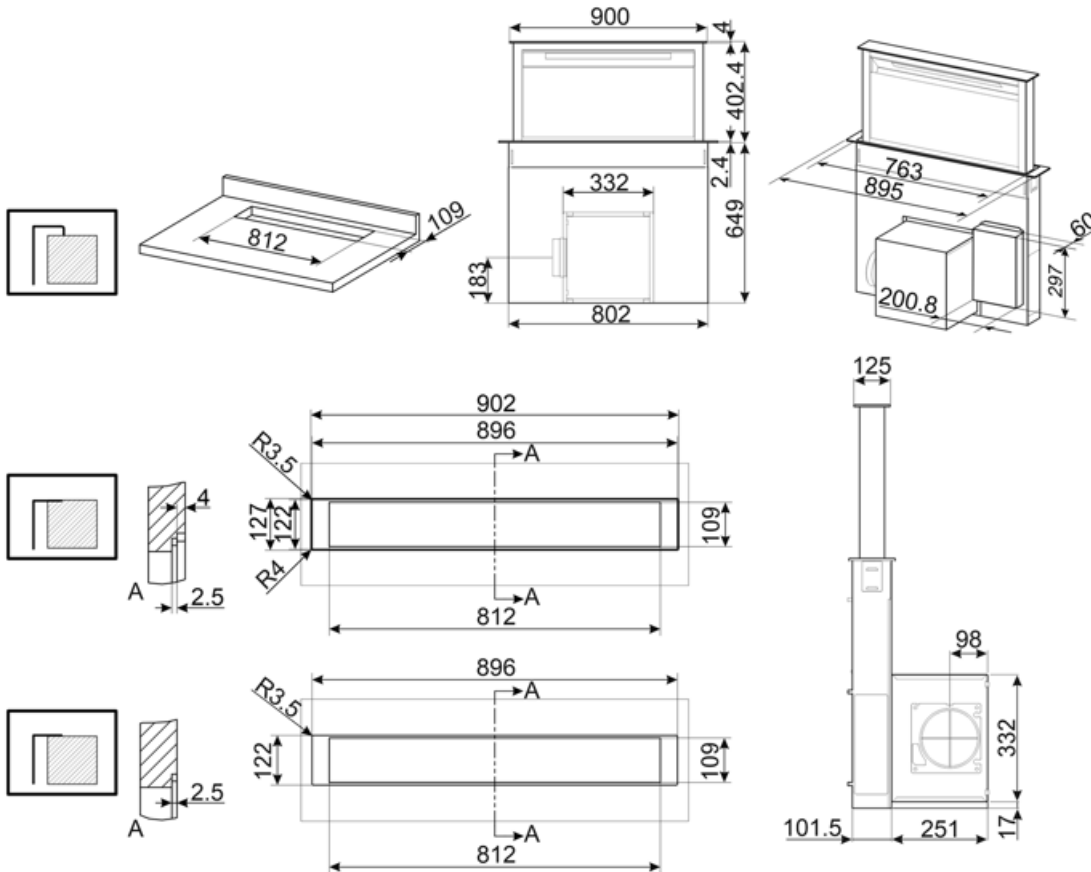

Compatible Accessories



KITFCDD

Charcoal filter for hood Down Draft Kit 1 piece Dishwasher safe













RCKF2

Remote control

KITRBDD

kit remote blower for DD hood

Symbols glossary

-  24h: When selected this function refreshes the air for c. 10 minutes every hour over a 24 hour period, at minimum speed and an imperceptible noise level.
-  Filters: Model has filters to help remove grease from the steam emanating from the pans during cooking.
-  Electronic display: to give a visual reminder of the options selected.
-  Lights: All cooker hoods feature lights to illuminate the cooking area or add to the ambience of the kitchen.
-  Touch controls: Easy to use touch controls allow the appliance to be programmed at the touch of a button.
-  ...
-  A: Product drying performance, measured from A+++ to D / G depending on the product family
-  Switch off automatically: A special setting, to run after the end of cooking for a pre-set time and then switch off automatically.
-  Warning light(s): to advise when filters need changing.
-  Perimeter extraction panels: very efficient and aid noise reduction.
-  Intensive/turbo setting: when extra fast extraction is required.

Benefit

Dimmering & Tunable lights

Customisable LED lighting lets you adjust both the intensity and colour temperature, from warm to cool tones, so you can create the perfect lighting for any mood or task

Perimetral aspiration

Enhanced extraction with a perimeter aspiration system ensures optimised performance, for a cleaner, fresher kitchen

Perimeter aspiration enhances extraction efficiency by directing vapors along the edges of the panel beneath the filters, optimizing air capture