

KDD90CNE2



Product family	Hood
Hood Type	Downdraft Cooker Hoods
Design	Fully integrated
Extraction	Ducted out or re-circulation possible
Electronic control	Yes
Perimeter extraction	Yes
Material	Painted material
EAN code	8017709346126
Hood width	90 cm
Aesthetics	Universal
Colour	Black
Finishing	Glass
Glass Type	Black
Serigraphy colour	Silver
Logo	Silk screen





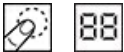

Controls



Control setting	Touch control	Display	Digital
Led colour	White		

Program / Functions

No. of speeds	4
Intensive speed	
24h air filter function	
Other functions	
 Delay_function	
Time-setting options	

Technical Features



Remote motor	KITRBDD - Kit Optional	Free outlet maximum capacity	740 m ³ /h
No. of lights	1	Motor power	250 W
Light type	LED	No. of filters	2
Light power	5 W	Anti-grease filters	Aluminium
Dimmer mode	Yes		

Light colour temperature scale (K)	4000 K	Filter replacement indicator	Yes
		Vent outlet	150 mm

	Extraction rate IEC 61591 [m³/h]	Noise level IEC 60704-2-13 [dBA]
Speed 1	200	43
Speed 2	280	49
Speed 3	350	53
Speed 4	440	57
Intensive speed	720	68

Accessories Included

Remote control	Optional	Tube reduction	Yes
Sliding door	Yes		

Performance / Energy Label



Annual Efficiency Consumption (AEChood)	57 kWh/year	Airbourne acoustical A-weighted sound Power Emission at minimum speed (SPEmin)	43 dBA
Energy efficiency class (EEC)	A	Airborne acoustical A-weighted sound Power Emission at maximum speed (SPEmax)	53 dBA
Fluid Dynamic Efficiency (FDE)	29,30	Airbourne acoustical A-weighted sound power emission at boost speed (SPEboost)	68 dBA
Fluid Dynamic Efficiency class (FDEC)	A	Time increase factor (F)	0,9
Lighting Efficiency (LE)	40 lux/W	Energy Efficiency Index per first cavity	53,1
Lighting Efficiency Class (LEC)	A	Measured air flow rate at best efficiency point (Qbep)	398 m³/h
Grease Filtering Efficiency (GFE)	65,1 %	Measured air pressure at best efficiency point (Qbep)	429 Pa
Grease Filtering Efficiency Class (GFEC)	D	Measured electric power input at best efficiency point (Wbep)	162 W
Air flow at minumum speed (Qmin)	200 m³/h	Normal Power of the light system (WI)	5 W
Maximum extraction rate	350 m³/h	Average illumination of the light on the cooking surface (Emiddle)	200 lux
Intensive extraction rate	720 m³/h	Sound power level at highest setting (Lwa)	49 dBA

Electrical Connection

Nominal power	255 W	Power supply cable length	1500 mm
Voltage	220-240 V	Plug	(F;E) Schuko
Frequency (Hz)	50-60 Hz		

Also available

Alternative colours available White, Silver Glass

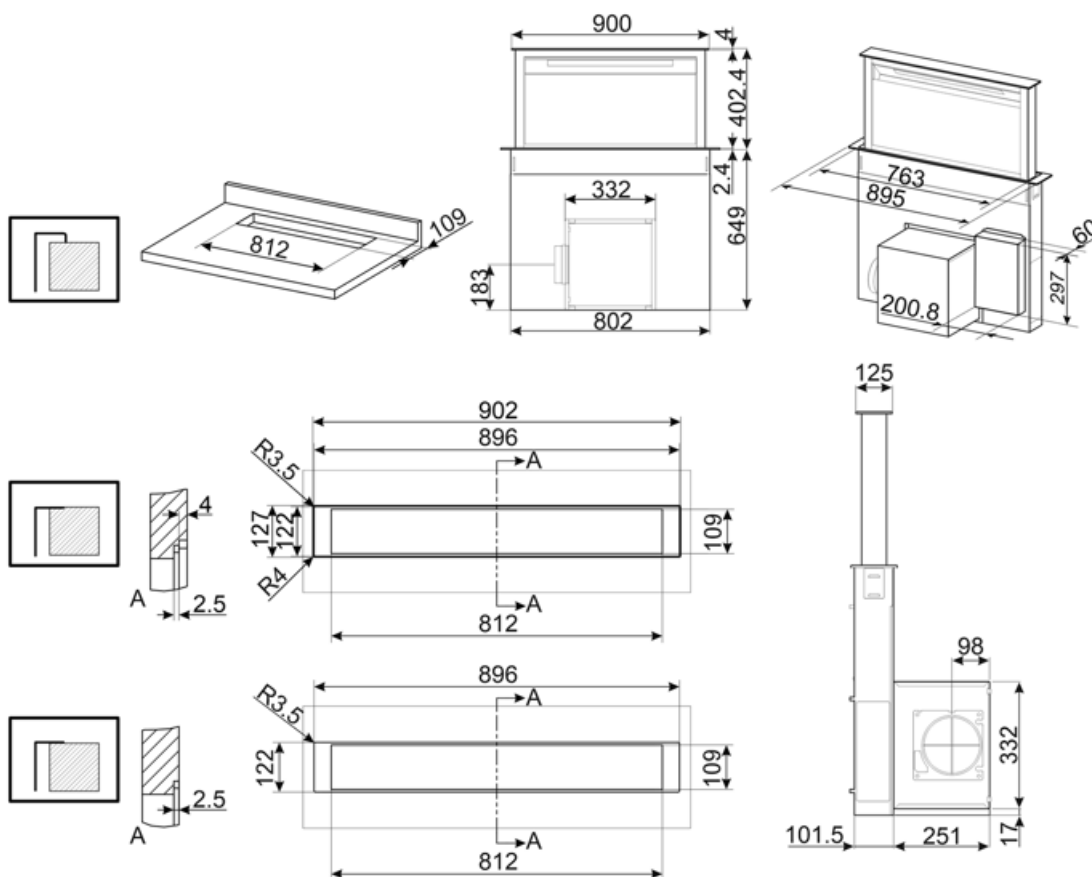

Compatible Accessories



KITFCDD

Charcoal filter for hood Down Draft Kit 1 piece Dishwasher safe















RCKF2

Remote control

KITRBDD

kit remote blower for DD hood

Symbols glossary

- | | | | |
|---|---|--|--|
|  | 24h: When selected this function refreshes the air for c. 10 minutes every hour over a 24 hour period, at minimum speed and an imperceptible noise level. |  | Filters: Model has filters to help remove grease from the steam emanating from the pans during cooking. |
|  | A: Product drying performance, measured from A+++ to D / G depending on the product family |  | Switch off automatically: A special setting, to run after the end of cooking for a pre-set time and then switch off automatically. |
|  | Delay timer: can be set to run the programme at a convenient time or to take advantage of off-peak energy periods. |  | Electronic display: to give a visual reminder of the options selected. |
|  | Warning light(s): to advise when filters need changing. |  | Lights: All cooker hoods feature lights to illuminate the cooking area or add to the ambience of the kitchen. |
|  | Perimeter extraction panels: very efficient and aid noise reduction. |  | Touch controls: Easy to use touch controls allow the appliance to be programmed at the touch of a button. |
|  | Intensive/turbo setting: when extra fast extraction is required. |  | Dimmering Lights |