

KLT12L4WH







Product family	Hood
Hood Type	Ceiling Cooker Hoods
Design	Ceiling
Extraction	Ducted out or re-circulation possible
Electronic control	Yes
Perimeter extraction	Yes
Material	Stainless steel
Type of steel	Brushed
EAN code	8017709326197
Hood width	120 cm
Aesthetics	Universal
Colour	Matte White
Finishing	Brushed
Logo	Silk screen



Controls

Control setting	Touch control back-lighted White
-----------------	-------------------------------------

Program / Functions

No. of speeds	3
Intensive speed	
24h air filter function	
Time-setting options	
Auto-Vent 2.0	

Technical Features



No. of lights	2	Anti-grease filters	Aluminium
Light type	LED	Filter replacement indicator	Yes
Light power	7.4 W	Vent outlet	150 mm
Light colour temperature range	3000 - 5700 K	Minimum distance from GAS hob	650 mm
Free outlet maximum capacity	610 m ³ /h	Minimum distance from ELECTRIC hob	650 mm
Motor power	270 W	Non return valve	Yes
No. of filters	4		

	Extraction rate IEC 61591 [m ³ /h]	Noise level IEC 60704-2-13 [dBA]
Speed 1	194	51
Speed 2	315	57
Speed 3	447	65
Intensive speed	591	71

Accessories Included

Remote control Yes

Performance / Energy Label



Annual Efficiency Consumption (AEChood)	91 kWh/year	Airbourne acoustical A-weighted sound Power Emission at minimum speed (SPEmin)	51 dBA
Energy efficiency class (EEC)	B	Airborne acoustical A-weighted sound Power Emission at maximum speed (SPEmax)	66 dBA
Fluid Dynamic Efficiency (FDE)	27.1	Airbourne acoustical A-weighted sound power emission at boost speed (SPEboost)	71 dBA
Fluid Dynamic Efficiency class (FDEC)	B	Time increase factor (F)	1.0
Lighting Efficiency (LE)	20.1 lux/W	Energy Efficiency Index per first cavity	63.0
Lighting Efficiency Class (LEC)	B	Measured air flow rate at best efficiency point (Qbep)	339.3 m ³ /h
Grease Filtering Efficiency (GFE)	62.7 %	Measured air pressure at best efficiency point (Qbep)	632 Pa
Grease Filtering Efficiency Class (GFEC)	E	Measured electric power input at best efficiency point (Wbep)	219.5 W
Air flow at mininum speed (Qmin)	194 m ³ /h	Normal Power of the light system (WI)	14.8 W
Maximum extraction rate	447 m ³ /h	Average illumination of the light on the cooking surface (Emiddle)	298 lux
Intensive extraction rate	591 m ³ /h	Sound power level at highest setting (Lwa)	66 dBA

Electrical Connection

Nominal power	305 W	Power supply cable length	1500 mm
---------------	-------	---------------------------	---------

Voltage	220-240 V	Plug	No
Frequency (Hz)	50-60 Hz		

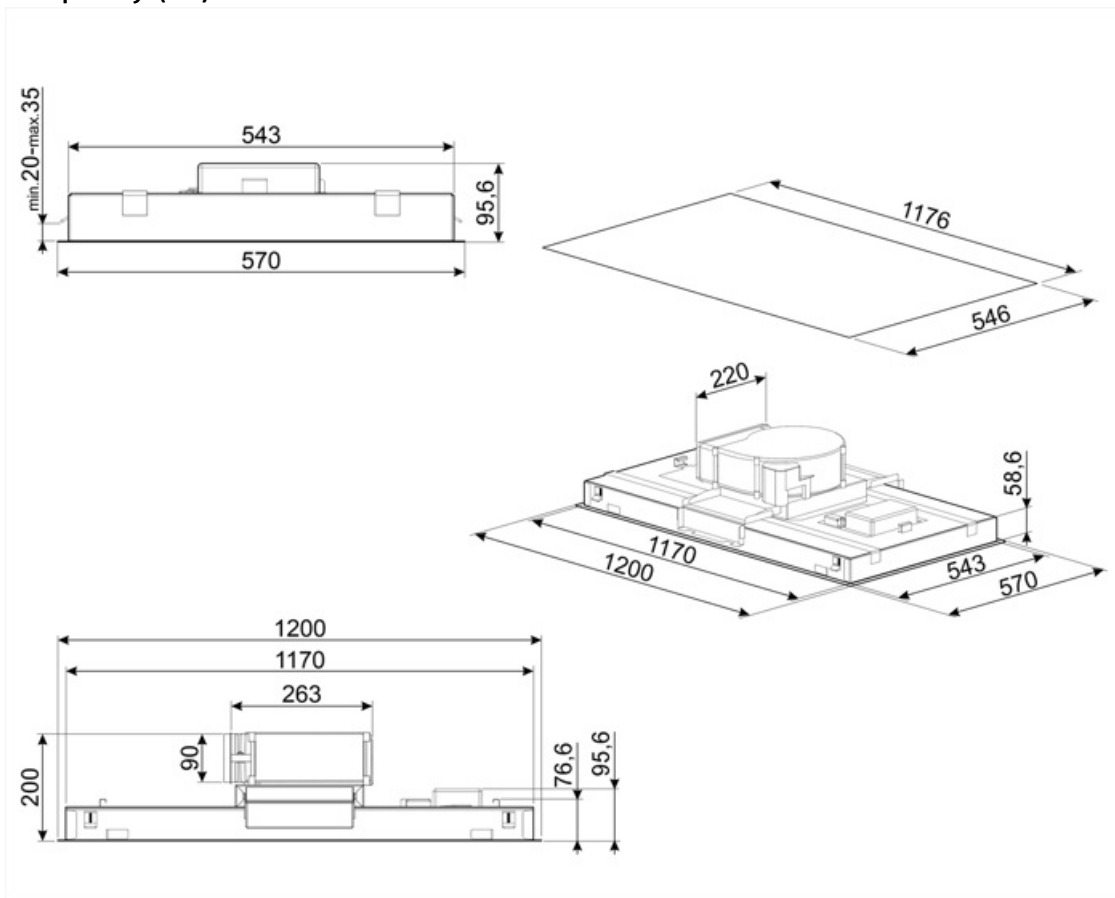

Compatible Accessories



KITALLFC

Universal Charcoal filter Stainless Steel AISI 304 The filter can be washed in dishwasher 50 °C (water and suitable detergent) and to dry it put in the oven 180°C 25 minutes



KITFCKLTR











1 pcs of Charcoal filter Regenerable* suitable for all the KLT* models. * It can be washed in the dishwasher up to 12 times and dry in the oven at max 90° for 60 min. dimension 235(H) x 200 (L) x 10 (D) mm



RRA90

Round to rectangular adapter 220x90 mm to 150 Ø

Symbols glossary

- | | | | |
|--|---|---|--|
|  | 24h: When selected this function refreshes the air for c. 10 minutes every hour over a 24 hour period, at minimum speed and an imperceptible noise level. |  | Filters: Model has filters to help remove grease from the steam emanating from the pans during cooking. |
|  | Connection between hob and hood |  | Switch off automatically: A special setting, to run after the end of cooking for a pre-set time and then switch off automatically. |
|  | |  | Warning light(s): to advise when filters need changing. |
|  | Lights: All cooker hoods feature lights to illuminate the cooking area or add to the ambience of the kitchen. |  | Perimeter extraction panels: very efficient and aid noise reduction. |
|  | Tunable white from warm to cold. |  | Intensive/turbo setting: when extra fast extraction is required. |