

# KLT12L4X

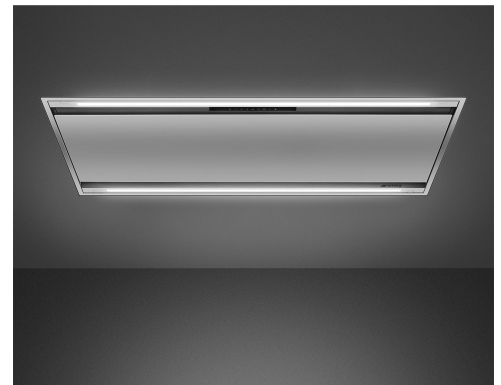





<b>Product family</b>	Hood
<b>Hood Type</b>	Ceiling Cooker Hoods
<b>Design</b>	Ceiling
<b>Extraction</b>	Ducted out or re-circulation possible
<b>Electronic control</b>	Yes
<b>Perimeter extraction</b>	Yes
<b>Material</b>	Stainless steel
<b>Type of steel</b>	Brushed
<b>EAN code</b>	8017709326203
<b>Hood width</b>	120 cm
<b>Aesthetics</b>	Universal
<b>Colour</b>	Stainless steel
<b>Finishing</b>	Brushed
<b>Logo</b>	Silk screen



## Controls

<b>Control setting</b>	Touch control back-lighted White
------------------------	-------------------------------------

## Program / Functions

<b>No. of speeds</b>	3
<b>Intensive speed</b>	
<b>24h air filter function</b>	
<b>Time-setting options</b>	
<b>Auto-Vent 2.0</b>	

## Technical Features



<b>No. of lights</b>	2	<b>No. of filters</b>	4
<b>Light type</b>	LED	<b>Anti-grease filters</b>	Aluminium
<b>Light power</b>	7.4 W	<b>Filter replacement indicator</b>	Yes
<b>Dimmer mode</b>	Yes	<b>Vent outlet</b>	150 mm
<b>Light colour temperature range</b>	3000 - 5700 K	<b>Minimum distance from GAS hob</b>	650 mm
<b>Free outlet maximum capacity</b>	610 m <sup>3</sup> /h	<b>Minimum distance from ELECTRIC hob</b>	650 mm
<b>Motor power</b>	270 W	<b>Non return valve</b>	Yes

	Extraction rate IEC 61591 [m <sup>3</sup> /h]	Noise level IEC 60704-2-13 [dBA]
Speed 1	194	51
Speed 2	315	57
Speed 3	447	65
Intensive speed	591	71

## Accessories Included

Remote control Yes

## Performance / Energy Label



Annual Efficiency Consumption (AEChood)	91 kWh/year	Airbourne acoustical A-weighted sound Power Emission at minimum speed (SPEmin)	51 dBA
Energy efficiency class (EEC)	B	Airborne acoustical A-weighted sound Power Emission at maximum speed (SPEmax)	66 dBA
Fluid Dynamic Efficiency (FDE)	27.1	Airbourne acoustical A-weighted sound power emission at boost speed (SPEboost)	71 dBA
Fluid Dynamic Efficiency class (FDEC)	B	Time increase factor (F)	1.0
Lighting Efficiency (LE)	20.1 lux/W	Energy Efficiency Index per first cavity	63.0
Lighting Efficiency Class (LEC)	B	Measured air flow rate at best efficiency point (Qbep)	339.3 m <sup>3</sup> /h
Grease Filtering Efficiency (GFE)	62.7 %	Measured air pressure at best efficiency point (Qbep)	632 Pa
Grease Filtering Efficiency Class (GFEC)	E	Measured electric power input at best efficiency point (Wbep)	219.5 W
Air flow at mininum speed (Qmin)	194 m <sup>3</sup> /h	Normal Power of the light system (WI)	14.8 W
Maximum extraction rate	447 m <sup>3</sup> /h	Average illumination of the light on the cooking surface (Emiddle)	298 lux
Intensive extraction rate	591 m <sup>3</sup> /h	Sound power level at highest setting (Lwa)	66 dBA

## Electrical Connection

Nominal power	305 W	Power supply cable length	1500 mm
---------------	-------	---------------------------	---------

---

Voltage	220-240 V	Plug	No
Frequency (Hz)	50-60 Hz		

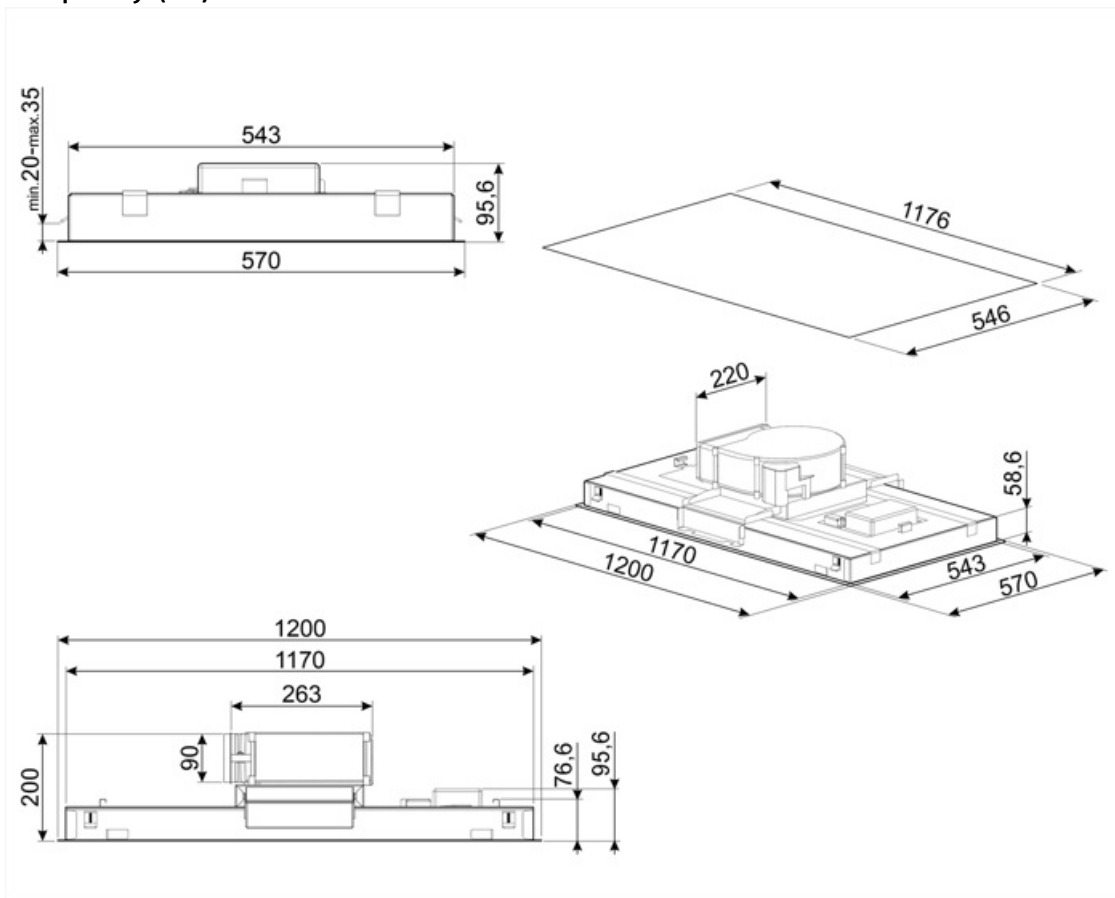

---

## Compatible Accessories

---



### KITALLFC

Universal Charcoal filter Stainless Steel AISI 304 The filter can be washed in dishwasher 50 °C (water and suitable detergent) and to dry it put in the oven 180°C 25 minutes



### KITFCKLTR

1 pcs of Charcoal filter Regenerable\* suitable for all the KLT\* models. \* It can be washed in the dishwasher up to 12 times and dry in the oven at max 90° for 60 min. dimension 235(H)x 200 (L) x 10 (D) mm













### RRA90

Round to rectangular adapter 220x90 mm to 150 Ø

---

## Symbols glossary

---

- |  |   |   |  |
|--|---|---|--|
|  | 24h: When selected this function refreshes the air for c. 10 minutes every hour over a 24 hour period, at minimum speed and an imperceptible noise level. |  | Filters: Model has filters to help remove grease from the steam emanating from the pans during cooking.                            |
|  | Connection between hob and hood   |  | Switch off automatically: A special setting, to run after the end of cooking for a pre-set time and then switch off automatically. |
|  |   |  | Dimmering Lights   |
|  | Warning light(s): to advise when filters need changing.   |  | Lights: All cooker hoods feature lights to illuminate the cooking area or add to the ambience of the kitchen.                      |
|  | Perimeter extraction panels: very efficient and aid noise reduction.  |  | Tunable white from warm to cold.   |
|  | Intensive/turbo setting: when extra fast extraction is required.  |   |  |