

KLT9L4X



Product family	Hood
Hood Type	Ceiling hood
Design	Ceiling
Extraction	Extraction
Electronic control	Yes
Perimeter extraction	Yes
Material	Stainless steel
Type of steel	Brushed
EAN code	8017709326227
Hood width	90 cm







Aesthetics

Aesthetic	Universale	Finishing	Satin
Colour	Stainless steel	Logo	Silk screen

Controls

Control setting	Touch control back-lighted White
-----------------	-------------------------------------

Programme / Functions

No. of speeds	3
Intensive speed	
24h air filter function	
Time-setting options	
Auto-vent 2.0	

Technical Features



No. of lights	2	No. of filters	3
Light type	LED	Anti-grease filters	Aluminium
Light Power	7.4 W		

Light color temperature scale (°K)	3000 °K	Filter replacement indicator	Yes
Light color temperature range	3000° - 5700° °K	Vent outlet	150 mm
Free outlet maximum capacity	610 m³/h	Minimum distance from GAS hob	650 mm
Motor power	270 W	Minimum distance from ELECTRIC hob	650 mm
		Non return valve	Yes

	Extraction rate IEC 61591 [m³/h]	Noise level IEC 60704-2-13 [dB(A)]
Speed 1	208	48
Speed 2	323	55
Speed 3	452	62
Intensive speed	594	69

Accessories Included

Remote control	Yes
----------------	-----

Performance / Energy Label

B			
Annual Efficiency Consumption (AEChood)	94 kWh/a	Airborne acoustical A-weighted sound Power Emission at maximum speed (SPEmax)	63 dB(A)
Energy efficiency class (EEC)	B	Airborne acoustical A-weighted sound power emission at boost speed (SPEboost)	69 dB(A)
Fluid Dynamic Efficiency (FDE)	25.9	Power consumption in stand-by mode (Ps)	0.49 W
Fluid Dynamic Efficiency class (FDEC)	B	Time increase factor (F)	1.1
Lighting Efficiency (LE)	25.9 lux/W	Energy Efficiency Index	68.7
Lighting Efficiency Class (LEC)	B	Measured air flow rate at best efficiency point (Qbep)	335 m³/h
Grease Filtering Efficiency (GFE)	72.0 %	Measured air pressure at best efficiency point (Pbep)	630 Pa
Grease Filtering Efficiency Class (GFEC)	D	Measured electric power input at best efficiency point (Wbep)	226 W
Air flow at minimum speed (Qmin)	208 m³/h	Nominal Power consumption of the light system (WL)	15 W
Air flow at maximum speed (Qmax)	452 m³/h		
Air flow at boost speed (Qboost)	594 m³/h		
Airborne acoustical A-weighted sound Power Emission at minimum speed (SPEmin)	48 dB(A)		

Average illumination of the light on the cooking surface (E _{middle})	303 lux
Sound power level at highest setting (L _{wa})	63 dB(A)

Electrical Connection

Electrical connection rating	305 W	Frequency (Hz)	50-60 Hz
Voltage	220-240 V	Power supply cable length	1500 mm

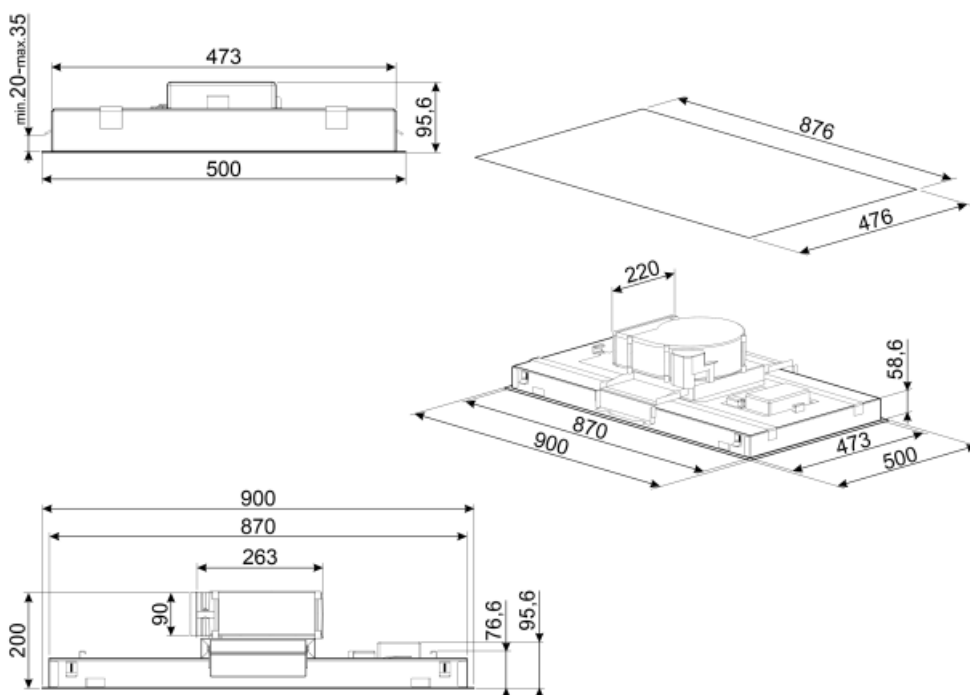

Not included accessories

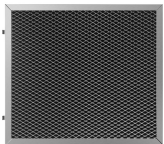

KITFCKLTR

1 pcs of Charcoal filter Regenerable* suitable for all the KLT* models. * It can be washed in the dishwasher up to 12 times and dry in the oven at max 90° for 60 min. dimension 235(H) x 200 (L) x 10 (D) mm



KITALLFC











Universal Charcoal filter Stainless Steel AISI 304 The filter can be washed in dishwasher 50 °C (water and suitable detergent) and to dry it put in the oven 180°C 25 minutes



RRA90

Round to rectangular adapter 220x90 mm to 150 Ø

Symbols glossary (TT)

- | | | | |
|--|---|---|--|
|  | 24h: When selected this function refreshes the air for c. 10 minutes every hour over a 24 hour period, at minimum speed and an imperceptible noise level. |  | Filters: Model has filters to help remove grease from the steam emanating from the pans during cooking. |
|  | Connection between hob and hood |  | Switch off automatically: A special setting, to run after the end of cooking for a pre-set time and then switch off automatically. |
|  | B: Product energy rating, measured from A+++ to D / G depending on the product family. |  | Warning light(s): to advise when filters need changing. |
|  | Lights: All cooker hoods feature lights to illuminate the cooking area or add to the ambience of the kitchen. |  | Perimeter extraction panels: very efficient and aid noise reduction. |
|  | Intensive/turbo setting: when extra fast extraction is required. |  | Tunable white from warm to cold |