

KV194G







Product family	Hood
Hood Type	Chimney Cooker Hoods
Design	Angled
Extraction	Ducted out or re-circulation possible
Electronic control	Yes
Perimeter extraction	Yes
Material	Glass
EAN code	8017709327897
Aesthetics	Linea
Colour	Neptune Grey
Finishing	Glass
Glass Type	Black
Serigraphy colour	Grey
Logo	Silk screen



Controls

Control setting	Touch control back-lighted White	Led colour	White
-----------------	-------------------------------------	------------	-------

Program / Functions

No. of speeds	3
Intensive speed	
24h air filter function	
Time-setting options	
Auto-Vent 2.0	

Technical Features

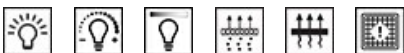

No. of lights	2	Anti-grease filters	Stainless steel
Light type	LED	Charcoal filters included	Yes
Light power	2,1 W	Filter replacement indicator	Yes
Dimmer mode	Yes	Vent outlet	150 mm
Light colour temperature range	2700° - 4000° °K	Minimum distance from GAS hob	650 mm
Free outlet maximum capacity	820 m³/h	Minimum distance from ELECTRIC hob	450 mm
Motor power	275 W	Non return valve	Yes
No. of filters	2		

	Extraction rate IEC 61591 [m³/h]	Noise level IEC 60704-2-13 [dBA]
Speed 1	277	50
Speed 2	406	63
Speed 3	636	70
Intensive speed	782	72

Performance / Energy Label



Annual Efficiency Consumption (AEChood)	41 KWh/year	Airbourne acoustical A-weighted sound Power Emission at minimum speed (SPEmin)	50 dBA
Energy efficiency class (EEC)	A+	Airborne acoustical A-weighted sound Power Emission at maximum speed (SPEmax)	71 dBA
Fluid Dynamic Efficiency (FDE)	36,2	Airbourne acoustical A-weighted sound power emission at boost speed (SPEboost)	72 dBA
Fluid Dynamic Efficiency class (FDEC)	A	Time increase factor (F)	0,7
Lighting Efficiency (LE)	34,8 lux/W	Energy Efficiency Index per first cavity	41,2
Lighting Efficiency Class (LEC)	A	Measured air flow rate at best efficiency point (Qbep)	403 m³/h
Grease Filtering Efficiency (GFE)	64,3 %	Measured air pressure at best efficiency point (Qbep)	479 Pa
Grease Filtering Efficiency Class (GFEC)	E	Measured electric power input at best efficiency point (Wbep)	148 W
Air flow at mininum speed (Qmin)	277 m³/h	Normal Power of the light system (WI)	5 W
Maximum extraction rate	636 m³/h	Average illumination of the light on the cooking surface (Emiddle)	139 lux
Intensive extraction rate	782 m³/h	Sound power level at highest setting (Lwa)	71 dBA

Electrical Connection

Nominal power	279 W	Frequency (Hz)	50-60 Hz
Voltage	220-240 V	Power supply cable length	1500 mm

Also available

Alternative colours available

Black

Available colours

KV194B3

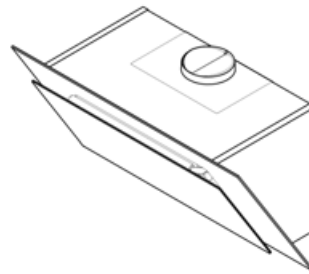
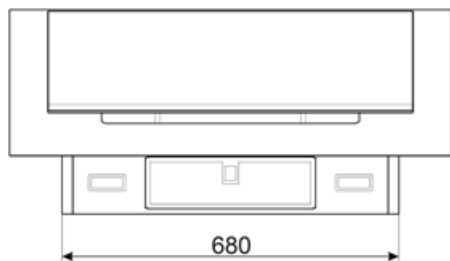
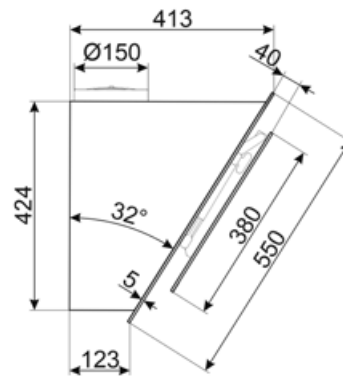
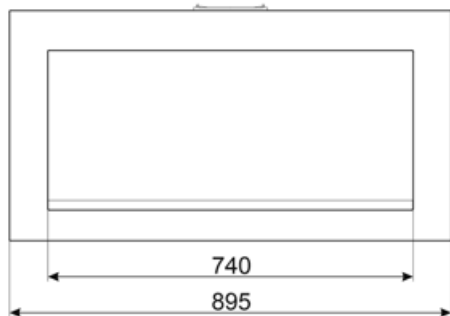

Compatible Accessories



KITALLFC

Universal Charcoal filter Stainless Steel AISI 304. The filter can be washed in dishwasher 50 °C (water and suitable detergent) and to dry it put in the oven 180°C 25 minutes



KITCMNKVX

Chimney Extension in Stainless Steel for hood KV*series



KITCMNKVMB













Chimney Extension in Stainless Steel for hood KV*series 300 mm*200 mm + 500/850 mm



KITFCKV1

Kit 2 pcs Charcoal Filter for Hood KV1*series

Symbols glossary

- | | | | |
|---|---|--|--|
|  | 24h: When selected this function refreshes the air for c. 10 minutes every hour over a 24 hour period, at minimum speed and an imperceptible noise level. |  | Filters: Model has filters to help remove grease from the steam emanating from the pans during cooking. |
|  | Connection between hob and hood |  | Switch off automatically: A special setting, to run after the end of cooking for a pre-set time and then switch off automatically. |
|  | Charcoal filters: Extracting through charcoal filters or directly to the exterior lessens strong cooking odours considerably. |  | A+: Energy efficiency class A+ helps to save up to 10% energy compared to class A. Maximum performance with minimum consumption is guaranteed. |
|  | ... |  | Warning light(s): to advise when filters need changing. |
|  | Lights: All cooker hoods feature lights to illuminate the cooking area or add to the ambience of the kitchen. |  | Perimeter extraction panels: very efficient and aid noise reduction. |
|  | ... |  | Intensive/turbo setting: when extra fast extraction is required. |

Benefit

Perimetral aspiration

Enhanced extraction with a perimeter aspiration system ensures optimised performance, for a cleaner, fresher kitchen

Perimeter aspiration enhances extraction efficiency by directing vapors along the edges of the panel beneath the filters, optimizing air capture

Dimmering & Tunable lights

Customisable LED lighting lets you adjust both the intensity and colour temperature, from warm to cool tones, so you can create the perfect lighting for any mood or task

Touch display back lighted white

Intuitive and immediate usability thanks to the elegant white LED backlit touch display

Autovent 2.0

Centralised and practical control via Bluetooth connection between hob and hood, letting you manage extraction automatically while you cook.

The Auto-Vent 2.0 system enables automatic hood management through connection with the hob: both appliances switch on simultaneously, and the extraction power adjusts in real time to the cooking intensity.