

AEG



aeg.com/register



OS6PB50AK
OS6PB50AM

INSTALLATION

(*mm)

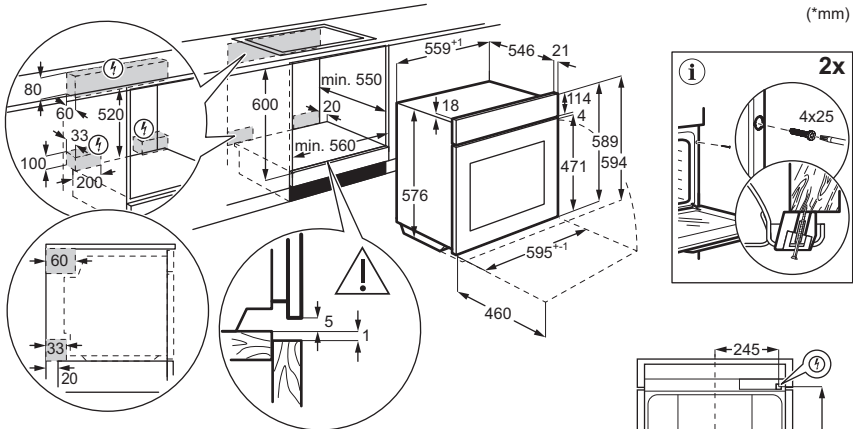

YouTube

www.youtube.com/electrolux
www.youtube.com/aeg

How to install your AEG/Electrolux
 Oven with Hob - Built Under installation

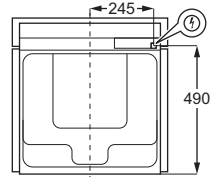

(*mm)

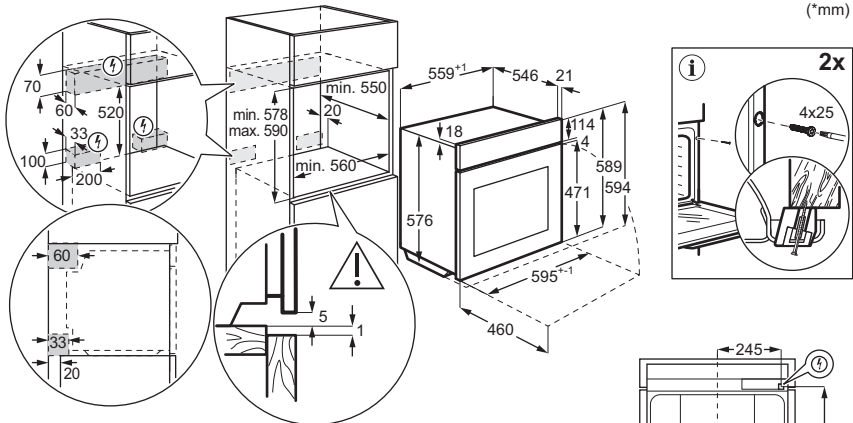

YouTube

www.youtube.com/electrolux
www.youtube.com/aeg

How to install your AEG/Electrolux
 Oven - Column installation

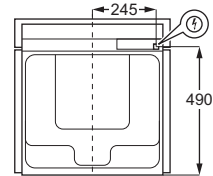
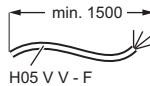

1. SAFETY INFORMATION.....	3
2. SAFETY INSTRUCTIONS.....	4
3. PRODUCT DESCRIPTION.....	7
4. BEFORE FIRST USE.....	7
5. DAILY USE.....	8

6. HINTS AND TIPS.....	12
7. CARE AND CLEANING.....	13
8. TROUBLESHOOTING.....	14
9. ENERGY EFFICIENCY.....	15
10. ENVIRONMENTAL CONCERNS.....	16

1. SAFETY INFORMATION

Before the installation and use of the appliance read the supplied instructions carefully. The manufacturer is not responsible for any injuries or damage that result from incorrect installation or usage. Always keep the instructions in a safe and accessible location for future reference.

1.1 Children and vulnerable people safety

- This appliance can be used by children aged from 8 years and above and persons with reduced physical, sensory or mental capabilities or lack of experience and knowledge if they have been given supervision or instruction concerning the use of the appliance in a safe way and understand the hazards involved. Children of less than 8 years of age and persons with very extensive and complex disabilities shall be kept away

- from the appliance unless continuously supervised.
- Children should be supervised to ensure that they do not play with the appliance.
- Keep packaging away from children and dispose of it properly.
- **WARNING:** The appliance and its accessible parts become hot during use. Keep children and pets away during use and cooling.
- Activate the child safety device, if available.
- Children must not clean or maintain the appliance without supervision.

1.2 General Safety

- This appliance is for cooking purposes only.
- This appliance is designed for single household domestic use in an indoor environment.
- This appliance may be used in offices, hotel guest rooms, bed & breakfast guest rooms, farm guest

houses, and other similar accommodation where such use does not exceed average domestic usage levels.

- Do not use the appliance before installing it in the built-in structure.
- Disconnect the appliance from the power supply before carrying out any maintenance.
- If the supply cord is damaged, it must be replaced by the manufacturer, its authorised service centre or similarly qualified persons to avoid an electrical hazard.
- The means for disconnection must be incorporated in the fixed wiring in accordance with the wiring rules.
- **WARNING:** Ensure that the appliance is switched off before replacing the lamp to avoid the possibility of electric shock.
- **WARNING:** The appliance and its accessible parts become hot during use. Care

should be taken to avoid touching heating elements or the surface of the appliance cavity.

- Always use oven gloves to remove or insert accessories or ovenware.
- Use only the food sensor (core temperature sensor) recommended for this appliance.
- To remove the shelf supports first pull the front of the shelf support and then the rear end away from the side walls. Install the shelf supports in the opposite sequence.
- Do not use a steam cleaner to clean the appliance.
- Do not use harsh abrasive cleaners or sharp metal scrapers to clean the glass door since they can scratch the surface, which may result in shattering of the glass.
- Before pyrolytic cleaning, remove all accessories and excessive deposits/spills from the appliance cavity.

2. SAFETY INSTRUCTIONS

2.1 Installation

WARNING!

Only a qualified person must install this appliance.

- Remove all the packaging.
- Do not install or use a damaged appliance.
- Follow the installation instructions available on our website.

- Be careful when moving the appliance, as it is heavy. Use safety gloves and enclosed footwear.
- Do not pull the appliance by the handle.
- Install the appliance in a safe and suitable location that meets installation requirements.
- Keep the minimum distance from other appliances and units.
- Before mounting the appliance, ensure it is level and that the door opens without any restraint.
- The appliance is equipped with an electric cooling system. It must be operated with the electric power supply.

2.2 Electrical connection

WARNING!

Risk of fire and electric shock.

- All electrical connections should be made by a qualified electrician.
- Make sure the parameters on the rating plate are compatible with the electrical ratings of the mains power supply.
- The appliance must be earthed. Always use a correctly installed shockproof socket.
- Do not use multi-plug adapters and extension cables.
- Avoid damaging the mains plug and cable. If replacement is needed, it must be done by our Authorized Service Centre.
- Do not let mains cables touch or come near the appliance door or the niche below, especially when it operates or the door is hot.
- Shock protection of live and insulated parts must be fastened securely and should not be removable without tools.
- Connect the mains plug to the socket only at the end of installation. Ensure access to the mains plug after installation.
- If the mains socket is loose, do not connect the mains plug.
- Do not disconnect the appliance by pulling on the mains cable. Always pull on the mains plug.
- Use only correct isolation devices: line protecting cut-outs, fuses (screw type fuses removed from the holder), earth leakage trips and contactors.
- The electrical installation must have an isolation device that disconnects the appliance from the mains at all poles, with a contact opening width of at least 3 mm.

- Fully close the appliance door before you connect the mains plug to the mains socket.
- This appliance is supplied without a main plug and a main cable.

2.3 Use

WARNING!

Risk of injury, burns and electric shock or explosion.

- Do not change the specification of the appliance.
- Ensure ventilation openings are not blocked.
- Do not let the appliance stay unattended during operation.
- Deactivate the appliance after each use.
- Be careful when opening the appliance door during operation, as hot air and flammable mixtures from alcohol ingredients can be released.
- Do not operate the appliance with wet hands or when it comes in contact with water.
- Do not apply pressure on the open door.
- Do not use the appliance as a work surface or as a storage surface.
- Keep sparks and open flames away from the appliance when the door is open.
- Use only approved glass and jars for preserving.
- Do not place flammable products near the appliance.

WARNING!

Risk of damage to the appliance.

- To prevent damage or discoloration to the enamel:
 - do not place ovenware or objects directly on the cavity bottom.
 - do not place aluminum foil directly on the cavity bottom.
 - do not put water directly into the hot appliance.
 - do not leave moist dishes and food in the appliance after cooking.
 - be careful when removing or installing accessories.
- Enamel or stainless steel discoloration does not affect performance of the appliance.
- Use a deep pan for moist cakes, as fruit juices can cause permanent stains.
- Always cook with the appliance door closed.

- If the appliance is installed behind a furniture panel, do not close the panel during use or until the appliance is fully cooled to prevent heat and moisture damage.
- Concerning the lamp(s) inside this product and spare part lamps sold separately: These lamps are intended to withstand extreme physical conditions in household appliances, such as temperature, vibration, humidity, or are intended to signal information about the operational status of the appliance. They are not intended to be used in other applications and are not suitable for household room illumination.
- This product contains a light source of energy efficiency class G.
- Use only lamps with the same specifications.
- To repair the appliance contact the Authorised Service Centre. Use original spare parts only.

2.4 Care and cleaning

WARNING!

Risk of injury, fire, or damage to the appliance.

- Before maintenance, deactivate the appliance and unplug it from the mains.
- Ensure the appliance is cold to avoid glass breakage. If the door glass panels are damaged, contact the authorized service centre for replacement.
- Be careful when you remove the door from the appliance, it is heavy.
- Clean and dry the appliance, its cavity, and accessories after each use to prevent steam condensation, corrosion, and surface deterioration.
- Use a microfibre cloth, warm water, and neutral detergents for cleaning the appliance and accessories. Do not use abrasive products, pads, solvents, sharp-edged or metal objects.
- Follow safety instructions on packaging when using an oven spray.

Pyrolytic cleaning

- Read all instructions for pyrolytic cleaning

- Before carrying out the pyrolytic cleaning and initial preheating remove from the oven cavity:
 - any excess food residues, oil or grease spills / deposits.
 - any removable objects (including shelves, side rails, etc., provided with the appliance) especially any non-stick pots, pans, trays, utensils, etc.
- Keep children away during pyrolytic cleaning, as the appliance becomes very hot and releases hot air from the front vents.
- Pyrolytic cleaning releases fumes from cooking residues and construction materials. Ensure good ventilation during and after the initial preheating and pyrolytic cleaning.
- Do not spill or apply water on the oven door during and after the pyrolytic cleaning to avoid damaging the glass panels.
- Fumes from pyrolytic ovens / cooking residues are not harmful to humans, including children, or persons with medical conditions.
- Keep pets away from the appliance during and after pyrolytic cleaning and the initial preheating phase. Small pets (especially birds and reptiles) can be highly sensitive to temperature changes and emitted fumes.
- Non-stick surfaces on pots, pans, trays, and utensils can be damaged by high-temperature pyrolytic cleaning and may release low-level harmful fumes.

2.5 Disposal

WARNING!

Risk of injury or suffocation.

- Contact your municipal authority for information on how to dispose of the appliance.
- Disconnect the appliance from the mains, then cut off and dispose of the electrical cable.

3. PRODUCT DESCRIPTION

3.1 General overview

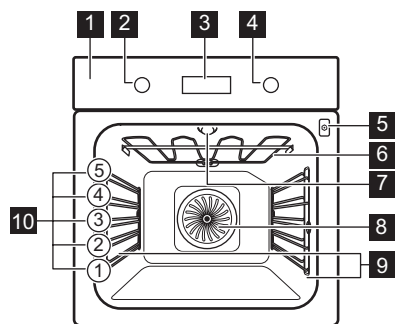

- 1 Control panel
- 2 Knob for the heating functions
- 3 Display
- 4 Control knob
- 5 Socket for the food sensor
- 6 Heating element
- 7 Lamp
- 8 Fan
- 9 Shelf support, removable
- 10 Shelf positions

3.2 Control panel

	Press to set timer functions.
	Press to set: Fast Heat Up.
	Press to turn the appliance lamp on and off.
	Press to set the food core temperature with: Food Sensor.

Press to confirm your selection.

Display indicators

	The appliance is locked.
	Submenu: Assisted Cooking.
	Submenu: Cleaning.
	Submenu: Settings
	Fast Heat Up is activated.
	Food Sensor is activated.
	Minute minder is activated.
	Cooking time is activated.
	Time Delayed Start is activated.
	Uptimer is activated.
	Progress bar - visually indicates when the appliance reaches the set temperature or when the cooking time comes to an end.

To turn on the appliance:

1. Press the knobs. The knobs come out (selected models only).
 2. Turn the knob for the heating functions to select a function.
 3. Turn the control knob to adjust settings.
- To turn off the appliance: turn the knob for the heating functions to the off position 0.

4. BEFORE FIRST USE



4.1 Setting the time

After the first connection to the mains, wait until the display shows: "00:00" or "12:00" (depending on the model).

1. Turn the control knob to set the time.
2. Press OK.

4.2 Initial preheating and cleaning

1. Preheat the empty appliance to remove any odours. Ventilate the room.
2. Remove all accessories and shelf supports.
3. Set each function to maximum temperature and let the appliance operate











for specified durations:  1 h,  15 min,  15 min. Refer to Daily use.

4. Turn off the appliance and let it cool down.

5. Clean with a microfiber cloth, warm water, and mild detergent. Replace accessories and shelf supports.

5. DAILY USE

5.1 Heating functions

- | | |
|--|--|
|  | True Fan Cooking: Even baking, tenderness, drying |
|  | Conventional Cooking: Traditional baking |
|  | Frozen Foods: French fries, potato wedges, spring rolls |
| 
 | Pizza Function / AirFry: Baking pizza / Frying food with less oil and without baking paper. |
|  | Bottom Heat: Baking cakes |
|  | Defrost: Defrosting |
|  | Moist Fan Baking: Baking |
|  | Grill: Toasting, grilling |
|  | Turbo Grilling: Roasting meat, browning |

The lamp may turn off automatically at a temperature below 80°C during some oven functions.

5.2 Setting: Heating functions

1. Turn the knob for the heating functions to select a heating function.
2. Turn the control knob to set the temperature.

» Fast Heat Up - press and hold to shorten the heating time. It is available for some heating functions. Fan may turn on automatically.

5.3 Timer

1. Turn the knobs to select the heating function and to set the temperature, if needed.
2. Press  until the display shows a desired timer function:

 **Minute minder:** Set a countdown. When the timer ends, the signal sounds.



Cooking time: Set a countdown. When the timer ends, the signal sounds and the cooking stops.

 **Time Delayed Start:** To postpone the start and / or end of cooking.

3. Turn the control knob to set the time.
4. Press OK.
5. When the time ends, press OK and turn the knobs to the off position, if needed.

5.4 Entering: Menu

Open the Menu to access Assisted Cooking dishes and settings.



1. Turn the knob for the heating functions to .

The display shows , , .

2. Turn the control knob and select the icon to enter submenu. Press OK.

5.5 Setting: Assisted Cooking

Assisted Cooking submenu consists of programmes that are designed for dedicated dishes. Programmes start with a suitable setting. You can adjust the time and the temperature during cooking.

1. Turn the knob for the heating functions to .
2. Turn the control knob to select . Press OK.
3. Turn the control knob to select a dish (P1 - P...). Press OK.
4. Place the food inside the appliance. Press OK.
5. When the function ends, check if the food is ready. Extend the cooking time, if needed.

Submenu: Assisted Cooking

Legend



Food sensor must be connected in order to use the function. Refer to Food Sensor.



Preheat the appliance before you start cooking.



Shelf level. Refer to Product description.

The display shows **P** and a **number** of the dish that you can check in the table.

P1	Roast beef, rare	2; baking tray 1 - 1.5 kg; 4 - 5 cm thick
P2	Roast beef, medium	Fry the meat for a few minutes in a hot pan. Insert to the appliance.
P3	Roast beef, well done	
P4	Steak, medium , 180 - 220 g per piece; 3 cm thick	3; roasting dish on wire shelf Fry the meat for a few minutes in a hot pan. Insert to the appliance.
P5	Beef roast / braised (prime rib, thick flank) 1.5 - 2 kg	2; roasting dish on wire shelf Fry the meat for a few minutes in a hot pan. Add liquid. Insert to the appliance.
P6	Roast beef, rare ¹⁾	2; baking tray 1 - 1.5 kg; 4 - 5 cm thick
P7	Roast beef, medium ¹⁾	Fry the meat for a few minutes in a hot pan. Insert to the appliance.
P8	Roast beef, well done ¹⁾	
P9	Fillet of beef, rare ¹⁾	2; baking tray 0,5 - 1.5 kg; 5 - 6 cm thick
P10	Fillet of beef, medium ¹⁾	Fry the meat for a few minutes in a hot pan. Insert to the appliance.
P11	Fillet of beef, done ¹⁾	
P12	Veal roast (e.g. shoulder)	2; roasting dish on wire shelf , 0.8 - 1.5 kg; 4 cm thick Add liquid. Roast covered.

Pork roast neck or shoulder, 1.5 - 2 kg

P13 2; roasting dish on **wire shelf**
Turn the meat after half of the cooking time.

Pulled pork ¹⁾, 1.5 - 2 kg

P14 2; **baking tray**
Turn the meat after half of the cooking time to get an even browning.

Pork loin, 1 - 1.5 kg; 5 - 6 cm thick

P15 2; roasting dish on **wire shelf**

Pork spare ribs, 2 - 3 kg; use raw, 2 - 3 cm thick

P16 3; **deep pan**
Add liquid to cover the bottom of a dish. Turn the meat after half of the cooking time.

Lamb leg with bones, 1.5 - 2 kg; 7 - 9 cm thick

P17 2; roasting dish on **baking tray**
Add liquid. Turn the meat after half of the cooking time.

Whole chicken, 1 - 1.5 kg; fresh

P18 2; casserole dish on **baking tray**
Turn the chicken after half of the cooking time to get an even browning.

P19 **Half chicken**, 0.5 - 0.8 kg

3; **baking tray**

Chicken breast, 180 - 200 g per piece

P20 2; casserole dish on **wire shelf**
Fry the meat for a few minutes in a hot pan.

Chicken legs, fresh

P21 3; **baking tray**
If you marinated chicken legs first, set lower temperature and cook them longer.

Duck, whole, 2 - 3 kg

P22 2; roasting dish on **wire shelf**
Put the meat on roasting dish. Turn the duck after half of the cooking time.

Goose, whole, 4 - 5 kg

P23 2; **deep pan**
Put the meat on deep baking tray. Turn the goose after half of the cooking time.

P24	Meat loaf , 1 kg 2; wire shelf
P25	Whole fish, grilled , 0.5 - 1 kg per fish 2; baking tray Fill the fish with butter, spices and herbs.
P26	Fish fillet 3; casserole dish on wire shelf
P27	Cheesecake 2; \emptyset 28 cm springform tin on wire shelf
P28	Apple cake 3; baking tray
P29	Apple tart 2; pie form on wire shelf
P30	Apple pie 1; \emptyset 22 cm pie form on wire shelf
P31	Brownies , 2 kg of dough 3; deep pan
P32	Muffins 3; muffin tray on wire shelf
P33	Loaf cake 2; loaf pan on wire shelf
P34	Baked potatoes , 1 kg 2; baking tray Use whole potatoes with skin on.
P35	Wedges , 1 kg 3; baking tray lined with baking paper Cut potatoes into pieces.
P36	Grilled mixed vegetables , 1 - 1.5 kg 3; baking tray lined with baking paper Cut the vegetables into pieces.
P37	Croquettes, frozen , 0.5 kg 3; baking tray
P38	Pommes, frozen , 0.75 kg 3; baking tray
P39	Meat / vegetable lasagna with dry pasta sheets , 1 - 1.5 kg 2; casserole dish on wire shelf

P40	Potato gratin (raw potatoes) 1 - 1.5 kg 1; casserole dish on wire shelf Rotate the dish after half of the cooking time.
P41	Pizza fresh, thin 2; baking tray lined with baking paper
P42	Pizza fresh, thick 2; baking tray lined with baking paper
P43	Quiche 2; baking tin on wire shelf
P44	Baguette / Ciabatta / White bread , 0.8 kg 2; baking tray lined with baking paper More time needed for white bread.
P45	Whole grain / Rye / Dark bread , 1 kg 2; baking tray lined with baking paper / loaf pan on wire shelf

1) Low temperature cooking.

5.6 Changing: Settings

- Turn the knob for the heating functions to .
- Turn the control knob to select . Press OK.
- Turn the control knob to select the setting. Press OK.
- Turn the control knob to adjust the value. Press OK.
- Turn the knob for the heating functions to the off position to exit Menu.

Submenu: Settings

Setting	Value
01 Time of day	Change
02 Display brightness	1 - 5
03 Key tones	1 - Beep, 2 - Click, 3 - Sound off
04 Buzzer volume	1 - 4
05 Food Sensor Action	1 - Alarm and stop, 2 - Alarm

Setting	Value
06 Uptimer	On / Off
07 Light	On / Off
08 Fast Heat Up	On / Off
09 Cleaning Reminder	On / Off
10 Demo mode	Activation code: 2468
11 Software version	Check
12 Reset all settings	Yes / No

5.7 Lock

This function prevents an accidental change of the appliance function.

When activated while the appliance is in use, it locks the control panel, ensuring that the current cooking settings continue uninterrupted.

When activated while the appliance is off, it keeps the control panel locked, preventing the appliance from being turned on unintentionally.

 **OK** - press and hold to turn on and off the function.

A signal sounds.  - flashes 3 times when the lock is turned on. The appliance door is locked.

5.8 Accessories



Accessories available depending on model. Scan the QR code to check how to use accessories supplied with your appliance. You can order optional accessories separately. For more information, please contact your local supplier.

A small indentation at the top increases safety and provides tilt protection. The rim around the shelf prevents cookware from slipping off the shelf.

Insert the accessory (wire shelf / tray) between the guide bars of the shelf support. Make sure that the shelf touches the back of the oven interior.

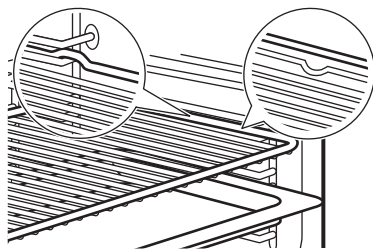

If your tray has a slope, position it towards the back of the oven interior.

If there is an inscription on the accessory, make sure it is facing you.

If you are using a tray with holes, place the tray / pan underneath to collect dripping liquids.

5.9 Food Sensor

It measures the temperature inside the food.

There are two temperatures to be set:

- $^{\circ}\text{C}$ - the oven temperature. It should be at least 25°C higher than the food sensor temperature.
-  - the food sensor temperature.

1. Set a heating function and the oven temperature.
2. Insert the tip of the food sensor into the centre of the thickest part of the meat or fish. For casseroles, place the tip of the food sensor exactly in the centre, stabilized in a solid ingredient. Make sure the tip does not touch the bottom of the baking dish.

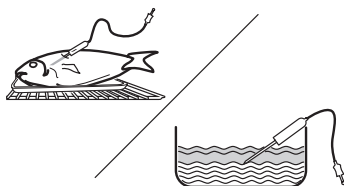

3. Plug food sensor into the socket located inside the appliance. Refer to Product description. The display shows the current temperature of food sensor.
4. Turn the control knob to set the temperature. Press **OK**.
5. When food reaches the set temperature, the signal sounds. Press any symbol to stop the signal. Check if the food is ready. Extend the cooking time, if needed.

6. Turn off the appliance.
7. Remove food sensor plug from the socket and remove the dish from the appliance.

5.10 Trivet and Grill- / Roasting pan

⚠ WARNING!

Be careful when you remove the accessories from a hot appliance. There is a risk of burns.

You can use the trivet to roast larger pieces of meat or poultry on one shelf position.

1. Put the trivet into the deep pan so that the supports of the wire shelf point up.

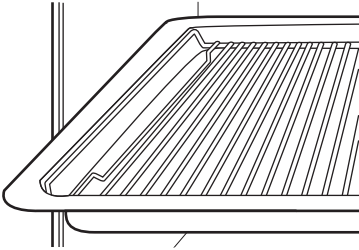

2. Put the deep pan into the appliance on the necessary shelf position.

You can use the trivet to grill flat dishes in large quantities and to toast.

1. Put the trivet into the deep pan so that the supports of the wire shelf point down.

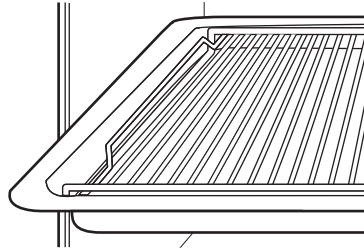

2. Put the deep pan into the appliance on the necessary shelf position.





6. HINTS AND TIPS

6.1 Cooking recommendations

The temperature and cooking times in the tables are for guidance only. They depend on the recipes, quality and quantity of the ingredients used. If you cannot find the settings for a specific recipe, look for a similar one.



Count the shelf positions from the bottom of the oven floor.

Symbols used in the tables:

	Food type
	Heating function
°C	Temperature
	Shelf position
	Cooking time (min)
	Additional information



6.2 Moist Fan Baking













For the best results follow suggestions listed in the table below.









	°C		
Pasta gratin	200 - 220	45 - 55	3
Potato gratin	180 - 200	70 - 85	3
Moussaka	170 - 190	70 - 95	3
Lasagne	180 - 200	75 - 90	3
Cannelloni	180 - 200	70 - 85	3
Bread pudding	190 - 200	55 - 70	3
Rice pudding	170 - 190	45 - 60	3
Apple cake, made of sponge cake mixture (round cake tin)	160 - 170	70 - 80	3
White bread	190 - 200	55 - 70	3

6.3 Information for test institutes

Tests according to EN 60350-1, IEC 60350-1.

	°C			
Small cakes, 20 per tray				
	150	20 - 30	3	1) 2)

	°C			
	170	20 - 30	3	1) 2)
	150	25 - 35	2 and 4	1)2)
Fatless sponge cake				
	160	45 - 60	2	3)2)
	160	45 - 60	2	3)2)
	160	45 - 55	2 and 4	4)
Apple pie				
	160	55 - 65	2	3)5)
	180	55 - 65	1	3)5)
	160	55 - 65	2 and 4	3)
Shortbread				

	°C			
	140	25 - 35	2	1)
	140	25 - 35	2	1)
	140	25 - 45	2 and 4	1)
Toast				
	max.	1 - 2	5	3)6)

- 1) Use baking tray with the slope towards the door.
- 2) Preheat the empty appliance.
- 3) Use Wire shelf.
- 4) Use wire shelf and baking tray below. Place baking tray with the slope towards the door.
- 5) 2 tins placed diagonally (Ø 20 cm). The right one to be positioned more in the front than the left one.
- 6) According to: IEC 60350-1:2016 and IEC 60350-1:2023.

7. CARE AND CLEANING

7.1 Notes on cleaning

- Use a cleaning solution for metal surfaces.
- Use the liquid descaler recommended by the manufacturer to remove limestone residue.
- Do not store food in the appliance for longer than 20 minutes.
- Do not clean the accessories in a dishwasher.

7.2 Removing the shelf supports

1. Make sure the appliance is cold.
2. Pull the front of the shelf support away from the side wall.
3. Pull the rear end of the shelf support away from the side wall and remove it.
4. Put the shelf supports back to the initial position. Repeat the steps in the reverse order.



If the telescopic runners are supplied, their retaining pins must point to the front.

7.3 Pyrolytic Cleaning

This programme burns off residual dirt in the appliance. Use it whenever your appliance needs a deep cleaning.

If there are other appliances installed in the same cabinet, do not use them at the same

time as this function. It can cause damage to the oven.

1. Make sure that the appliance is cold.
2. Remove all accessories and removable shelf supports.
3. Clean the oven interior and the inner door glass with warm water, a soft cloth and a mild detergent.
4. Turn the knob for the heating functions to  to enter Menu.
5. Turn the control knob to select  and press OK.

Cleaning programme	Duration
C1 - Light cleaning	1 h
C2 - Normal cleaning	1 h 30 min
C3 - Thorough cleaning	3 h

6. Turn the control knob to select the cleaning programme and press OK.
7. Press OK to start cleaning.

When the cleaning starts, the appliance door is locked and the lamp is off. Do not start the

function if you did not fully close the oven door. Until the door unlocks the display shows .

- After cleaning, turn the knob for the heating functions to the off position.
- Wait until the appliance is cold and the door unlocks. Clean the oven interior with soft cloth and water.

7.4 Cleaning Reminder

When  flashes on the display after cooking session, the appliance reminds you to clean it with pyrolytic cleaning. You can turn off the reminder in the submenu: Settings. Refer to Daily use, Changing: Settings.

7.5 Removing and installing door

- Make sure the appliance is cold.
- Fully open the door.
- Press the clamping levers **A** on the two door hinges.

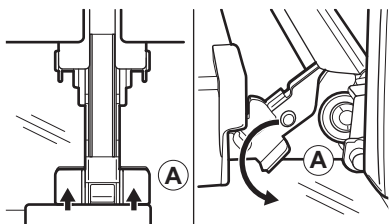

- Close the door partially until it stops, then lift it off the hinges. Be careful, the door is heavy.
- Place the door on a soft cloth on a stable surface.

- Hold the door trim **B** on the top edge of the door at the two sides and push inwards to release the clip seal.

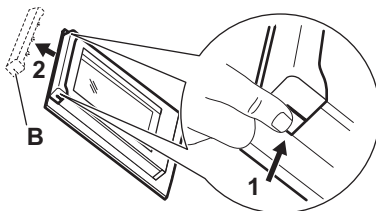

- Pull the door trim to the front to remove it.
- Lift each glass panel by its top edge and remove it from the guide. Carefully handle the glass, especially around the edges of the front panel. The glass can break.
- Clean the glass panel with water and soap. Dry the glass panel carefully. Do not clean the glass panels in the dishwasher.

After cleaning, do the above steps in the opposite sequence.

7.6 Replacing the lamp

Disconnect the appliance from the mains and wait until it is cold.

Replace the lamp with a suitable 300 °C heat-resistant lamp.

Top lamp

- Turn the glass cover to remove it.
- Clean the glass cover.
- Replace the lamp.
- Install the glass cover.

8. TROUBLESHOOTING

If you cannot find a solution to the problem yourself, contact your dealer or an Authorised Service Centre. Service details are on the rating plate, located on the front frame. It is visible when you open the door. Do not remove the rating plate.

If the display shows an error code that is not in this table, turn the house fuse off and on to restart the appliance. If the error code recurs contact an Authorised Service Centre.

You cannot activate or operate the appliance. - The appliance is not connected to an electrical supply or it is connected incorrectly.

The appliance does not heat up.

- The door is not closed correctly.
- Lock is activated.
- Automatic switch-off is activated.

The lamp does not work. - The lamp is burnt out. Replace the lamp.

The lamp is turned off. - Moist Fan Baking - is activated.

The Food Sensor does not operate. - The plug of the Food Sensor is not fully inserted into the socket.

The display shows "00:00". - There was a power cut. Set the time of day.

Err C2 - Fully plug Food Sensor into the socket.

Err C3 - Close the door. Turn the appliance off and on. Check if the door lock is not broken.

Err F102 - Close the door. Check if the door lock is not broken.

9. ENERGY EFFICIENCY

9.1 Product Information Sheet and Product Information according to (EU) No 65/2014 and (EU) No 66/2014

Supplier's name	AEG	
Model identification	OS6PB50AK 944035175	OS6PB50AM 944035174
Energy Efficiency Index	81.2	
Energy efficiency class	A+	
Energy consumption with a standard load, conventional mode	1.09 kWh/cycle	
Energy consumption with a standard load, fan-forced mode	0.69 kWh/cycle	
Number of cavities	1	
Heat source	Electricity	
Volume	71 l	
Type of oven	Built-In Oven	
Mass	OS6PB50AK	35.0 kg
	OS6PB50AM	35.0 kg

Appliance tested according to: EN IEC 60350-1.

9.2 Information requirements according to (EU) No 2023/826

Power consumption in standby	0.8 W
Maximum time needed for the equipment to automatically reach the applicable low power mode	20 min

Appliance tested according to: EN 50564.

9.3 Energy saving tips

- Keep the door closed during cooking and avoid opening it often.

- Keep the door gasket clean and make sure it is well fixed in its position.
- Use metal or dark, non-reflective cookware.
- Skip preheating unless needed.
- Minimize breaks between baking multiple dishes.
- When possible, use the cooking functions with fan to save energy (selected models only).
- Use residual heat to keep food warm. Reduce the appliance temperature to minimum 3 - 10 min before the end of cooking.
- Turn off the lamp during cooking unless needed.
- Moist Fan Baking (selected models only) - this function was used to comply with the energy efficiency class and ecodesign requirements (according to EU 65/2014 and EU 66/2014). Tests according to: IEC/EN 60350-1. The oven door should be closed during cooking so that the function is not interrupted and the oven operates with the highest energy efficiency possible. When you use this function the lamp automatically turns off. In some models it takes 30 sec.
- Automatic switch-off - for safety reasons, if the heating function is active and no settings are changed, the appliance will turn off automatically after a certain period of time. If you intend to run a heating function for a duration exceeding the automatic switch-off time, set the cooking time.
 - 12.5 h: 30-115 °C
 - 8.5 h: 120-195 °C
 - 5.5 h: 200-245 °C
 - 3 h: 250-maximum °C

10. ENVIRONMENTAL CONCERNS

Recycle materials with the symbol . Put the packaging in relevant containers to recycle it. Help protect the environment and human health by recycling waste of electrical and electronic appliances. Do not dispose of ap-

pliances marked with the symbol  with the household waste. Return the product to your local recycling facility or contact your municipal office.

