

PX375MB

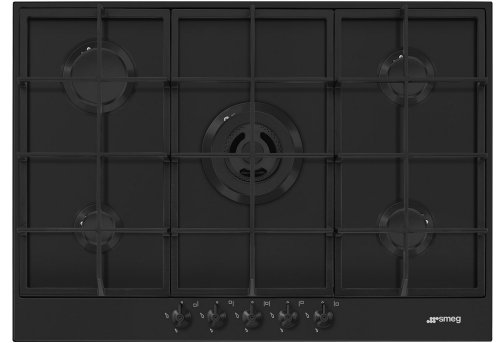

Product Family	Hob
Built-in	Traditional
Dimensions	70/75 cm
Power supply	Gas
Type	Gas
EAN code	8017709321628



Aesthetics



Aesthetics	Classic
Colour	Matte Black
Finishing	Matte black
Material	Enamelled
Series	New
Pan stands	Cast iron
Burners	Smeg Contemporary
Burner Material	Aluminium
Burner Coating	Black Ceram
Type of control setting	Control knobs
Control knobs position	Front
No. of controls	5
Controls colour	Matt Black
Serigraphy colour	Silver

Program / Functions

No. of gas cook zones	5
Total no. of cook zones	5

Options



Standard cut out	478-482x555-560 mm
-------------------------	--------------------

Technical Features

UR

Front left - Gas - AUX - 1.10 kW
 Rear left - Gas - Rapid - 2.60 kW
 Central - Gas - UR - 4.00 kW
 Rear right - Gas - Semi Rapid - 1.80 kW
 Front right - Gas - Semi Rapid - 1.80 kW

Gas safety valves Yes **Automatic Ignition** Yes

Electrical Connection

Nominal power (W)	1 W	Frequency (Hz)	50/60 Hz
Voltage (V)	220-240 V	Power supply cable length	120 cm
Type of electric cable	Single phase		

Gas Connection

Gas Type	G20 Natural gas	Other gas connections provided	Conical
Gas connection	Cilindrica	Gas connection rating (W)	11300 W
Other gas nozzles included	G30 GPL Liquid gas		

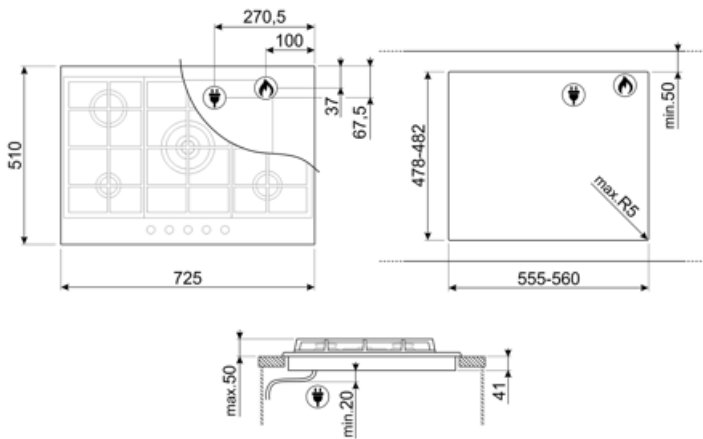

Not included accessories



GRW
Wok support







TPK
Stainless steel grill plate to cook
Teppanyaki dishes



WOKGHU
Cast-Iron WOK Support

Symbols glossary

- | | | | |
|--|--|---|---|
|  | Standard installation: Traditional installation in tabletop, suitable for any kitchen sets |  | Heavy duty cast iron pan stands: for maximum stability and strength. |
|  | CUT_OUT_STANDARD_72dpi |  | Ultra rapid burners: Powerful ultra rapid burners offer up to 5kw of power. |
|  | Knobs control | | |