

We advise you to read this manual carefully, which contains all the instructions for maintaining the appliance's aesthetic and functional qualities. For further information on the product: [www.smeg.com](http://www.smeg.com)

## PRECAUTIONS

---

### General safety instructions

#### Risk of personal injury

- **ATTENTION:** during use, the appliance and its accessible parts become very hot. Children must be kept away from the appliance.
- **ATTENTION:** during use, the appliance and its accessible parts become very hot. Never touch the heating elements during use.
- Protect your hands by wearing oven gloves when moving food inside the oven.
- Never try to put out a fire or flames with water: turn off the appliance and smother the flames with a fire blanket or other appropriate cover.
- This appliance may be used by children aged at least 8 and by people of reduced physical, sensory or mental capacity, or lacking in experience in the use of electrical appliances, provided that they are supervised or instructed by adults who are responsible for their safety.
- Children must not play with the appliance.
- Keep children under the age of 8 at a safe distance unless they are constantly supervised.
- Keep children under the age of 8 away from the appliance when it is in use.
- Cleaning and maintenance must not be carried out by unsupervised children.
- The cooking process must always be monitored. A short cooking process must be continuously surveyed.
- Never leave the appliance unattended during cooking operations where fats or oils could be released, as these could then heat up and catch fire. Be very careful.
- Do not pour water directly onto very hot trays.
- Keep the oven door closed during cooking.
- If you need to move food or at the end of cooking, open the door 5 cm for a few seconds, let the steam come out, then open it fully.
- Do not insert pointed metal objects (cutlery or utensils) into the slots in the appliance.
- Switch off the appliance

immediately after use.

- DO NOT USE OR STORE FLAMMABLE MATERIALS NEAR THE APPLIANCE.
- DO NOT USE AEROSOLS IN THE VICINITY OF THIS APPLIANCE WHILST IT IS IN USE.
- DO NOT MODIFY THIS APPLIANCE.
- Installation and servicing should be carried out by qualified personnel in accordance with current standards.
- Do not try to repair the appliance yourself or without the assistance of a qualified technician.
- Do not pull the cable to unplug the appliance.

#### Risk of damaging the appliance

- Do not use abrasive or corrosive detergents (e.g. scouring powders, stain removers and metallic sponges), rough or abrasive materials or sharp metal scrapers on glass parts as this could cause scratch the surface and break the glass. Use wooden or plastic utensils.
- Do not sit on the appliance.
- Do not use cleaning products containing chlorine, ammonia or bleach on parts made of steel or that have metallic surface finishes (e.g. anodizing, nickel- or

chromium-plating).

- Racks and trays should be inserted as far as they will go into the side guides. The mechanical safety locks that prevent them from being removed must face downwards and towards the back of the oven cavity.

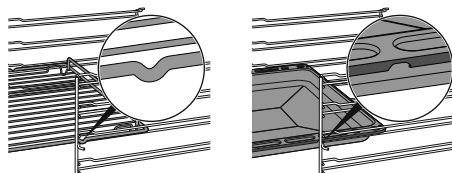

- Do not use steam jets to clean the appliance.
- Do not spray any spray product near the appliance.
- Do not obstruct ventilation openings and heat dispersal slots.
- Fire hazard: never leave objects in the oven cavity.
- DO NOT FOR ANY REASON USE THE APPLIANCE AS A SPACE HEATER.
- Do not use plastic cookware or containers when cooking food.
- Do not place sealed tins or containers in the oven cavity.
- Remove all trays and racks which are not required during cooking.
- Do not cover the bottom of the oven cavity with aluminium or tin foil sheets.
- Do not place pans or trays directly on the bottom of the oven cavity.

- If necessary, you can use the tray rack (supplied or sold separately, depending on the model) by placing it on the bottom as a support for cooking.
- If you wish to use greaseproof paper, place it so that it will not interfere with the hot air circulation inside the oven cavity.
- Do not use the open door to rest pans or trays on the internal glass pane.
- Never use the oven door to lever the appliance into place when fitting.
- Avoid exerting too much pressure on the door when open.
- Do not use the handle to lift or move this appliance.

### For pyrolytic appliances

- When the pyrolytic function is in use, the surfaces could reach temperatures that are higher than usual. Keep children at a safe distance.
- Before starting the pyrolytic cycle, remove any food residues or large spills from previous cooking operations from the inside of the oven.
- Before starting the pyrolytic cycle, remove all accessories from the oven cavity.
- Before starting the pyrolytic cycle, switch off the burners or electric hot plates of the

hob installed above the oven.

### Installation and maintenance

- **THIS APPLIANCE MUST NOT BE INSTALLED IN A BOAT OR CARAVAN.**
- The appliance must not be installed on a pedestal.
- Position the appliance into the cabinet cut-out with the help of a second person.
- To prevent any possible overheating, the appliance should not be installed behind a decoration door or a panel.
- Installation and servicing should be carried out by qualified personnel in accordance with current standards.
- Have the electrical connection performed by authorised technical personnel.
- The appliance must be connected to earth in compliance with electrical system safety standards.
- Use cables withstanding a temperature of at least 90 °C.
- The tightening torque of the screws of the terminal supply wires must be 1.5 - 2 Nm.
- If the power cable becomes damaged, contact technical support immediately to arrange for it to be replaced in order to avoid possible

- hazards.
- **WARNING:** while positioning the appliance, make sure that the power supply cable is not caught or damaged.
  - Always use any necessary/required personal protective equipment (PPE) before performing any work on the appliance (installation, maintenance, positioning or movement).
  - Before performing any work on the appliance, switch off the power supply.
  - Allow the appliance to be disconnected after installation, via an accessible plug or a switch in the case of a fixed connection.
  - Fit the power line with an all-pole circuit breaker with a contact separation distance sufficient to provide complete disconnection in category III overvoltage conditions, pursuant to installation regulations.
  - **WARNING:** Make sure that the appliance has been switched off and disconnected from the mains power supply or that the mains power has been switched off before replacing the interior lighting bulbs.
  - The bulbs used in this appliance are specific for

household appliances; do not use them for home lighting.

- This appliance can be used up to a maximum altitude of 2,000 metres above sea level.

### For this appliance

- Do not rest any weight or sit on the open door of the appliance.
- Take care that no objects are stuck in the doors.
- Do not install/use the appliance outdoors.
- Only use the temperature probe provided or recommended by the manufacturer (on some models only).

### Appliance purpose

This appliance is intended for cooking food in the home environment. Every other use is considered improper. It must also not be used:

- In kitchen areas provided for employees in shops, offices and other work environments.
- in farms/farmhouses.
- By guests in hotels, motels and other types of residential environments.
- In bed and breakfasts.



This appliance may only be installed and used indoors.

### This user manual

- This user manual is an integral part of

the appliance and must therefore be kept in its entirety and within the user's reach for the whole working life of the appliance.

- Read this user manual carefully before using the appliance.
- The explanations in this manual include images, which describe all that regularly appears on the display. However, it should be kept in mind that the appliance may be equipped with an updated version of the system, and as such, all that appears on the display may differ from those in the manual.

## Manufacturer's liability

The manufacturer declines all liability for damage to persons or property caused by:

- use of the appliance other than that specified;
- failure to comply with the instructions in the user manual;
- tampering with any part of the appliance;
- use of non-original spare parts.

## Identification plate

The identification plate bears the technical data, serial number and brand name of the appliance. Do not remove the identification plate for any reason.

## Disposal



This appliance conforms to the WEEE European directive (2012/19/EU) and must be disposed of separately from other waste at the end of its service life.

The appliance does not contain substances in quantities sufficient to be considered hazardous to health and the environment, in accordance with current European directives.



### Power voltage Danger of electrocution

- Disconnect the mains power supply.
- Unplug the appliance.

To dispose of the appliance:

- Cut the power cable and remove it.
- Deliver the appliance to the appropriate recycling centre for electrical and electronic equipment waste, or return it to the retailer when purchasing an equivalent product, on a one for one basis.

Our appliances are packaged in non-polluting and recyclable materials.

- Deliver the packing materials to the appropriate recycling centre.



### Plastic packaging Danger of suffocation

- Do not leave the packaging or any part of it unattended.
- Do not let children play with the plastic bags.

## Information for European Control Bodies

### Fan forced mode

the ECO function used to define the energy efficiency class complies with the specifications of European standard EN 60350-1.

### Energy efficiency technical data

Information in accordance with the European energy labelling and ecodesign regulations is contained in a separate document accompanying the product instructions.

These data are present in the "Product information sheet" that can be downloaded from the website at the page dedicated to the product in question.

### To save energy

- Only preheat the appliance if the recipe requires you to do so.
- Unless otherwise indicated on the package, defrost frozen foods before placing them in the oven.
- When cooking several types of food it is recommended to cook the foods one after the other to make the best use of the already hot oven.
- Use dark metal moulds: They help to absorb the heat better.
- Remove all trays and racks which are not required during cooking.
- Stop cooking a few minutes before the time normally used. Cooking will continue for the remaining minutes with the heat which has accumulated inside the oven.
- Reduce any opening of the door to a minimum to avoid heat dispersal.
- Keep the inside of the oven clean at all times.

## Information on power consumption in off/stand-by mode

Technical data on the appliance's power

consumption in off/stand-by mode can be found at [www.smeg.com](http://www.smeg.com) under the page corresponding to the product in question.

## Light sources

- This appliance contains user-replaceable light sources.

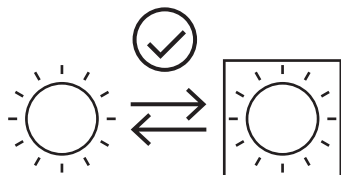

- The light sources contained in the appliance are declared suitable for

operation at ambient temperature  $\geq 300^{\circ}\text{C}$  and intended for use in high temperature applications such as ovens.

- This appliance contains light sources of efficiency class "G".

## How to read the user manual

This user manual uses the following reading conventions:



Warning/Caution



Information/Advice

# DESCRIPTION

## General description

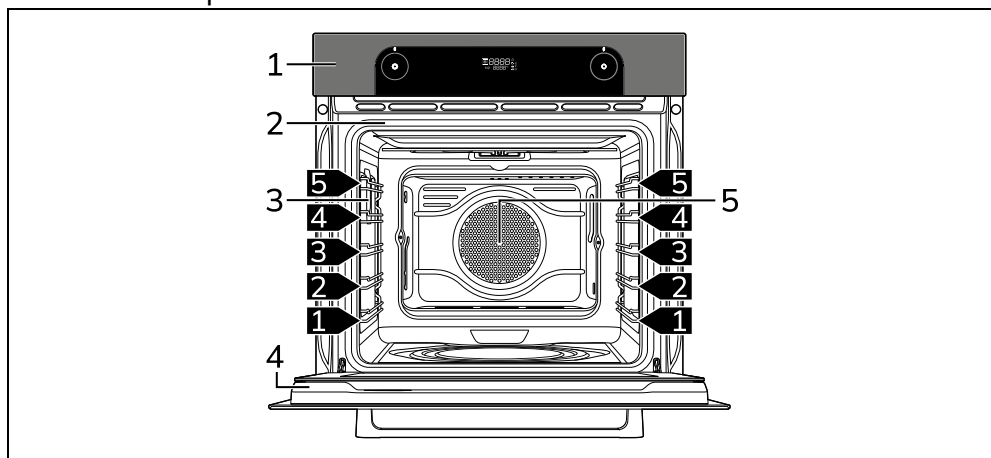

- Control panel
- Gasket
- Light
- Door

- Fan
- 1,2,3 Frame shelf

## Control panel

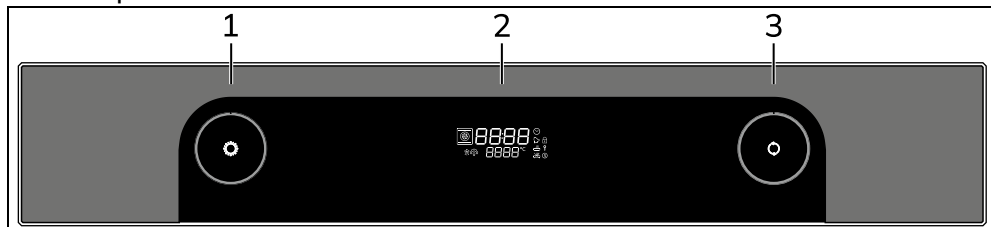

### 1 Function knob

This knob can be used to:

- turn the appliance on and off;

- select a function.



Turn the Function knob to the position 0 to immediately complete any cooking operation.

## 2 Digital programmer

Displays the current time, the minute minder, the function, the power and the selected cooking temperature and any time set.

## 3 Temperature knob

This knob can be used to set:

- the cooking temperature;
- the duration of a function;
- programmed cooking cycles;
- the current time.

## Other parts

### Shelves

The appliance features shelves to position trays and racks at different heights. The insertion heights are indicated from the bottom upwards.

### Cooling fan

The fan cools the appliance and comes into operation during cooking.

The fan causes a steady outflow of air from above the door which may continue for a short period of time even after the appliance has been turned off.

### Oven cavity lighting

- The lighting of the oven cavity is activated when any cooking function is selected, excluding the **ECO** function.
- The interior lighting remains switched off during the execution of the **DEFR - PROU - SABB** special functions and the **CLEAR - PYRO** cleaning functions (depending on the models).
- When the door is opened, excluding the **SABB** function, the lighting in the oven cavity is switched on. It switches off immediately when the door is closed.
- When the door is open, it is not possible to turn off the interior lighting.

## Accessories



Not all accessories are available on some models.



The accessories intended to come into contact with food are made of materials that comply with the provisions of current legislation.



Original supplied and optional accessories can be requested to Authorised Assistance Centres. Use only original accessories supplied by the manufacturer.

### Rack

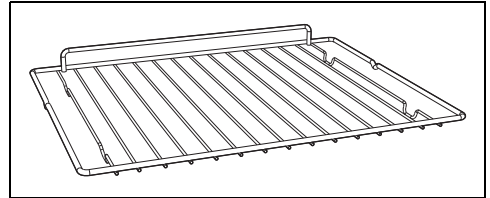

Useful for supporting containers with food during cooking.

### Tray rack

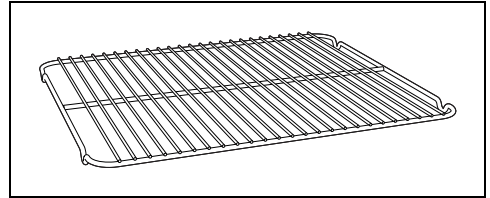

To be placed over the top of the tray; for cooking foods which may drip.

### Deep tray

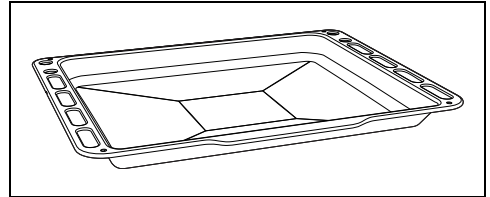

Useful for collecting fat from foods placed on the rack above and for cooking pies, pizzas, baked desserts, biscuits, etc.

## AIRFRY (oil-free frying rack)

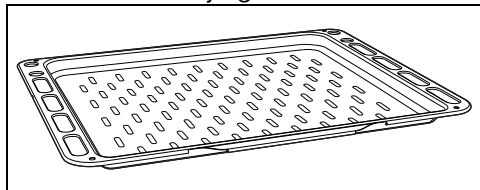

Recommended accessory for air frying

breaded, pre-cooked and/or frozen foods (French fries, potato or meat croquettes, mozzarella, etc.).

## USE

### Preliminary operations



See General safety instructions.

- Remove any protective film from the outside or inside of the appliance, including accessories.
- Remove any labels (apart from the technical data plate) from the accessories and shelves.
- Remove and wash all the appliance accessories (see chapter "CLEANING AND MAINTENANCE").

### First heating

1. Set a cooking time of at least one hour (see paragraph "Using the oven").
2. Heat the empty oven compartment at the maximum temperature to burn off any residues left by the manufacturing process.

When heating the appliance

- air the room;
- don't stay.

### Using the accessories

#### Racks and trays

Racks and trays have to be inserted into the side guides until they come to a complete stop.

- The mechanical safety locks that prevent the rack from being removed accidentally must face downwards and

towards the back of the oven cavity.

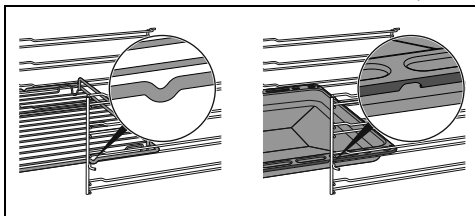

Gently insert racks and trays into the oven until they come to a stop.



Clean the trays before using them for the first time to remove any residues left by the manufacturing process.

#### Tray rack

The tray rack has to be inserted into the tray. In this way fat can be collected separately from the food which is being cooked.

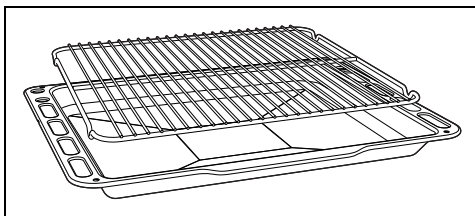

### Using the oven











See General safety instructions.

## Digital programmer



The parameters and values for the currently selected function will be indicated on the display. To use it, just turn the function and temperature knobs to select the indicated values.

-  Clock indicator light
-  Minute minder indicator light
-  Cooking indicator light
-  Programmed cooking indicator light
-  Door lock indicator light (pyrolytic models only)
-  Control lock indicator light
-  Showroom indicator light
-  Defrost indicator light
-  Temperature indicator light

### First use

 If the time is not set, the oven will not switch on.

On the first use, or after a long power failure, the message  will flash on the appliance's display. To be able to start any cooking function, the current time must be set.

1. Turn the temperature knob to select the current time.
2. Press the temperature knob to set the current time and go to the selection of minutes.
3. Turn the temperature knob to select the minutes of the current time.
4. Press the temperature knob to finish adjustment.

 It may become necessary to change the current time, for example for daylight saving time.

 When the current time is visible, after 2 minutes from the last knob operation it is displayed with low brightness.

## Using the oven

 See General safety instructions.

### Traditional cooking

 Cooking functions can be interrupted at any time by turning the function knob to the 0 position.

1. Turn the function knob to the right or to the left to select the wished function (for example "FAN-ASSISTED" ).
2. Turn the temperature knob to the right or to the left to select the wished temperature (for example "200°C").

Wait 3 seconds (or press the temperature knob before waiting 3 seconds) to start cooking.

After having started cooking, press the temperature knob to enter any setting of cooking duration, cooking end time...





 When the door is opened, the function in progress is interrupted. The function resumes automatically when the door is closed.

### Preheating stage

Cooking itself is preceded by a preheating stage, which allows the appliance to heat to the cooking temperature more quickly.

The indicator light  flashes to indicate that this stage is in progress.

 You can skip the preheating phase by pressing the temperature knob for a few seconds.

At the end of preheating the indicator light  will stay on permanently, the symbol of the oven cavity  flashes and a buzzer sounds.

1. Open the door
2. Place the dish with the food to be cooked into the oven cavity.

3. Close the door.

or

If the dish with the food is already inside the oven cavity, press the temperature knob to start cooking.

### Timed cooking



Timed cooking is the function which allows a cooking operation to be started and then ended after a specific length of time set by the user.



Activation of timed cooking cancels any minute minder timer which may previously have been set.

1. After selecting a cooking function and temperature, press the temperature knob.



The display shows **00:00** flashing.



2. Within 3 seconds turn the temperature knob to change the temperature or
3. Press the temperature knob to set the cooking time (from 1 minute to 13 hours) (e.g. "25 minutes").



4. Wait 3 seconds.

The indicator light  stops flashing, the symbol  lights up and timed cooking begins.

At the end of the cooking time **STOP** flashes on the display and a buzzer will sound that can be deactivated by opening the door and/or pressing/turning any of the

two knobs.



To select a further timed cooking, turn again the temperature knob.

### To delete a timed cooking

1. Press the temperature knob.

The indicator light  flashes on the display.

2. Within 3 seconds, turn the temperature knob counter-clockwise until the cooking time is reset.
3. Wait 3 seconds or press the temperature knob to exit the timed cooking function and return to the current time display.

### Programmed cooking



Programmed cooking is the function which allows a cooking operation to be started at a set time and then ended after a specific length of time set by the user.



For safety reasons, it is not possible to set the end of cooking time by itself without setting the cooking duration.

1. After selecting a cooking function and temperature, press the temperature knob.

The display shows **00:00** flashing.



2. Within 3 seconds turn the temperature knob to set the cooking time (from 1 minute to 13 hours) (e.g. "25 minutes").



3. Press the temperature knob. The display shows the suggested flashing time for immediate cooking.

 In case of confirmation without modification, cooking starts immediately. If time is added to the suggested time, cooking stops.

4. Turn the temperature knob within 3 seconds to set the end of cooking time (e.g. "13:15").



5. Wait 3 seconds.

The indicator light  and the appliance waits for the set start time.



 The minutes required for pre-heating are already included in the end-of-cooking time.

At the end of the cooking time **STOP** flashes on the display and a buzzer will sound that can be deactivated by opening the door and/or pressing/turning any of the two knobs.



## How to cancel programmed cooking

1. Press the temperature knob.

The indicator light  flashes on the display.

2. Within 3 seconds, turn the temperature knob clockwise or counter-clockwise to set a new timed cooking.

The set cooking has now been deleted.



Cooking functions can be interrupted at any time by turning the function knob to the 0 position.

## Minute minder timer during a cooking process



The minute minder timer does not stop the cooking operation but rather informs the user when the set time has run out.



It is not possible to set a minute minder during a cooking if a timed cooking has already been set.

1. After selecting a cooking function and temperature, press the temperature knob two times.

The display shows **00:00** and the indicator light  flashes.



You can also set a minute minder timer also when cooking is in progress.

2. Within 3 seconds turn the temperature knob to set the duration of the minute minder (from 1 minute to 13 hours).
3. Wait 3 seconds.

The indicator light  stops flashing and the minute minder starts.

4. Wait for the buzzer to indicate that the time has finished.

The digits **00:00** and the indicator light  flash.

5. Turn the temperature knob to select additional minute minders or press the temperature knob to deactivate the

buzzer and exit the minute minder during cooking.

After a few seconds, the display shows the current time and the cooking in progress continues.

#### To delete a minute minder timer during cooking

1. During cooking, press the temperature knob twice.

The indicator light  flashes on the display.

2. Within 3 seconds, turn the temperature knob counter-clockwise until the minute minder value is reset.
3. Wait 3 seconds to exit the minute minder function during cooking.

#### List of traditional cooking functions



Not all functions are available on some models.

#### STATIC



Traditional cooking, ideal for preparing a single dish. For example cooking roast meats, fatty meats, bread, pies.

#### FAN ASSISTED



Intense and uniform cooking. Ideal for biscuits, cakes and cooking on more than one level.

#### CIRCULAIRE



The heat is distributed quickly and uniformly. Suitable for all dishes, ideal for cooking on multiple levels without mixing smells or flavours.

#### TURBO



Allows quick cooking on multiple shelves without mixing the aromas. Perfect for large volumes that call for intense cooking.

#### GRILL



Produces excellent grilling and gratinating results. When used at the end of cooking, gives a uniform browning to dishes.

#### FAN WITH GRILL



Allows optimal grilling, even for thick slices of meat. Perfect for larger cuts of meat.

#### BOTTOM HEAT



The heat comes from the bottom of the cavity. Perfect for cakes, pies, tarts and pizzas.

#### THERMALLY-VENTILATED BASE



Allows you to quickly finish cooking food already cooked on the surface but not internally. Perfect for any quiches and any type of food.

#### ECO



This function is particularly suitable for cooking on a single shelf with low energy consumption.

It is recommended for all types of food except those that may produce a large amount of moisture (e.g. vegetables).

To obtain maximum energy savings and reduce cooking times, it is recommended to place food in the oven without preheating.



When using the ECO function, avoid opening the door during cooking.



Cooking (and preheating) times are longer with the ECO function and may depend on the amount of food in the oven.



The ECO function is a delicate cooking function and is recommended for cooking that does not require temperatures higher than 210°C. It is recommended that you select a different function for cooking at higher temperatures.

#### Cooking advice

##### General advice

- Use a fan assisted function to achieve consistent cooking at several levels.
- It is not possible to shorten cooking times by increasing the temperature (the food could be overcooked on the outside and undercooked on the inside).

##### Advice for cooking meat

- Cooking times vary according to the thickness and quality of the food and to consumer taste.
- Use a meat thermometer when roasting meat, or simply press on the roast with a spoon. If it is hard, it is ready; if not, it needs another few minutes cooking.

### **Advice for cooking with the Grill and the Fan with grill**

- Meat can be grilled even when it is put into the cold oven or into the preheated oven if you wish to change the effect of the cooking.
- When using the fan-assisted with grill function, we recommend that you preheat the oven before grilling.
- We recommend placing the food at the centre of the rack.
- With the Grill function, we recommend that you set the temperature to the maximum value to optimise cooking.

### **Advice for cooking desserts/pastries and biscuits**

- Use dark metal moulds: They help to absorb the heat better.
- The temperature and the cooking time depend on the quality and consistency of the dough.
- To check whether the dessert is cooked right through: At the end of the cooking time, put a toothpick into the highest point of the dessert. If the dough does not stick to the toothpick, the dessert is cooked.
- If the dessert collapses when it comes out of the oven, on the next occasion reduce the set temperature by about 10°C, selecting a longer cooking time if necessary.

### **Advice for defrosting and proving**

- Place frozen foods without their packaging in a lidless container on the first shelf of the oven.
- Avoid overlapping the food.
- To defrost meat, use the rack placed on the second level and a tray on the first level. In this way, the liquid from the defrosting food drains away from the food.
- The most delicate parts can be covered with aluminium foil.
- For successful proving, a container of water should be placed in the bottom of the oven.

### **To save energy**

- Stop cooking a few minutes before the time normally used. Cooking will continue for the remaining minutes with the heat which has accumulated inside the oven.
- Reduce any opening of the door to a minimum to avoid heat dispersal.
- Keep the inside of the appliance clean at all times.

## Mini guide to accessories

We recommend the use of the grill as a support surface for baking moulds/casseroles. In the absence of the baking tray grill, the grill can be used as a base for grilling with the deep baking tray placed on a shelf below to collect the juices.

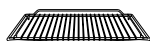

Rack

For multilevel baking, place two grills leaving one free shelf between them. Use the

THERMALLY-VENTILATED  and/or THERMALLY-VENTILATED BASE function



We recommend the use of the deep baking tray for cooking on one level only.

Place the deep baking tray on the centre shelf when using the fan-assisted functions.



Deep tray

When using the STATIC function,  place the deep baking tray on the required shelf.

Place the baking tray on the last shelf with the baking tray grill to cook in GRILL mode



Tray rack

We recommend using the baking tray grill as a base to collect the juices from the grills.

## Traditional cooking information table

Food	Weight (kg)	Function	Shelf	Temperature (°C)	Time (minutes)	
Lasagne	3 - 4	Static	1	220 - 230	45 - 50	
Pasta bake	3 - 4	Static	1	220 - 230	45 - 50	
Veal roast	2	Turbo/Fan-assisted	2	180 - 190	90 - 100	
Pork loin	2	Turbo/Fan-assisted	2	180 - 190	70 - 80	
Sausages	1.5	Fan-assisted grill	4	250	15	
Roast beef	1	Turbo/Fan-assisted	2	200	40 - 45	
Roast rabbit	1.5	Fan-assisted/Fan-Heated	2	180 - 190	70 - 80	
Turkey breast	3	Turbo/Fan-assisted	2	180 - 190	110 - 120	
Roast pork neck	2 - 3	Turbo/Fan-assisted	2	180 - 190	170 - 180	
Roast chicken	1.2	Turbo/Fan-assisted	2	180 - 190	65 - 70	
					1 <sup>st</sup> sur- face	2 <sup>nd</sup> surface
Pork chops	1.5	Fan-assisted grill	4	250	15	5
Spare ribs	1.5	Fan-assisted grill	4	250	10	10
Bacon	0.7	Grill	5	250	7	8
Pork fillet	1.5	Fan-assisted grill	4	250	10	5
Beef fillet	1	Grill	5	250	10	7
Salmon trout	1.2	Turbo/Fan-assisted	2	150 - 160	35 - 40	
Monkfish	1.5	Turbo/Fan-assisted	2	160	60 - 65	
Flounder	1.5	Turbo/Fan-assisted	2	160	45 - 50	

The times indicated in the table do not include preheating times and are provided only as a guide.

Food	Weight (kg)	Function	Shelf	Temperature (°C)	Time (minutes)
Pizza	1	Turbo/Fan-assisted	2	250	8 - 9
Bread	1	Fan-assisted/Fan-Heated	2	190 - 200	25 - 30
Focaccia	1	Turbo/Fan-assisted	2	180 - 190	20 - 25
Bundt cake	1	Fan-assisted/Fan-Heated	2	160	55 - 60
Tart	1	Fan-assisted/Fan-Heated	2	160	35 - 40
Ricotta cake	1	Fan-assisted/Fan-Heated	2	160 - 170	55 - 60
Jam tarts	1	Turbo/Fan-assisted	2	160	20 - 25
Chiffon cake	1.2	Fan-assisted/Fan-Heated	2	160	55 - 60
Profiteroles	1.2	Turbo/Fan-assisted	2	180	80 - 90
Sponge cake	1	Fan-assisted/Fan-Heated	2	150 - 160	55 - 60

The times indicated in the table do not include preheating times and are provided only as a guide.

## Information for Supervisory Bodies

### Fan forced mode

The ECO function used to establish the energy efficiency class is compliant with the specifications of European standard EN 60350-1.

See the “To save energy ” section in the INSTRUCTIONS chapter.

### Conventional heating mode

To use the STATIC mode, you have to skip the preheating stage (see the section “Preheating stage” in the USE chapter.

See the “To save energy ” section in the INSTRUCTIONS chapter.

### Minute minder



This function only operates the buzzer at the end of the countdown.

1. With the Function Knob at position 0, press the temperature knob.

The display shows  and the indicator light  flashes.

2. Within 3 seconds turn the temperature knob to set the duration of the minute minder (from 1 minute to 13 hours).
3. Wait 3 seconds.

The indicator light  stops flashing and the minute minder starts.



During the function, the display shifts to low brightness after 2 minutes from the last knob operation.

### End of the minute minder

1. Wait for the buzzer to indicate that the time has finished.

The digits  and the indicator light  flash.

2. Turn the temperature knob to select another minute minder.  
or
3. Press the temperature knob to deactivate the buzzer and exit the minute minder function.

After a few seconds, the display shows the current time.

### To delete a minute minder

1. Press the temperature knob.

The indicator light  flashes on the display.

2. Within 3 seconds, turn the temperature knob counter-clockwise until the minute minder value is reset.
3. Wait 3 seconds to exit the minute minder function.

## Special functions

1. Turn the function knob until the following text is displayed.



- Press the display knob to enter the special functions menu.

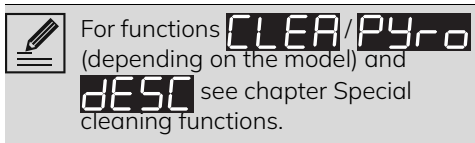

### Rapid defrost

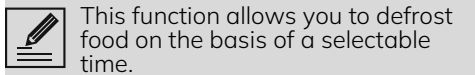

- Place the food to be defrosted inside the oven.
- After entering the special functions menu, turn the temperature knob until the defrost mode is selected.



- Press the temperature knob to confirm the function.

The display shows **00:00** and the indicator lights  and  flashes.



- Turn the temperature knob to set the defrosting time (from 1 minute to 13 hours) (e.g. "1:30").
- Wait 3 seconds or press the temperature knob to start the function.



At the end, the flashing wording **STOP** is displayed and a buzzer will sound that can be deactivated by opening the door and/or pressing/turning any of the two

knobs.

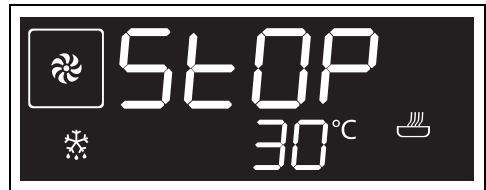

- Turn the function knob to position 0 to exit the function.

### Proving

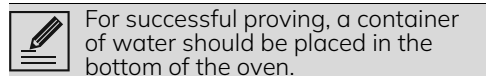

- Position the dough to prove on the second level.
- After entering the special functions menu, turn the temperature knob until Proving mode is selected.



- Press the temperature knob to confirm the function.
- Wait 3 seconds to start the function or press the temperature knob to enter any setting of function duration, function end time...



- At the end, turn the function knob to position 0 to exit the function.

### Sabbath mode

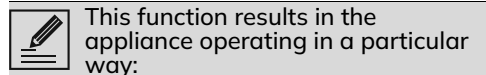

- Cooking can proceed for max. 73 hours, it is not possible to set any cooking duration.
- No pre-heating will be performed.
- The cooking temperature which can be selected varies between 60-150 °C.



This function results in the appliance operating in a particular way:

- Oven light disabled, any operation such as opening the door (where present) or manual activation with the knob will not activate the light.
- The internal fan remains turned off.
- Knob illumination and audible prompts remain disabled.



After activating the Sabbath mode the settings cannot be altered. Any action on the knobs will produce no effect; only the function knob remains active to allow you to return to 0 and switch the function off.

1. Place the dish into the oven cavity.
2. After entering the special functions menu, turn the temperature knob until the Sabbath mode is selected.



3. Press the temperature knob to confirm the function.

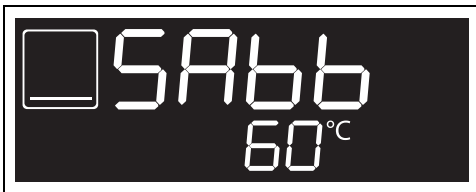

4. Turn the temperature knob to set required temperature (for example "90°C").
5. Press the temperature knob to start the function.

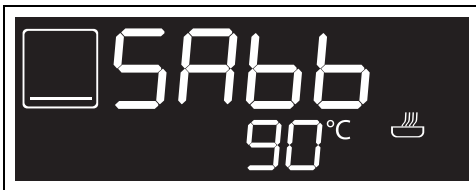

6. When finished, turn the function knob to position 0 to end cooking.

## PIZZA



Function designed for cooking pizza. Perfect not just for pizzas, but also for biscuits and cakes.

1. After entering the special functions menu, turn the temperature knob until the PIZZA function is selected.



2. Press the temperature knob to confirm the function.
3. Wait 3 seconds to start the function or press the temperature knob to enter any setting of temperature, cooking duration, cooking end time...



Cooking itself is preceded by a preheating stage, which allows the appliance to heat to the cooking temperature more quickly.

The indicator light  flashes to indicate that this stage is in progress.

When the preheating stage is over, the indicator light  will remain lit steadily and a buzzer sounds to indicate that the food can be placed inside the oven cavity.



In this function it is not possible to skip the preheating phase.

At the end of the cooking time **STOP** flashes on the display and a buzzer will sound that can be deactivated by opening the door and/or pressing/turning any of the two knobs.

To continue with the cooking of other pizzas, after deactivating the buzzer:

- press the function knob again to start the function
  - or
  - turn the function knob to set a new cooking time and restart the function.
4. Turn the function knob to position 0 to exit the function.

## Settings

1. Turn the function knob until the following text appears on the display.





2. Press the temperature knob to access the settings menu.

### Current time

After entering the settings menu, turn the temperature knob until the current time function is selected.



1. Press temperature knob to start adjusting the current time (e.g. "12:30").

During this procedure, the indicator light  and the symbols  flash.



2. Turn the temperature knob to select the current time.



3. Press the temperature knob to set the current time and go to the selection of minutes.



4. Turn the temperature knob to select the minutes of the current time.



5. Press the temperature knob to finish adjustment.



6. Turn the temperature knob to select a new setting or wait 10 seconds.

### Control lock (children safety)

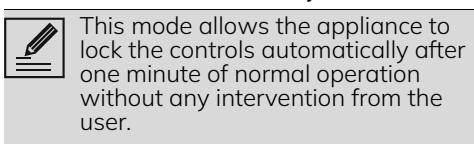

1. After entering the settings menu, turn the temperature knob until the control lock function is selected.



2. Press the temperature knob to confirm.

The indicator light  flashes.

3. Within 10 seconds turn the temperature knob to activate the control lock function.



4. Press the temperature knob to confirm.

- Turn the display knob to select a new setting.



In normal operation, the control lock is indicated by the  indicator light coming on.



Touching or varying the position of the knobs, the display will show the wording  for two seconds.



To release the lock temporarily during cooking, hold the temperature knob down for 5 seconds. One minute after the last setting the lock will become active again.

### Showroom (for showrooms only)



This mode allows the appliance to deactivate all heating elements, while keeping the control panel active.

- After entering the settings menu, turn the temperature knob until the showroom function is selected.



- Press the temperature knob to confirm.
- Turn the temperature knob to activate the showroom function.



- Press the temperature knob to confirm or wait 10 seconds.



The activated showroom is indicated on the display by the  indicator light on.



To use the appliance normally, set this function to OFF.

### Keep warm



This mode allows the appliance after cooking finishes with a cooking cycle for which a duration has been set (if this is not manually interrupted), to keep cooked food warm (at low temperatures) without altering the taste and aromas obtained during cooking.

- After entering the settings menu, turn the temperature knob until the keep warm function is selected.

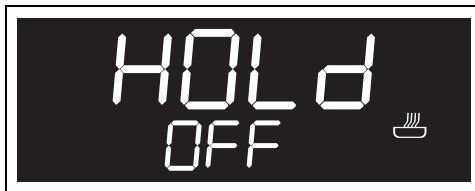

- Press the temperature knob to confirm.
- Turn the temperature knob to activate the keep warm function.



- Press the temperature knob to confirm.



To use the appliance normally, set this function to OFF.

## CLEANING AND MAINTENANCE

### Cleaning the appliance



See General safety instructions.

### Cleaning the surfaces

To keep the surfaces in good condition, they should be cleaned regularly after use. Let

them cool first.

### Ordinary daily cleaning

Always and only use specific products that do not contain abrasives or chlorine-based acids.

Pour the product onto a damp cloth and wipe the surface, rinse thoroughly and dry with a soft cloth or a microfibre cloth.

## Food stains or residues

Do not use steel sponges and sharp scrapers as they will damage the surface. Use normal, non-abrasive products and a wooden or plastic tool, if necessary. Rinse thoroughly and dry with a soft cloth or a microfibre cloth.

Do not allow residues of sugary foods (such as jam) to set inside the oven. If left to set for too long, they might damage the enamel lining of the oven.

## Cleaning the external glass

To clean the external glass, use a first dry cloth and moisten it with the cleaning product; then finish cleaning with a second dry cloth, preferably microfibre, to remove any residue and prevent streaks.



If particularly stubborn dirt is present, it is recommended to use a degreasing product before carrying out the above procedure.

## Cleaning the door

### Door disassembly

For easier cleaning it is recommended to remove the door and place it on a tea towel. To remove the door proceed as follows:

1. Open the door completely and insert two pins into the holes on the hinges indicated in the figure.

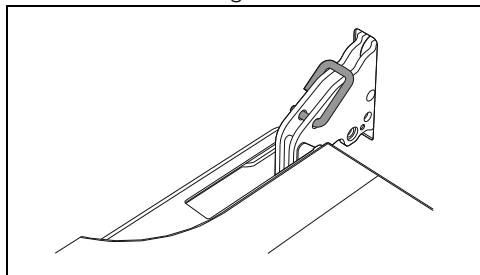

2. Grasp the door on both sides with both hands, lift it forming an angle of around 30° and remove it.

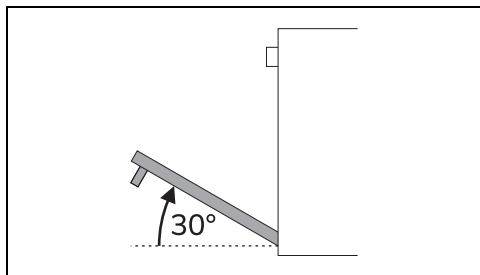

3. To reassemble the door, put the hinges in the relevant slots in the oven, making

sure that grooved sections A are resting completely in the slots.

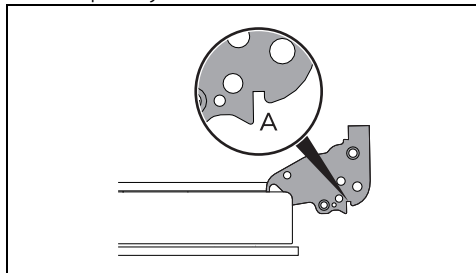

4. Lower the door and once it is in place remove the pins from the holes in the hinges.

### Cleaning the door glazing

The glass in the door should always be kept thoroughly clean. Use absorbent kitchen roll. In case of stubborn dirt, wash with a damp sponge and an ordinary detergent.

### Removing the internal glass panes

For easier cleaning the internal glass panes of the door can be removed.

1. Lock the door with the appropriate pins.
2. Remove the internal glass pane by pulling the rear part gently upwards, following the movement indicated by the arrows 1.

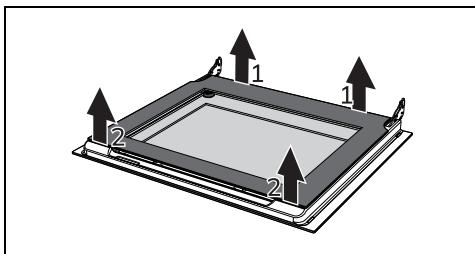

3. Release the front pins following the movement indicated by the arrows 2
4. Then remove the inner glass pane from the front profile.

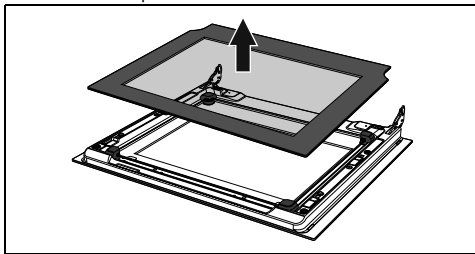

5. Remove the intermediate glass unit by lifting it upwards.

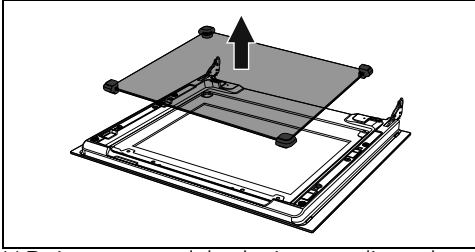

N.B.: in some models, the intermediate glass unit consists of two glasses.

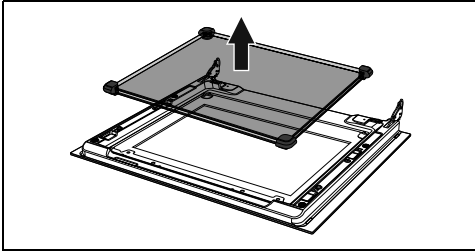

6. Clean the external glass pane and the panes removed previously.

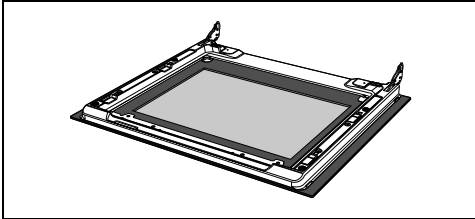

7. Use absorbent kitchen roll. In case of stubborn dirt, wash with a damp sponge and neutral detergent.  
8. Reinsert the intermediate glass unit and reposition the inner glass.

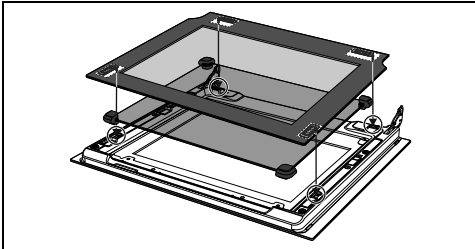

9. Be sure to fit the 4 pins of the inner glass well into their seats on the door.

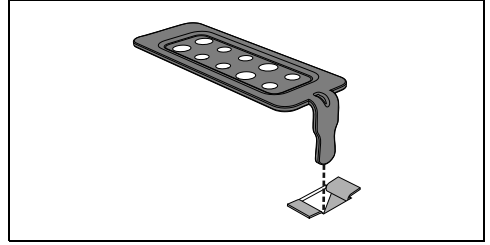

## Cleaning the oven cavity

In order to keep your oven in the best possible condition, clean it regularly after letting it cool down.

Avoid letting food residue dry inside the oven cavity, as this could damage the enamel.

Take out all removable parts before cleaning.

For easier cleaning, it is recommended to remove:

- the door;
- The rack/tray support frames.



In the event you are using specific cleaning products, we recommend running the oven at maximum temperature for 15-20 minutes in order to eliminate any residue.

## Drying

Cooking food generates moisture inside the appliance. This is a normal phenomenon and does not affect the appliance's operation in any way.

Each time you finish cooking:

1. Let the appliance cool down.
2. Remove any dirt from inside the appliance.
3. Dry the interior of the appliance with a soft cloth.
4. Leave the door open until the inside of the appliance has dried completely.

## Removing racks/trays support frames

Removing the rack/tray support frames enables the sides to be cleaned more easily.

To remove the rack/tray support frames:

- Pull the frame towards the inside of the oven cavity to unhook it from its groove A, then slide it out of the seats B at the

back.

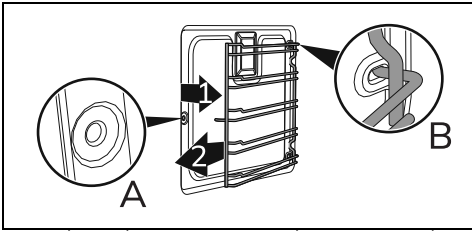

- When cleaning is complete, repeat the above procedures to put the rack/tray support frames back in.

### Special cleaning functions

1. Turn the function knob until the following text appears on the display.



2. Press the temperature knob to access the special functions menu.

### Pyrolytic (on some models only)



See General safety instructions.



Pyrolytic cleaning is an automatic high-temperature cleaning procedure which causes dirt to dissolve. This process makes it possible to clean the inside of the oven very easily.

### Preliminary operations

Before starting the pyrolytic cycle:

- Clean the internal glass pane following the usual cleaning instructions.
- Remove any food residues or large spills from previous cooking operations from the inside of the oven.
- Completely remove all accessories from inside the oven.
- For very stubborn encrustations spray an oven cleaning product onto the glass (read the warnings on the product); leave for 60 minutes, then rinse and dry the glass using kitchen roll or a microfibre cloth.
- If present, remove the temperature probe.
- Remove the rack/tray support frames.
- Close the door.

### Pyrolytic function setting

1. After entering the special functions menu, turn the temperature knob until the Pyrolytic function is selected.



2. Press the temperature knob to confirm the function.

The display shows the Pyrolytic cycle duration (factory set to 2 hours).



3. Turn the temperature knob to set the duration of the Pyrolytic cycle from a minimum of 2 hours to maximum of 3 hours.



Recommended pyrolytic cycle duration:

- Little dirt: L01 - 2:00
- Moderately dirty: L02 - 2:30
- Very dirty: L03 - 3:00

4. Press the temperature knob to confirm the data entered.

Wait 3 seconds to start the function.



5. Two minutes after the Pyrolytic cycle starts, the  indicator light comes on to indicate that the door is locked by a device that prevents the door from being opened.





It is not possible to select any function once the door lock device has been activated.

At the end of the Pyrolytic cycle the flashing wording **STOP** is displayed and a buzzer will sound that can be deactivated

by opening the door and/or pressing/turning any of the two knobs.



 The door is locked until the temperature inside the oven cavity returns to a safe level.

 During the Pyrolytic cycle the fans produce a more intense level of noise due to a greater rotation speed. This is an absolutely normal operation, intended to provide more effective heat dispersal. At the end of the pyrolytic cycle, the fans will continue to operate for long enough to avoid overheating the walls of adjacent units and the front of the oven.

 During the first Pyrolytic cycle, unpleasant odours may occur due to the normal evaporation of oily manufacturing substances. This is an absolutely normal phenomenon which disappears after the first pyrolytic cycle.

 If the pyrolytic cycle gives unsatisfactory results at minimum duration, it is recommended to set a longer time for subsequent cleaning cycles.

### Setting of a programmed Pyrolytic cycle

It is possible to program the Pyrolytic cycle start time like all other cooking functions.

1. After selecting the Pyrolysis function, turn the temperature knob (the indicator light  lights up) to set the time at which you want the Pyrolysis function to end.
2. Wait 3 seconds to confirm the data entered.

The appliance waits until the set start time

to start the Pyrolytic function.

 It is not possible to select any function once the door lock device has been activated. It is always possible to switch the appliance off, by turning the function knob to the 0 position.

### End of pyrolytic function

1. Turn the function knob to position 0 to exit the function.
2. Open the door and collect the residue deposited inside the oven cavity with a damp microfibre cloth.

 We recommend wearing rubber gloves for these operations.

 For easier manual cleaning of parts that are difficult to reach, we recommend removing the door.

## Extraordinary maintenance

### Seal maintenance tips

The seal should be soft and elastic.

- To keep the seal clean, use a non-abrasive sponge and wash with lukewarm water.

### Replacing the internal light bulb

 **Power voltage**  
**Danger of electrocution**

- Unplug the appliance.
- Wear protective gloves.

1. Completely remove all accessories from inside the oven.
2. Remove the rack/tray support frames.
3. Use a tool (e.g. a spoon) to remove the bulb cover.

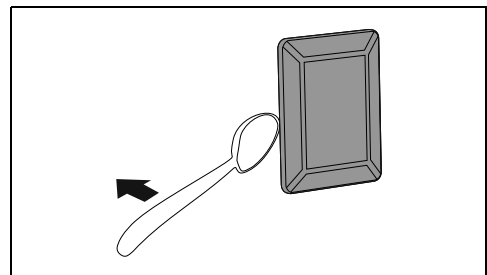

 Take care not to scratch the enamel of the oven cavity wall.

4. Slide out and remove the light bulb.

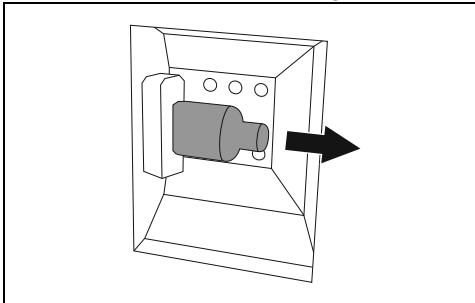

Do not touch the halogen light bulb directly with your fingers, use an insulating material.

5. Replace the light bulb with one of the same type (40 W).
6. Refit the cover. Ensure the moulded part of the glass (A) is facing the door.

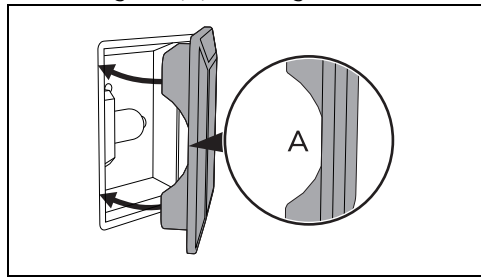

7. Press the cover completely down so that it attaches perfectly to the bulb support.

## INSTALLATION

### Electrical connection



See General safety instructions.

#### General information

Check the mains characteristics against the data indicated on the plate.

The identification plate bearing the technical data, serial number and brand name is visibly positioned on the appliance.

Do not remove this plate for any reason.

The appliance must be connected to ground using a wire that is at least 20 mm longer than the other wires.

The appliance can work in the following modes:

- 220-240 V~

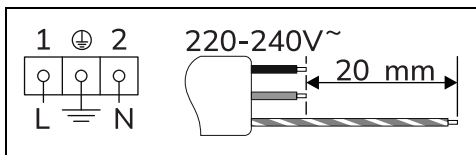

3 x 1.5 mm<sup>2</sup> three-core cable.



The values indicated above refer to the cross section of the internal lead.



The aforementioned power cables are sized taking into account the coincidence factor (in compliance with standard EN 60335-2-6).

#### Fixed connection

Fit the power line with an all-pole circuit

91477B900/F

breaker with a contact separation distance sufficient to provide complete disconnection in category III overvoltage conditions, pursuant to installation regulations.

#### For the Australian/New Zealand market:

The circuit breaker incorporated in the fixed connection must comply with AS/NZS 3000.

#### Connection with plug and socket

Make sure that the plug and socket are of the same type.

Avoid using adapters, gang sockets or shunts as these could cause overheating and a risk of burns.

#### Cable replacement



Power voltage  
Danger of electrocution

- Disconnect the mains power supply.

1. Unscrew the rear casing screws and remove the casing to access the terminal board.

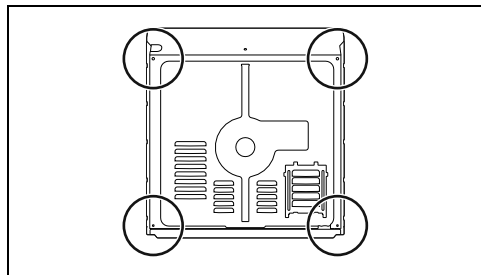

2. Replace the cable.

3. Make sure that the cables (for the oven or any hob) follow the best route in order to avoid any contact with the appliance.

## Positioning



See General safety instructions.

## Position of the power cable

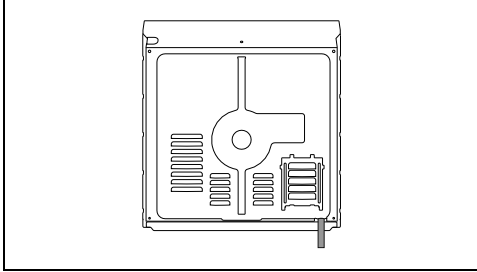

## Front panel seal

Glue the supplied seal to the rear part of the front panel to avoid water or other liquids from leaking in.

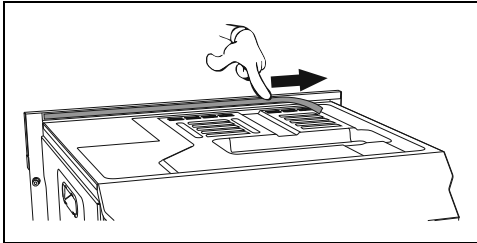

## Fastening bushings

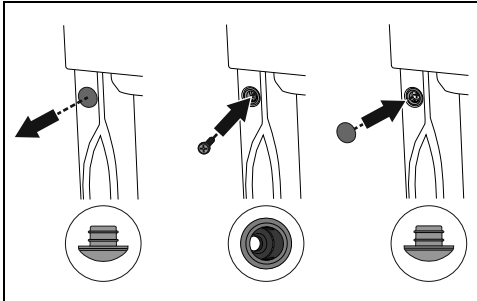

1. Remove the bushing covers on the front of the appliance.
2. Mount the appliance into the recess.
3. Secure the appliance to the cabinet using screws.
4. Cover the bushings with the previously removed covers.

## Appliance overall dimensions (mm)

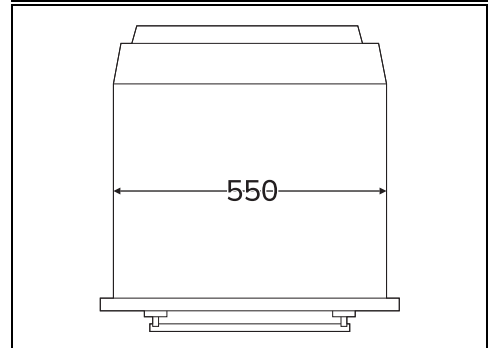
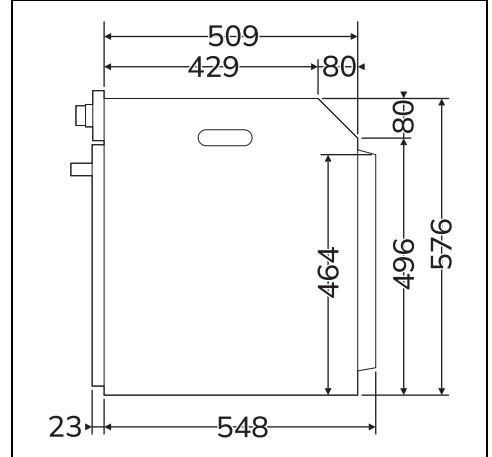
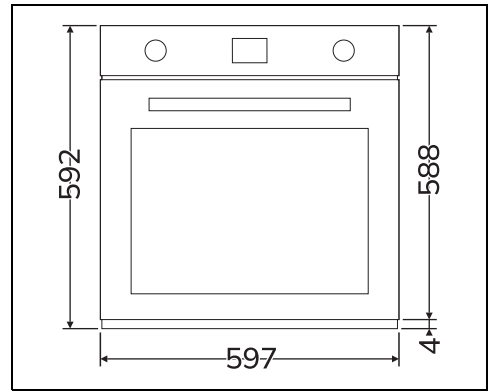

## Mounting into a column (mm)

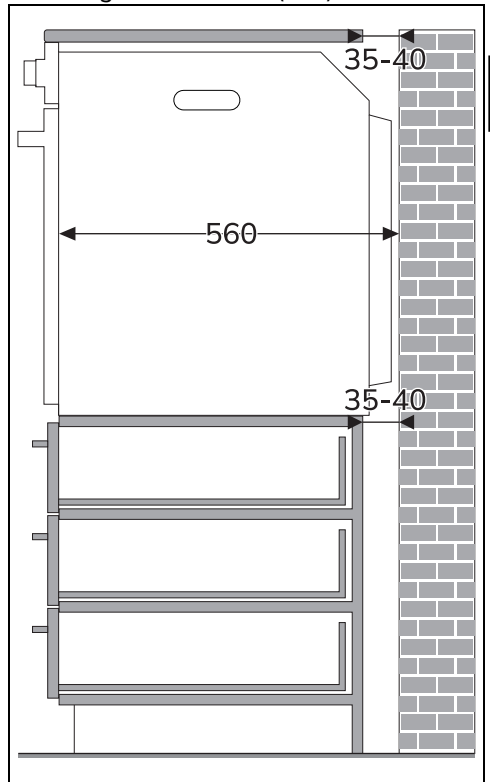
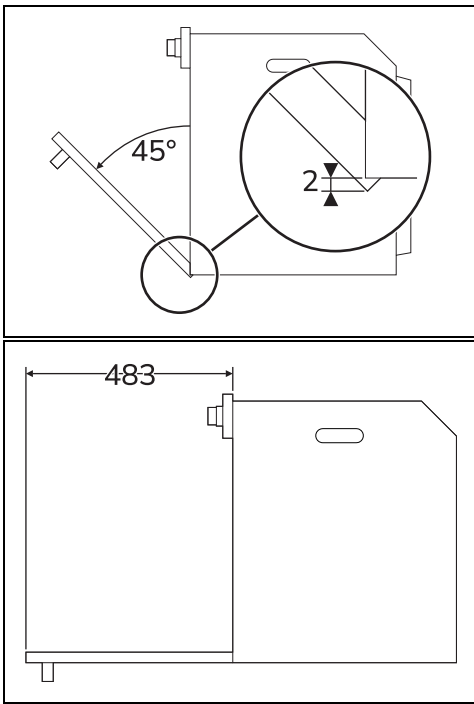

EN



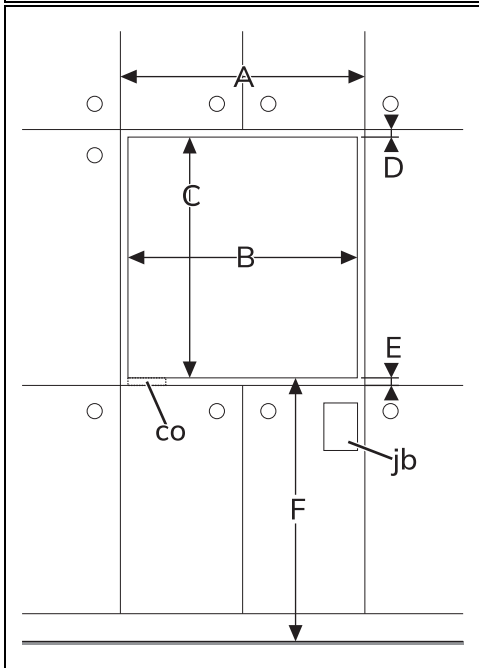
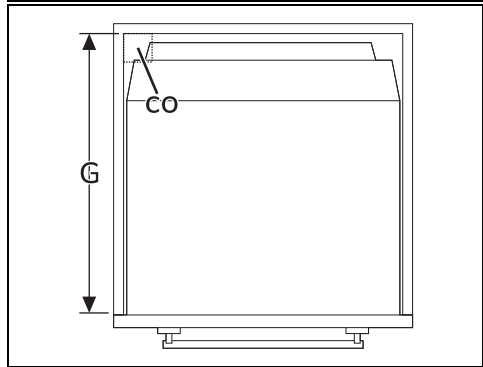
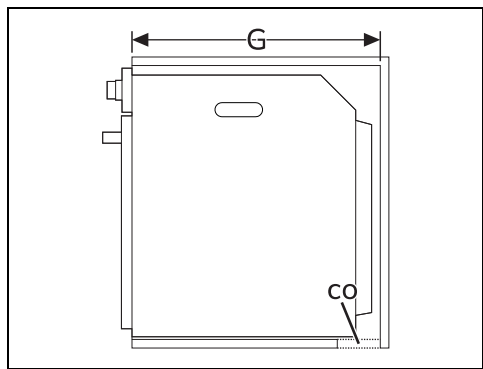
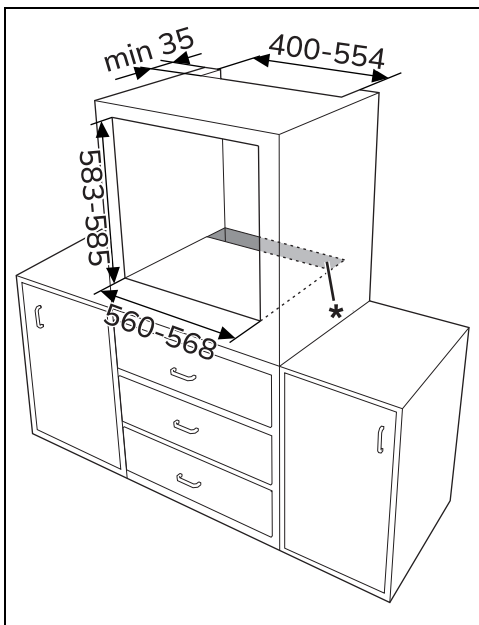

\* Make sure that the cabinet top/  
rear section has an opening approx.  
35-40 mm deep.



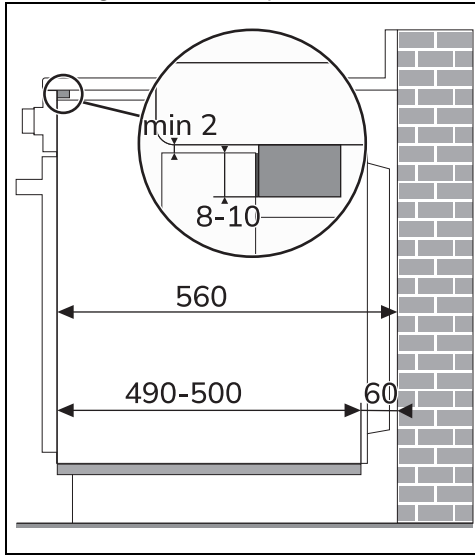

- A min. 603 mm
- B 560 - 568 mm
- C 583 - 585 mm
- D 9 - 11 mm
- E min. 5 mm
- F 121 - 1105 mm
- G min. 560 mm
- H min. 594 mm
- co Cutout for power cord (min. 6 cm<sup>2</sup>)
- jb Electrical connection box

Mounting under worktops (mm)

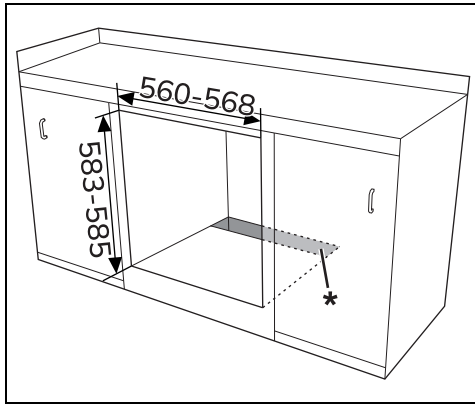

 If the appliance is to be built-in under a worktop, a wooden bar has to be installed order to use the seal that is glued to the back of the front panel to prevent water or other liquids leaking in.



 \* Make sure that the piece of furniture top/rear part has an opening approx. 60 mm deep.

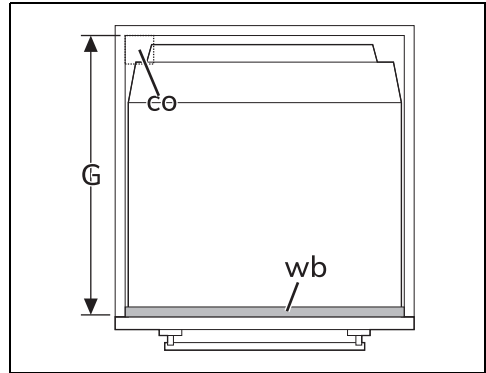
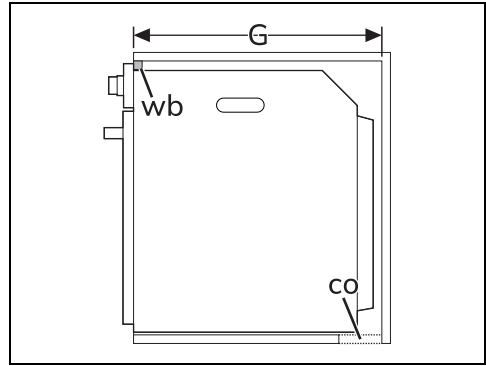
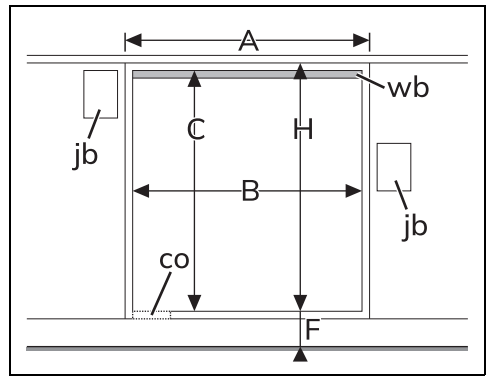

---

A	min. 603 mm
B	560 - 568 mm
C	583 - 585 mm
D	9 - 11 mm
E	min. 5 mm
F	121 - 1105 mm
G	min. 560 mm
H	min. 594 mm
co	Cutout for power cord (min. 6 cm <sup>2</sup> )
jb	Electrical connection box
wb	Wooden bar (recommended)

---