

SI2741DUK



Product Family	Hob
Built-in	Ultra-low profile or Fully Flushed
Dimensions	70/75 cm
Power supply	Electric
Type	Induction
EAN code	8017709334413



Aesthetics



Aesthetics	Universal
Colour	Black
Finishing	Glass
Material	Glass
Glass Type	Ceramic
Glass edge	Straight edge
Type of control setting	Digi Touch
Slider	Red
Control knobs position	Front
Logo	Silk screen
Serigraphy colour	Grey

Program / Functions



No. of induction cook zones	4
Time-setting options	Automatic switch-off
No. of cooking zones with booster	4
Main on/off switch	Yes
Power levels	9
Total no. of cook zones	4

Options



Standard cut out	478-482x555-560 mm	End of cooking acoustic alarm	Yes
End cooking timer	4	Residual time indicator	Yes
Minute minder	1	Control Lock / Child Safety	Yes

Technical Features



Front left - Induction - single - 1.50 kW - Booster 2.00 kW - Ø 21.0 cm
 Rear left - Induction - single - 1.20 kW - Booster 1.60 kW - Ø 15.0 cm
 Rear right - Induction - single - 1.50 kW - Booster 2.00 kW - Ø 21.0 cm
 Front right - Induction - single - 1.20 kW - Booster 1.60 kW - Ø 15.0 cm

Automatic setting according to pan dimension	Yes	Automatic switch off when overheat	Yes
Automatic pan detection	Yes, min 9 cm	Residual heat indicator	Yes
Minimum pan diameter indication	Yes	Protection against accidental start up	Yes

Electrical Connection

Nominal power (W)	2800 W	Frequency (Hz)	50/60 Hz
Current	13 A	Power supply cable length	120 cm
Voltage (V)	220-240 V	Plug	No
Type of electric cable	Single and Double phase		

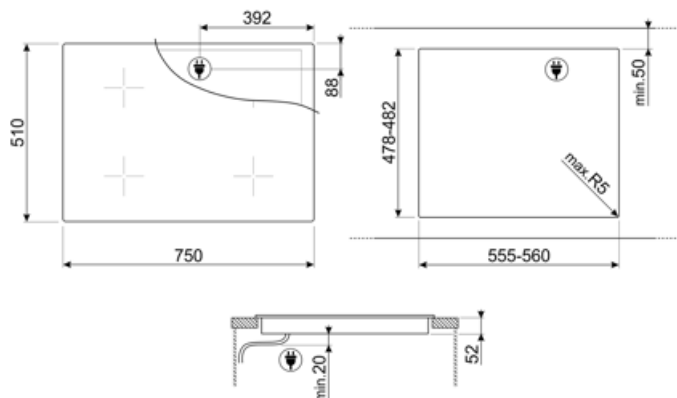

Compatible Accessories



GRILLPLATE

Universal griddle for induction, gas, ceramic and electric hobs. Non-stick surface ideal for cooking meat, cheese and vegetables. Dimensions: 410 x 240 mm.



TPKPLATE











Universal plate for induction, gas, ceramic and electric hobs. Non-stick surface ideal for cooking fish, eggs and vegetables. Dimensions: 410 X 240 mm.



SCRP

Induction and ceramic hobs and teppanyaki scraper

Symbols glossary

	Power booster: option allows the zone to work at full power when very intense cooking is necessary.		Child lock: some models are fitted with a device to lock the programme/cycle so it cannot be accidentally changed.
	Touch control		CUT_OUT_STANDARD_72dpi
	Overheat protection: The safety system that automatically turns off the hob in case of overheating of the control unit.		Induction: The work of these hobs is based on the principle of electromagnetic induction. The heat is generated directly in the bottom of the pan during its contact with the hob.
	Min diameter pot detection of 9 cm		Indication of residual heat: After the glass ceramic hob is switched off the residual heat indicator shows which of the heating zones still remains hot. When the temperature drops below 60 ° C, the indicator goes out.
	Time elapsed: shows how long the cooking zone has been in use.		Timer: All ceramic hobs have a timer which automatically ends cooking after a preset time.