

# SO4602M1NR

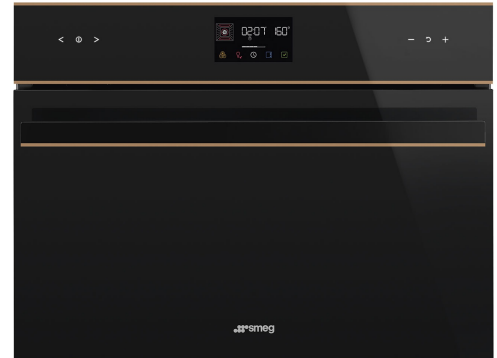

<b>Category</b>	45cm Compact Ovens
<b>Product Family</b>	Oven
<b>Power supply</b>	Electric
<b>Heat source</b>	Electric
<b>Cooking method</b>	Combi Microwave
<b>Galileo cavity</b>	Micro combi
<b>Cleaning system</b>	Vapor Clean
<b>EAN code</b>	8017709331955



## Aesthetics

<b>Aesthetics</b>	Dolce Stil Novo	<b>Glass Type</b>	Eclipse
<b>Colour</b>	Black	<b>Door</b>	Full glass
<b>Finishing</b>	Gloss	<b>Handle</b>	Linea
<b>Design</b>	Flat	<b>Handle Colour</b>	Black
<b>Component finish</b>	Copper	<b>Logo</b>	Applied
<b>Material</b>	Glass		

## Controls









<b>Display name</b>	EvoScreen	<b>Control setting</b>	Touch control
<b>Display technology</b>	LCD		





## Programs / Functions

**No. of cooking functions** 11

**Traditional cooking functions**

 Static	 Fan assisted	 Ciculaire
 ECO	 Large grill	 Base
 Pizza		

## Microwave functions

-  Microwave
-  Microwave + bottom + top + fan
-  Microwave + circulaire + fan
-  Microwave + grill

## Other functions

-  Defrost by time
-  Proving
-  Stone cooking
-  BBQ
-  Air-Fry
-  Sabbath

## Cleaning functions

-  Vapor Clean

## Options



<b>Time-setting options</b> Delay start and automatic end cooking <b>Minute minder</b> Yes <b>Timer</b> 1 <b>Controls Lock / Child Safety</b> Yes	<b>Other options</b> Keep warm, Eco light, Brightness, Tones <b>Showroom demo option</b> Yes <b>Rapid pre-heating</b> Yes
---	--

## Technical Features



<b>Minimum Temperature</b> 25 °C <b>Maximum temperature</b> 250 °C <b>Shelf positions</b> 3 <b>No. of lights</b> 2 <b>Light type</b> Halogen <b>Light power</b> 40 W <b>Light when door is opened</b> Yes <b>Lower heating element power</b> 1200 W <b>Grill element - power</b> 1750 W <b>Circular heating element - Power</b> 1400 W <b>Heating suspended when door is opened</b> Yes <b>Door opening type</b> Standard opening	<b>Door</b> Temperate door <b>Total no. of door glasses</b> 4 <b>Microwave stops when door is opened</b> Yes <b>Soft Close hinges</b> Yes <b>Soft Open</b> Yes <b>Chimney</b> Fixed <b>Cooling system</b> Tangential <b>Cooling duct</b> Single <b>Usable cavity space dimensions (HxWxD)</b> 211x462x401 mm <b>Temperature control</b> Electronic <b>Cavity material</b> Easy clean enamel <b>Microwave screen protection</b> Yes
--	---

## Performance / Energy Label



Net volume of the cavity 40 litres  
 Number of cavities 1

Microwave effective power 800 W

## Accessories Included

Chrome shelf 1  
 Grill mesh 1

Glass tray 1

## Electrical Connection

Voltage 220-240 V  
 Current 15 A  
 Nominal power (W) 3300 W

Frequency (Hz) 50 Hz  
 Power supply cable length 150 cm

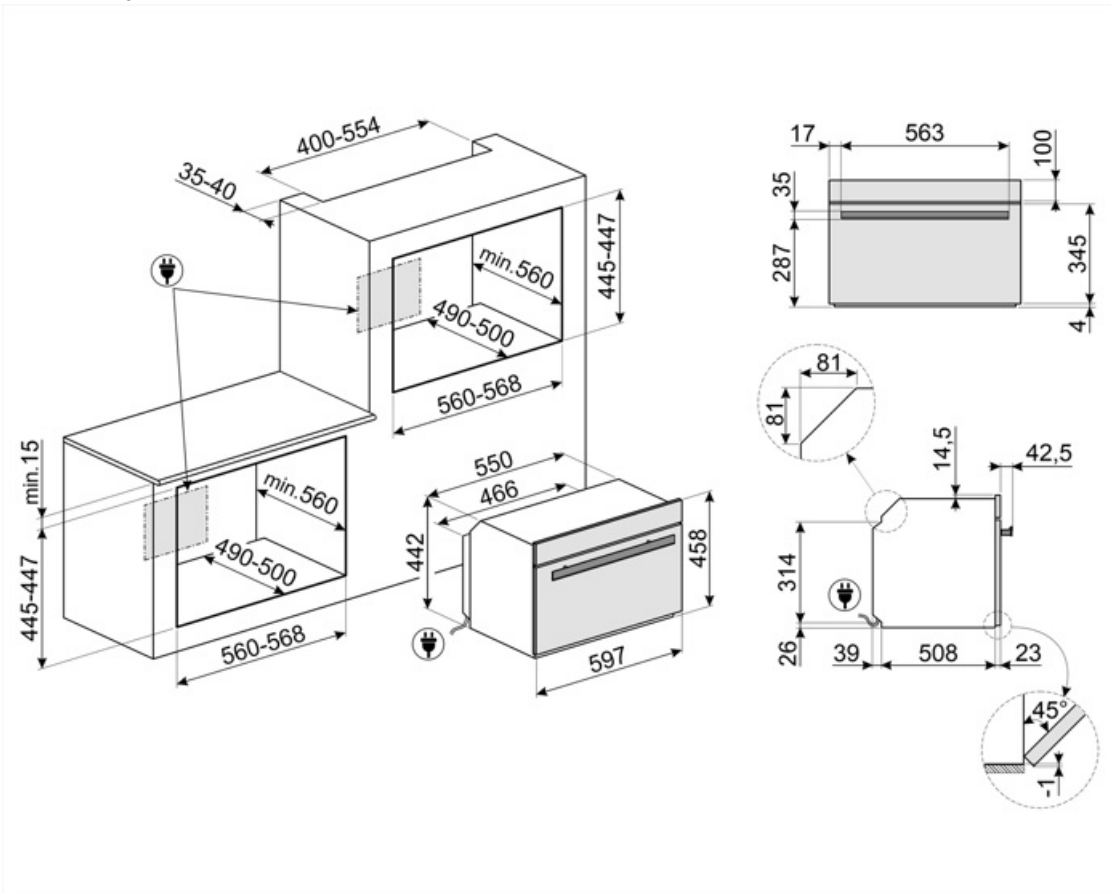

---

## Compatible Accessories



















---

### AIRFRY

Air fryer rack AIRFRY . Ideal for recreating traditional frying in the oven, but with fewer calories and less fat. It allows you to cook quickly and simply dishes such as French fries, fried vegetables and fish, ensuring perfect browning and crispiness.





## Symbols glossary

 <p>Child lock: some models are fitted with a device to lock the programme/cycle so it cannot be accidentally changed.</p>	 <p>Combination microwave: This oven allows to combine two different ways of cooking (Traditional with microwaves). Combined ovens increase cooking opportunities, while providing maximum flexibility of household appliances.</p>
 <p>Air cooling system: to ensure a safe surface temperatures.</p>	 <p>Defrost by time: with this function the time of thawing of foods are determined automatically.</p>
 <p>Quadruple glazed: Number of glazed doors.</p>	 <p>Automatic lighting switches off: for greater energy savings, the lighting switches off automatically after one minute from the start of cooking.</p>
 <p>Electric</p>	 <p>Enamel interior: The enamel interior of all Smeg ovens have a special antacid lining which helps keep the interior clean by reducing the amount of cooking grease adhering to it.</p>
 <p>Fan with upper and lower elements: The elements combined with the fan aim to provide more uniform heat, a similar method to conventional cooking, so pre-heat is required. Most suitable for items requiring slow cooking methods.</p>	 <p>Upper and lower element only: a traditional cooking method best suited for single items located in the centre of the oven. the top pf the oven will always be hottest. Ideal for roast, fruit cakes, bread etc.</p>
 <p>Lower heating element only: This function is ideal for foods that require extra base temperature without browning, e.g. pastry dishes, pizza. Also suitable for slow cooking of stews and casseroles.</p>	 <p>Circulaire: The combination of the fan and circular element around it gives a hot air cooking method. This provides many benefits including no preheat if cook time is more than 20 minutes, no flavour transfer when cooking different foods at the same time, less energy, and shorter cook times. Good for all types of food.</p>
 <p>ECO: The combination of the grill, fan and lower element is particularly suitable for cooking small quantities of food.</p>	 <p>Grill element: Using of grill gives excellent results when cooking meat of medium and small portions, especially when combined with a rotisserie (where possible). Also ideal for cooking sausages and bacon.</p>
 <p>Microwave: Penetrating straight into the food, microwaves cook very quickly and with considerable energy savings. Suitable for cooking without fat, they are also able to thaw and heat food without altering its original appearance and aroma. The microwave function can also be combined with conventional functions with all the resulting advantages. Ideal for all types of food.</p>	 <p>Cooking with the simultaneous use of the heating element in combination with fan and microwave supply.</p>
 <p>Microwave + grill element: The use of the grill results in a perfect browning of the surface of the food. The action of microwaves allows instead of cooking in a short time the internal part of the food.</p>	 <p>Fan combined with traditional cooking, where heat is generated from above and below, provides uniform heat. Adding the microwave function allows the same cooking results in less time.</p>

- 

**Pizza function:** The simultaneous operation of three elements ensures an optimum cooking facility when used with the Smeg pizza stone.



**Compact appliances with a height of 45 cm -** perfect solution to meet the functional requirements of kitchen sets of small height. Available in several types and in different styles.
- 

**Keep warm:** This function allows you to keep precooked foods warm.



**Side lights:** Two opposing side lights increase visibility inside the oven.
- 

**Air at 40°C** provides the perfect environment for proving yeast type dough mixes. Simply select the function and place dough in the cavity for allotted



**Rapid preheat:** The rapid preheat function can be used to reach the selected temperature in just a few minutes.
- 

**Sabbath:** This function allows you to cook food whilst respecting the provisions of the Jewish day of rest.



The oven cavity has 3 different cooking levels.
- 

**Soft close:** all models are equipped with advanced function of smooth closing of the door, which allows the device to close smoothly and quietly.



**Electronic control:** Allows you to maintain temperature inside the oven with the precision 2-3 ° C. This enables to cook meals that are very sensitive to temperature changes, such as cakes, souffles, puddings.
- 

**Touch controls:** Easy to use touch controls allow the appliance to be programmed at the touch of a button.



**Vapor Clean:** a simple cleaning function using steam to loosen deposits in the oven cavity.
- 

The capacity indicates the amount of usable space in the oven cavity in litres.



The capacity indicates the amount of usable space in the oven cavity in litres.
- 

...



**Dedicated cooking function for the double sided plate BBQ.** Suitable for recreating succulent and crispy dishes in the oven with the typical taste of g
- 

**Dedicated cooking function for the Air fryer rack AIRFRY .** Ideal for recreating traditional frying in the oven, but with fewer calories and less fat.



**Dedicated cooking function for the rectangular refractory stone PPR2** Dimensions Ideal for cooking pizzas with the same results as a typical wood-fire