

# SO6102M2G



Category	60cm Single Ovens
Product Family	Oven
Power supply	Electric
Cooking method	Combi Microwave
Galileo cavity	SpeedwaveXL
Cleaning system	Vapor Clean
EAN code	8017709326845



## Aesthetics

Aesthetics	Linea	Serigraphy colour	Black
Colour	Neptune Grey	Serigraphy type	Symbols
Finishing	Matte	Door	Full glass
Design	Flat	Handle	Linea minimal
Material	Glass	Handle Colour	Satin metal and black
Glass Type	Clear1	Logo	Silk screen

## Controls









Display name	EvoScreen	Control setting	Touch control
Display technology	LCD		

## Programs / Functions

No. of cooking functions 11

Traditional cooking functions

 Static	 Fan assisted	 Ciculaire
 ECO	 Large grill	 Base
 Pizza		

## Microwave functions

- Microwave
- Microwave + bottom + top + fan
- Microwave + circulaire + fan
- Microwave + grill

## Other functions

- Defrost by time
- Proving
- Stone cooking
- BBQ
- Air-Fry
- Melt
- Soft
- Pop-corn
- Sabbath

## Cleaning functions

- Vapor Clean

## Options



<b>Time-setting options</b> <b>Minute minder</b> <b>Timer</b> <b>Controls Lock / Child Safety</b>	Delay start and automatic end cooking Yes 1 Yes	<b>Other options</b> <b>Showroom demo option</b> <b>Rapid pre-heating</b>	Keep warm, Eco light, Brightness, Tones Yes Yes
--	--	---	---

## Technical Features



<b>Minimum Temperature</b> <b>Maximum temperature</b> <b>Shelf positions</b> <b>No. of lights</b> <b>Light type</b> <b>User-replaceable light</b> <b>Light power</b> <b>Light when door is opened</b> <b>Lower heating element power</b> <b>Grill element - power</b> <b>Circular heating element - Power</b> <b>Heating suspended when door is opened</b> <b>Door opening type</b>	25 °C 250 °C 5 2 Halogen Yes 40 W Yes 1200 W 1750 W 2000 W Yes Standard opening	<b>Full glass inner door</b> <b>Total no. of door glasses</b> <b>Soft Close hinges</b> <b>Soft Open</b> <b>Inverter</b> <b>Stirrer</b> <b>Chimney</b> <b>Cooling system</b> <b>Cooling duct</b> <b>Speed Reduction Cooling System</b> <b>Usable cavity space dimensions (HxWxD)</b> <b>Temperature control</b> <b>Cavity material</b>	Yes 4 Yes Yes Yes Yes Double Centrifugal Double Yes 353x470x397 mm Electronic Easy clean enamel
---	---	---	---

Door

Cool

## Performance / Energy Label



Net volume of the cavity 68 litres  
Number of cavities 1

Microwave effective power 900 W

## Accessories Included



Chrome shelf 1  
Enamelled deep tray (50mm) 1  
Grill mesh 1

Glass tray 1  
Telescopic Guide rails, partial Extraction 1

## Electrical Connection

Voltage 220-240 V  
Current 13 A  
Nominal power (W) 3000 W

Frequency (Hz) 50/60 Hz  
Power supply cable length 150 cm

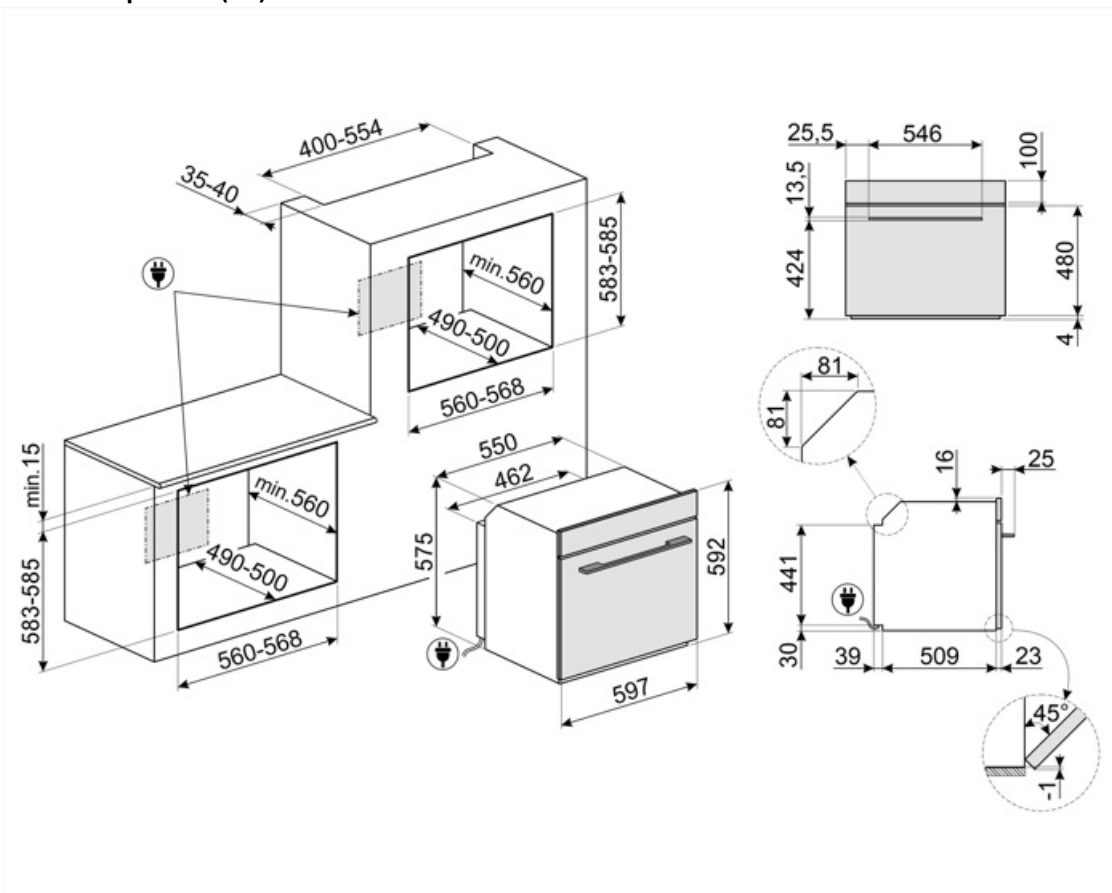

## Compatible Accessories

### AIRFRY

Air fryer rack AIRFRY . Ideal for recreating traditional frying in the oven, but with fewer calories and less fat. It allows you to cook quickly and simply dishes such as French fries, fried vegetables and fish, ensuring perfect browning and crispiness.



### ET20

Enamelled tray, 20mm deep



### GTP2

Partially extractable telescopic guides (1 level), suitable for traditional ovens. Made in stainless steel, they guarantee stability and facilitate the smooth extraction of the trays.



### PALPZ

Pizza shovel with fold away handle width: 315mm length : 325mm



### SFLK1

Child lock



### BBQ

Double sided plate BBQ. Suitable for recreating succulent and crispy dishes in the oven with the typical taste of grilled cooking. The ribbed side is particularly suitable for meats and cheeses. The smooth side for fish, seafood and vegetables.



### ET50

Enamelled tray, 50mm deep



### GTT2

Totally extractable telescopic guides (1 level), suitable for traditional ovens. Made in stainless steel, they guarantee stability and facilitate the smooth extraction of the trays.



### PR3845X

Antifingerprint stainless steel. Cover for furniture in column installation of more ovens



### STONE

Rectangular refractory stone. Ideal for cooking pizzas with the same results as a typical wood-fired oven. Can also be used for baking bread, focaccias and other recipes such as pies, flans or biscuits Dimensions:L42 x H1,8 x P37,5 cm.



## Alternative products



















---





**SO6102M2B3**



Black



## Symbols glossary



 <p>Dedicated cooking function for the double sided plate BBQ. Suitable for recreating succulent and crispy dishes in the oven with the typical taste of g</p>	 <p>Child lock: some models are fitted with a device to lock the programme/cycle so it cannot be accidentally changed.</p>
 <p>Chimney: The double chimney technology creates a special airflow inside the cavity that reduce the condensation inside the cavity during microwave cooking.</p>	 <p>Combination microwave: This oven allows to combine two different ways of cooking (Traditional with microwaves). Combined ovens increase cooking opportunities, while providing maximum flexibility of household appliances.</p>
 <p>Defrost by time: with this function the time of thawing of foods are determined automatically.</p>	 <p>...</p>
 <p>Quadruple glazed: Number of glazed doors.</p>	 <p>Automatic lighting switches off: for greater energy savings, the lighting switches off automatically after one minute from the start of cooking.</p>
 <p>Electric</p>	 <p>Enamel interior: The enamel interior of all Smeg ovens have a special antacid lining which helps keep the interior clean by reducing the amount of cooking grease adhering to it.</p>
 <p>Fresh Touch: Most of Smeg ovens have a "cool door." Thanks to the combination of tangential cooling and internal heat-reflecting glasses, the temperature on the outer surface of the door is maintained below 50° C. In addition to providing safety, this system protects the sides of the furniture from overheating by the oven.</p>	 <p>Dedicated cooking function for the Air fryer rack AIRFRY . Ideal for recreating traditional frying in the oven, but with fewer calories and less fat.</p>
 <p>Fan with upper and lower elements: The elements combined with the fan aim to provide more uniform heat, a similar method to conventional cooking, so pre-heat is required. Most suitable for items requiring slow cooking methods.</p>	 <p>Upper and lower element only: a traditional cooking method best suited for single items located in the centre of the oven. the top pf the oven will always be hottest. Ideal for roast, fruit cakes, bread etc.</p>
 <p>Lower heating element only: This function is ideal for foods that require extra base temperature without browning, e.g. pastry dishes, pizza. Also suitable for slow cooking of stews and casseroles.</p>	 <p>Circulaire: The combination of the fan and circular element around it gives a hot air cooking method. This provides many benefits including no preheat if cook time is more than 20 minutes, no flavour transfer when cooking different foods at the same time, less energy, and shorter cook times. Good for all types of food.</p>
 <p>ECO: The combination of the grill, fan and lower element is particularly suitable for cooking small quantities of food.</p>	 <p>Grill element: Using of grill gives excellent results when cooking meat of medium and small portions, especially when combined with a rotisserie (where possible). Also ideal for cooking sausages and bacon.</p>



-  **Microwave:** Penetrating straight into the food, microwaves cook very quickly and with considerable energy savings. Suitable for cooking without fat, they are also able to thaw and heat food without altering its original appearance and aroma. The microwave function can also be combined with conventional functions with all the resulting advantages. Ideal for all types of food.



 **Cooking with the simultaneous use of the heating element in combination with fan and microwave supply.**
-  **Microwave + grill element:** The use of the grill results in a perfect browning of the surface of the food. The action of microwaves allows instead of cooking in a short time the internal part of the food.



 **Fan combined with traditional cooking,** where heat is generated from above and below, provides uniform heat. Adding the microwave function allows the same cooking results in less time.
-  **Pizza function:** The simultaneous operation of three elements ensures an optimum cooking facility when used with the Smeg pizza stone.



 **All glass inner door:** All glass inner door, a single flat surface which is simple to keep clean.
-  **Keep warm:** This function allows you to keep precooked foods warm.



 **Side lights:** Two opposing side lights increase visibility inside the oven.
-  **Air at 40°C** provides the perfect environment for proving yeast type dough mixes. Simply select the function and place dough in the cavity for allotted



 **Rapid preheat:** The rapid preheat function can be used to reach the selected temperature in just a few minutes.
-  **Sabbath:** This function allows you to cook food whilst respecting the provisions of the Jewish day of rest.

 **The oven cavity has 5 different cooking levels.**
-  **Soft close:** all models are equipped with advanced function of smooth closing of the door, which allows the device to close smoothly and quietly.

 **Telescopic rails:** allow you to pull out the dish and check it without having to remove it from the oven entirely.
-  **Electronic control:** Allows you to maintain temperature inside the oven with the precision 2-3 ° C. This enables to cook meals that are very sensitive to temperature changes, such as cakes, souffles, puddings.

 **Touch controls:** Easy to use touch controls allow the appliance to be programmed at the touch of a button.
-  **Vapor Clean:** a simple cleaning function using steam to loosen deposits in the oven cavity.

 **The capacity indicates the amount of usable space in the oven cavity in litres.**
-  **The capacity indicates the amount of usable space in the oven cavity in litres.**

 **Stirrer Active and controlled microwave distribution.** The Microwave Stirrer fan distributes the waves evenly within the oven, reducing the need for a turntable.
-  **The inverter technology** allows to generate microwaves continuously and at the desired power The constant flow, without on and off cycles, allows you to precisely control the temperature, reduce times, avoids wasting energy and allows you to obtain excellent cooking, defrosting and re-heating results, thanks to the smaller difference between core and surface temperature in food

 **Dedicated cooking function for the rectangular refractory stone PPR2** Dimensions Ideal for cooking pizzas with the same results as a typical wood-fire



Function to melt butter and chocolate without using the bain-marie



Function to soften butter and cheese It is useful for quickly bringing frozen desserts to serving temperature The function can also be used to soften ice cream



Function for the preparation of popcorn packaged in bags