

SOP6302S2PX



Category	60cm Single Ovens
Product Family	Oven
Power supply	Electric
Heat source	Electric
Cooking method	Combi Steam
Galileo cavity	SteamOne
Cleaning system	Pyrolytic
EAN code	8017709302092



Aesthetics

Aesthetics	Classic	Serigraphy type	Symbols
Colour	Stainless steel	Door	With 2 horizontal strips
Finishing	Fingerproof	Handle	Classic
Design	Flat	Handle Colour	Steel effect
Material	Stainless steel	Logo	Embossed
Glass Type	Eclipse	Control knobs	Classic
Serigraphy colour	Black		

Controls

			
Display name	EvoScreen	Control setting	Knobs & touch buttons
Display technology	LCD	No. of controls	2

Programs / Functions

No. of cooking functions	12
--------------------------	----

Traditional cooking functions



Static



Fan assisted



Circulaire



Turbo (circulaire + bottom + upper + fan)



ECO



Large grill



Base



Pizza

Cooking functions with steam



Steam + bottom + upper + fan



Steam + circulaire + fan

Turbo

Grill + fan

Other Steam functions



Tank cleaning



Water outlet



Water input



Descaling

Other functions



Defrost by time



Proving



Stone cooking



BBQ



Air-Fry



Sabbath

Cleaning functions



Pyrolytic

Options



Time-setting options

Delay start and automatic end cooking

Minute minder

Yes

Timer

1

Controls Lock / Child Safety

Yes

Other options

Keep warm, Eco light, Brightness, Tones

Cooking with probe thermometer

Yes

Showroom demo option

Yes

Rapid pre-heating

Yes

Technical Features



Minimum Temperature	25 °C	Removable inner door	Yes
Maximum temperature	280 °C	Total no. of door glasses	4
Shelf positions	5	Soft Close hinges	Yes
No. of lights	2	Soft Open	Yes
Light type	Halogen	Chimney	Fixed
User-replaceable light	Yes	Cooling system	Tangential
Light power	40 W	Cooling duct	Double
Light when door is opened	Yes	Speed Reduction Cooling System	Yes
Lower heating element power	1200 W	Door Lock During Pyrolysis	Yes
Grill element - power	1750 W	Steam range	20 - 40%
Circular heating element - Power	2000 W	Usable cavity space dimensions (HxWxD)	353x470x401 mm
Heating suspended when door is opened	Yes	Temperature control	Electronic
Door opening type	Standard opening	Cavity material	Easy clean enamel
Door	Cool	Water loading	Drawer, manual
Removable door	Yes	Tank capacity	0,8 l
Full glass inner door	Yes		

Performance / Energy Label



Energy efficiency class	A+	Energy consumption in forced air convection	2,45 MJ
Net volume of the cavity	68 litres	Energy consumption per cycle in fan-forced convection	0,68 kWh
Energy consumption per cycle in conventional mode	1,09 kWh	Number of cavities	1
Energy consumption in conventional mode	3,92 MJ	Energy efficiency index	81 %

Accessories Included



Chrome shelf	1	Grill mesh	1
Enamelled tray (20mm)	1	Temperature probe	Yes, single point
Enamelled deep tray (50mm)	1		

Electrical Connection

Voltage	220-240 V	Frequency (Hz)	50/60 Hz
Current	13 A		

Nominal power (W)

3000 W

Power supply cable length

150 cm

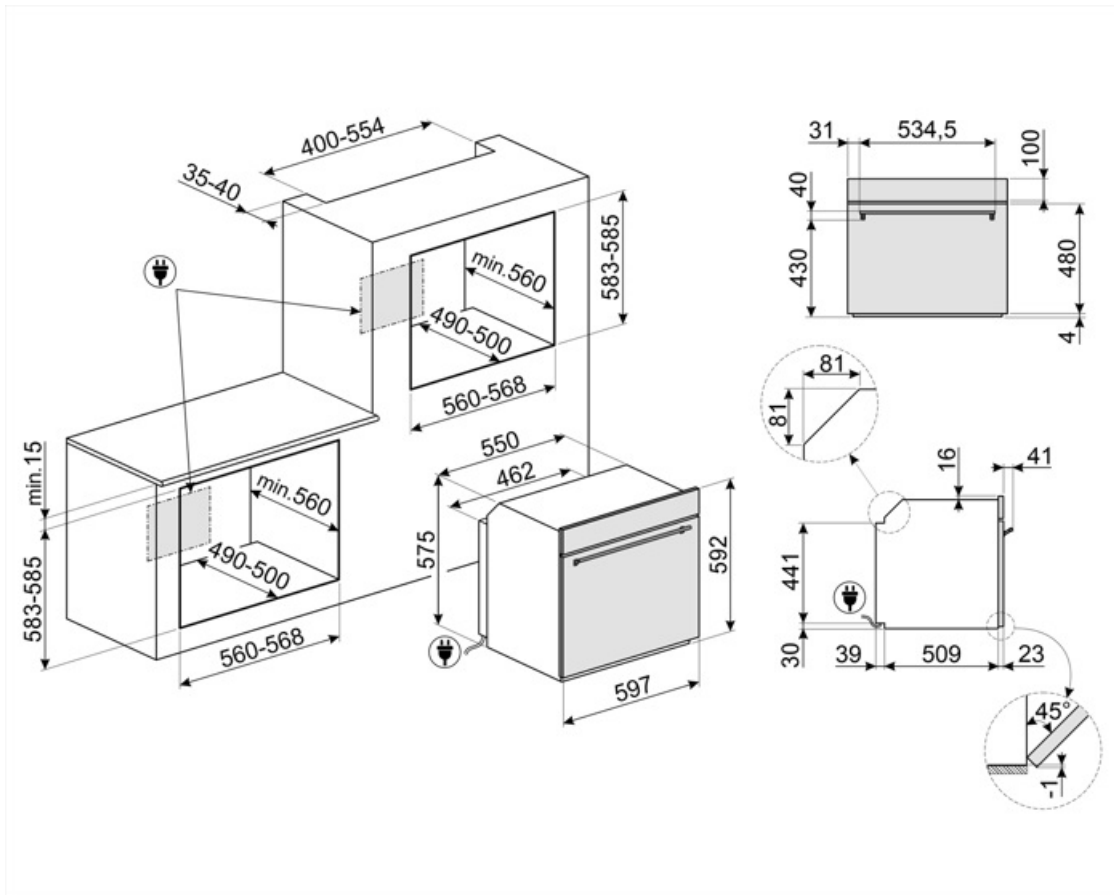

Compatible Accessories

AIRFRY

Air fryer rack AIRFRY . Ideal for recreating traditional frying in the oven, but with fewer calories and less fat. It allows you to cook quickly and simply dishes such as French fries, fried vegetables and fish, ensuring perfect browning and crispiness.



ET20

Enamelled tray, 20mm deep



GTP2

Partially extractable telescopic guides (1 level), suitable for traditional ovens. Made in stainless steel, they guarantee stability and facilitate the smooth extraction of the trays.



PALPZ

Pizza shovel with fold away handle width: 315mm length : 325mm



SFLK1

Child lock



BBQ

Double sided plate BBQ. Suitable for recreating succulent and crispy dishes in the oven with the typical taste of grilled cooking. The ribbed side is particularly suitable for meats and cheeses. The smooth side for fish, seafood and vegetables.



ET50

Enamelled tray, 50mm deep



GTT2

Totally extractable telescopic guides (1 level), suitable for traditional ovens. Made in stainless steel, they guarantee stability and facilitate the smooth extraction of the trays.



PR3845X

Antifingerprint stainless steel. Cover for furniture in column installation of more ovens























STONE



Rectangular refractory stone. Ideal for cooking pizzas with the same results as a typical wood-fired oven. Can also be used for baking bread, focaccias and other recipes such as pies, flans or biscuits Dimensions:L42 x H1,8 x P37,5 cm.







Symbols glossary



 <p>Dedicated cooking function for the double sided plate BBQ. Suitable for recreating succulent and crispy dishes in the oven with the typical taste of g</p>	 <p>Manual water loading system: It is possible to load the tank in less than 40 seconds. The loading is done manually thanks to a special funnel included.</p>
 <p>Child lock: some models are fitted with a device to lock the programme/cycle so it cannot be accidentally changed.</p>	 <p>A+: Energy efficiency class A+ helps to save up to 10% energy compared to class A. Maximum performance with minimum consumption is guaranteed.</p>
 <p>Combination steam: ovens can be used either as a steam oven, or as a traditional oven, or alternatively the two methods can be combined.</p>	 <p>Air cooling system: to ensure a safe surface temperatures.</p>
 <p>Defrost by time: with this function the time of thawing of foods are determined automatically.</p>	 <p>Descaling function: Is essential to remove excess deposits of limestone in the tank and allow the proper operation of the product. The need to perform this operation is signaled by the product itself.</p>
 <p>...</p>	 <p>Quadruple glazed: Number of glazed doors.</p>
 <p>Automatic lighting switches off: for greater energy savings, the lighting switches off automatically after one minute from the start of cooking.</p>	 <p>Electric</p>
 <p>Enamel interior: The enamel interior of all Smeg ovens have a special antacid lining which helps keep the interior clean by reducing the amount of cooking grease adhering to it.</p>	 <p>Fingerprint proof stainless steel: Fingerprint proof stainless steel keeps stainless steel looking as good as new.</p>
 <p>Fresh Touch: Most of Smeg ovens have a "cool door." Thanks to the combination of tangential cooling and internal heat-reflecting glasses, the temperature on the outer surface of the door is maintained below 50° C. In addition to providing safety, this system protects the sides of the furniture from overheating by the oven.</p>	 <p>Dedicated cooking function for the Air fryer rack AIRFRY . Ideal for recreating traditional frying in the oven, but with fewer calories and less fat.</p>
 <p>Fan with upper and lower elements: The elements combined with the fan aim to provide more uniform heat, a similar method to conventional cooking, so pre-heat is required. Most suitable for items requiring slow cooking methods.</p>	 <p>Upper and lower element only: a traditional cooking method best suited for single items located in the centre of the oven. the top pf the oven will always be hottest. Ideal for roast, fruit cakes, bread etc.</p>
 <p>Lower heating element only: This function is ideal for foods that require extra base temperature without browning, e.g. pastry dishes, pizza. Also suitable for slow cooking of stews and casseroles.</p>	 <p>Circulaire: The combination of the fan and circular element around it gives a hot air cooking method. This provides many benefits including no preheat if cook time is more than 20 minutes, no flavour transfer when cooking different foods at the same time, less energy, and shorter cook times. Good for all types of food.</p>



-  **ECO:** The combination of the grill, fan and lower element is particularly suitable for cooking small quantities of food.



 **Grill element:** Using of grill gives excellent results when cooking meat of medium and small portions, especially when combined with a rotisserie (where possible). Also ideal for cooking sausages and bacon.
-  **Pizza function:** The simultaneous operation of three elements ensures an optimum cooking facility when used with the Smeg pizza stone.



 **Fan combined with traditional cooking,** where heat is generated from above and below, provides uniform heat. Adding the steam function allows the same cooking results in less time.
-  **Circulaire element with steam:** Cooking with the simultaneous use of the circular heating element in combination with fan and steam supply.



 **FUN_STEAM_OTHER_WATER_IN_OUT_72dpi**
-  **Circulaire with upper and lower elements:** The use of the fan with both elements allows food to be cooked quickly and effectively, ideal for large joints that require thorough cooking. It offers a similar result to rotisserie, moving the heat around the food, instead of moving the food itself, enabling any size or shape to be cooked.



 **All glass inner door:** All glass inner door, a single flat surface which is simple to keep clean.
-  **The inner door glass:** can be removed with a few quick movements for cleaning.



 **Keep warm:** This function allows you to keep precooked foods warm.
-  **Side lights:** Two opposing side lights increase visibility inside the oven.



 **Pyrolytic:** Pyrolytic cleaning cycles can be selected as necessary to automatically clean the oven interior.
-  **Cooking with temperature probe:** It is possible to display the temperature detected by the probe and set a target temperature that the dish must reach. When the core of the dish reaches the desired temperature, cooking stops

 **Air at 40°C** provides the perfect environment for proving yeast type dough mixes. Simply select the function and place dough in the cavity for allotted
-  **Rapid preheat:** The rapid preheat function can be used to reach the selected temperature in just a few minutes.

 **Sabbath:** This function allows you to cook food whilst respecting the provisions of the Jewish day of rest.
-  **The oven cavity has 5 different cooking levels.**

 **Soft close:** all models are equipped with advanced function of smooth closing of the door, which allows the device to close smoothly and quietly.
-  **To guarantee the optimal functioning of the appliance,** it is suggested to carry out the tank cleaning roughly once every 2-3 months.

 **Electronic control:** Allows you to maintain temperature inside the oven with the precision 2-3 ° C. This enables to cook meals that are very sensitive to temperature changes, such as cakes, souffles, puddings.
-  **The capacity indicates the amount of usable space in the oven cavity in litres.**

 **The capacity indicates the amount of usable space in the oven cavity in litres.**
-  **Dedicated cooking function for the rectangular refractory stone PPR2 Dimensions** Ideal for cooking pizzas with the same results as a typical wood-fire

