

TR62BL

Cooker size	60x60 cm
N. of cavities with energy label	2
Cavity heat source	Electric
Hob type	Gas
Type of main oven	Thermo-ventilated
Type of second oven	Static
EAN code	8017709210625
Energy efficiency class	A
Energy efficiency class, second cavity	A



Aesthetics



Aesthetics	Victoria	Control knobs	Smeg Victoria
Design	Victoria	Controls colour	Stainless steel
Colour	Black	No. of controls	6
Finishing	Gloss	Serigraphy colour	Silver
Command panel finish	Enamelled metal	Display	electronic 5 buttons
Logo	assembled 50's	Door	With frame
Logo position	Upstand	Glass type	Black
Upstand	Yes	Handle	Smeg Victoria
Hob colour	Black enamel	Handle Colour	Brushed stainless steel
Type of pan stands	Cast Iron	Plinth	Anthracite
Type of control setting	Control knobs		

Programs / Functions

No. of cooking functions 4

Traditional cooking functions



Static



Small grill



Large grill



Base

Hob technical features

UR

Total no. of cook zones 4

Front left - Gas - 2UR (dual) - 4.20 kW

Rear left - Gas - Semi Rapid - 1.80 kW

Rear right - Gas - Semi Rapid - 1.80 kW

Front right - Gas - AUX - 1.00 kW

Type of gas burners Standard

Gas safety valves Yes

Automatic electronic ignition Yes

Burner caps Matte black enamelled

Main Oven Technical Features



No. of lights 1
 Net volume of the cavity 61 litres
 Gross volume, 1st cavity 70 l
 Cavity material Easy clean enamel
 Shelf positions 4
 Type of shelves Metal racks
 Light type Halogen
 Light power 40 W
 Cooking time setting Start and Stop
 Removable door Yes

Full glass inner door Yes
 Removable inner door Yes
 Total no. of door glasses 2
 No. of thermo-reflective door glasses 1
 Safety Thermostat Yes
 Cooling system Tangential
 Usable cavity space dimensions (HxWxD) 316x460x412 mm
 Temperature control Electro-mechanical
 Circular heating element - Power 2700 W

Options Main Oven

Timer Yes
 End of cooking acoustic alarm Yes

Minimum Temperature 50 °C
 Maximum temperature 245 °C

Second Oven Technical Features



Net volume of the second cavity 35 litres
 Gross volume, 2nd cavity 41 l
 Cavity material Easy clean enamel
 Shelf positions 2
 Type of shelves Metal racks
 No. of lights 1
 Light type Halogen
 Light power 40 W
 Removable door Yes
 Full glass inner door Yes
 Removable inner door Yes

No. thermo-reflective door glasses 1
 Safety Thermostat Yes
 Cooling system Tangential
 Usable cavity space dimensions (HxWxD) 169x440x443 mm
 Temperature control Electro-mechanical
 Lower heating element - power 1200 W
 Upper heating element - Power 1000 W
 Grill element - power 1700 W
 Large grill - Power 2700 W
 Grill type Electric

No. total door glasses	2	Tilting grill	Yes
------------------------	---	---------------	-----

Options Auxiliary Oven

Minimum Temperature	50 °C	Maximum temperature	245 °C
---------------------	-------	---------------------	--------

Accessories included for Main Oven & Hob



Moka stand	1	Grill mesh	1
Chrome shelf with back and side stop	2	Telescopic Guide rails, partial Extraction	1
40mm deep tray	1		

Accessories included for Secondary Oven

Chrome shelf with back and side stop	1	Grill mesh	1
40mm deep tray	1		

Electrical Connection

Max Power Draw	5500 W	Power supply cable length	120 cm
Current	24 A	Additional connection modalities	Yes, Double and Three Phase
Voltage	220-240 V	Frequency	50/60 Hz
Voltage 2 (V)	380-415 V	Terminal block	5 poles
Type of electric cable	Yes, Single phase		

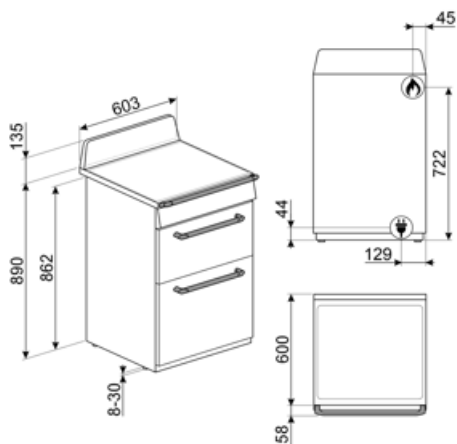

Compatible Accessories

AIRFRY

Air fryer rack AIRFRY . Ideal for recreating traditional frying in the oven, but with fewer calories and less fat. It allows you to cook quickly and simply dishes such as French fries, fried vegetables and fish, ensuring perfect browning and crispiness.



BGTR9

Cast iron grill plate suitable for 90 cm and 100cm Victoria, 60 and 90cm Master and Symphony cookers



BN640

Enamelled tray, 40mm deep

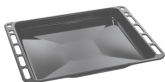

GTP

Partially extractable telescopic guides (1 level) Extraction: 300 mm Material: Stainless steel AISI 430 polished



KIT1TR6N

Splashback, 60x75 cm suitable for 60 cm Victoria cookers, black



PALPZ

Pizza shovel with fold away handle width: 315mm length : 325mm



SMOLD

Set of 7 silicone moulds for ice creams, ice lollies, pralines, ice cubes or to portion food. Usable from -60°C to +230°C

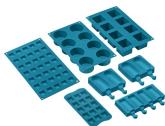

BBQ

Double sided plate BBQ. Suitable for recreating succulent and crispy dishes in the oven with the typical taste of grilled cooking. The ribbed side is particularly suitable for meats and cheeses. The smooth side for fish, seafood and vegetables.



BN620-1

Enamelled tray, 20mm deep



BNP608T

Teflon-coated tray, 8mm depth, to be placed on the grid



GTT

Totally extractable telescopic guides (1 level) Extraction: 433 mm Material: Stainless steel AISI 430 polished



KITH60

Height extension kit (950 mm), suitable for TR60 cookers



SFLK1

Child lock



























STONE

Rectangular refractory stone. Ideal for cooking pizzas with the same results as a typical wood-fired oven. Can also be used for baking bread, focaccias and other recipes such as pies, flans or biscuits Dimensions:L42 x H1,8 x P37,5 cm.



Symbols glossary

	Heavy duty cast iron pan stands: for maximum stability and strength.		A: Product drying performance, measured from A+++ to D / G depending on the product family
	Installation in column: Installation in column		Knobs control
	Air cooling system: to ensure a safe surface temperatures.		Double glazed doors: Number of glazed doors.
	Enamel interior: The enamel interior of all Smeg ovens have a special antacid lining which helps keep the interior clean by reducing the amount of cooking grease adhering to it.		Upper and lower element only: a traditional cooking method best suited for single items located in the centre of the oven. the top pf the oven will always be hottest. Ideal for roast, fruit cakes, bread etc.
	Lower heating element only: This function is ideal for foods that require extra base temperature without browning, e.g. pastry dishes, pizza. Also suitable for slow cooking of stews and casseroles.		Circulaire: The combination of the fan and circular element around it gives a hot air cooking method. This provides many benefits including no preheat if cook time is more than 20 minutes, no flavour transfer when cooking different foods at the same time, less energy, and shorter cook times. Good for all types of food.
	Grill element: Using of grill gives excellent results when cooking meat of medium and small portions, especially when combined with a rotisserie (where possible). Also ideal for cooking sausages and bacon.		Half grill: For rapid cooking and browning of foods. Best results can be obtained by using the top shelf for small items, the lower shelves for larger ones, such as chops or sausages. For half grill heat is generated only at the centre of the element, so is ideal for smaller quantities.
	Light		All glass inner door: All glass inner door, a single flat surface which is simple to keep clean.
	The inner door glass: can be removed with a few quick movements for cleaning.		Side lights: Two opposing side lights increase visibility inside the oven.
	The oven cavity has 2 different cooking levels.		The oven cavity has 4 different cooking levels.
	Telescopic rails: allow you to pull out the dish and check it without having to remove it from the oven entirely.		Electronic control: Allows you to maintain temperature inside the oven with the precision 2-3 ° C. This enables to cook meals that are very sensitive to temperature changes, such as cakes, souffles, puddings.
	Tilting grill: the tilting grill can be easily unhooked to move the heating element and clean the roof of the appliance in one simple step.		Ultra rapid burners: Powerful ultra rapid burners offer up to 5kw of power.
	The capacity indicates the amount of usable space in the oven cavity in litres.		The capacity indicates the amount of usable space in the oven cavity in litres.

Benefit

Gas hob

Gas provides constant control of the heat source, with an immediate change in temperature

Equipped with a thermocouple, the gas supply is cut off if the flame is extinguished for greater safety

Ever Clean Enamel

Easy oven cleaning thanks to the special antacid lining which helps to reduce the amount of dirt adhering to the surface.

Buttons control

Easy and intuitive timer setting with a simple buttons

Circulaire

The best cooking performances guaranteed by ventilated circular flow.

Multiple fans and heating elements guarantee the perfect aerodynamic heat flow, allowing homogeneous and quicker cooking inside the cavity.

Multilevel cooking

Several cooking levels allow maximum flexibility of use

Multilevel halogen light

Internal halogen lighting on different levels guarantees excellent visibility

Removable inner glass

Internal door glasses are easily removable for complete cleaning

Tangential cooling

New cooling system with tangential fan and airflow from the door to the splashback

Telescopic guides

Easy extraction and safe insertion of trays into the oven thanks to telescopic guides

Adjustable height

Cooker top flushed with the working area thanks to adjustable feet

Pizza stone (optional accessory)

Baking with refractory stone for soft and crispy pizza and yeast products (STONE optional accessory)

BBQ (optional accessory)

Barbeque cooking directly in the oven with the double-sided grill

AirFry (AIRFRY optional accessory)

Lighter and tastier food thanks to airfry basket

Cold door

During any function, the external door glass is cold, avoiding any risk of burns

Isothermic Cavity

The best cooking performance at the highest energy efficiency