

TR62IBL2

Cooker size	60x60 cm
N. of cavities with energy label	2
Cavity heat source	Electric
Hob type	Induction
Type of main oven	Thermo-ventilated
Type of second oven	Static
EAN code	8017709309541
Energy efficiency class	A
Energy efficiency class, second cavity	A



Aesthetics



Aesthetics	Victoria	Control knobs	Smeg Victoria
Design	Victoria	Controls colour	Stainless steel
Colour	Black	No. of controls	6
Finishing	Gloss	Serigraphy colour	Silver
Command panel finish	Enamelled metal	Display	electronic 5 buttons
Logo	assembled 50's	Door	With frame
Logo position	Upstand	Glass type	Black
Upstand	Yes	Handle	Smeg Victoria
Hob colour	Black enamel	Handle Colour	Brushed stainless steel
Type of control setting	Control knobs	Plinth	Anthracite

Programs / Functions

No. of cooking functions 4
 Traditional cooking functions



Static



Small grill



Large grill



Base

Hob technical features



Total no. of cook zones 4

Front left - Induction - single - 2.30 kW - Booster 3.00 kW - - Ø 21.0 cm
 Rear left - Induction - single - 1.20 kW - Booster 1.40 kW - - Ø 16.0 cm
 Rear right - Induction - giant - 2.30 kW - Booster 3.00 kW - - Ø 21.0 cm
 Front right - Induction - single - 1.20 kW - Booster 1.40 kW - - Ø 16.0 cm

No. of cooking zones with Booster	4	Minimum pan diameter indication	Yes
Automatic switch off when overheat	Yes	Selected zone indicator	Yes
Automatic pan detection	Yes	Residual heat indicator	Yes

Main Oven Technical Features



No. of lights	1	Removable door	Yes
Fan number	1	Full glass inner door	Yes
Net volume of the cavity	61 litres	Removable inner door	Yes
Gross volume, 1st cavity	70 l	Total no. of door glasses	3
Cavity material	Easy clean enamel	No. of thermo-reflective door glasses	1
Shelf positions	4	Safety Thermostat	Yes
Type of shelves	Metal racks	Cooling system	Tangential
Light type	Halogen	Usable cavity space dimensions (HxWxD)	316x460x412 mm
Light power	40 W	Temperature control	Electro-mechanical
Cooking time setting	Start and Stop	Circular heating element - Power	2700 W
Door opening	Flap down		

Options Main Oven

Timer	Yes	Minimum Temperature	50 °C
End of cooking acoustic alarm	Yes	Maximum temperature	245 °C

Second Oven Technical Features



Net volume of the second cavity	35 litres	No. total door glasses	3
Gross volume, 2nd cavity	41 l	No. thermo-reflective door glasses	1
Cavity material	Easy clean enamel	Safety Thermostat	Yes
Shelf positions	2	Cooling system	Tangential
Type of shelves	Metal racks	Usable cavity space dimensions (HxWxD)	169x440x443 mm
No. of lights	1	Temperature control	Electro-mechanical
Light type	Halogen	Lower heating element - power	1200 W
Light power	40 W		

Door opening	Flap down	Upper heating element - Power	1000 W
Removable door	Yes	Grill element - power	1700 W
Full glass inner door	Yes	Large grill - Power	2700 W
Removable inner door	Yes	Grill type	Electric
		Tilting grill	Yes

Options Auxiliary Oven

Minimum Temperature	50 °C	Maximum temperature	245 °C
---------------------	-------	---------------------	--------

Accessories included for Main Oven & Hob



Chrome shelf with back and side stop	2	Grill mesh	1
40mm deep tray	1	Telescopic Guide rails, total Extraction	1

Accessories included for Secondary Oven

Chrome shelf with back and side stop	1	Grill mesh	1
40mm deep tray	1		

Electrical Connection

Max Power Draw	12700 W	Type of electric cable	Yes, Single phase
Current	38 A	Additional connection modalities	Yes, Double and Three Phase
Voltage	220-240 V	Frequency	50/60 Hz
Voltage 2 (V)	380-415 V	Terminal block	5 poles

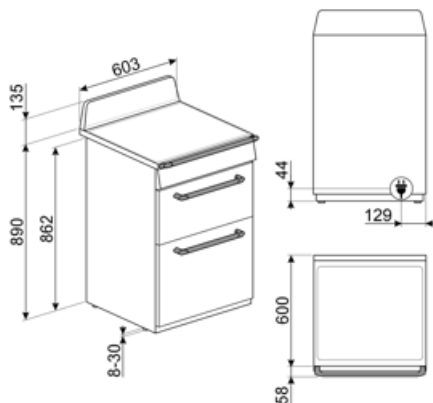

Compatible Accessories

AIRFRY

Air fryer rack AIRFRY . Ideal for recreating traditional frying in the oven, but with fewer calories and less fat. It allows you to cook quickly and simply dishes such as French fries, fried vegetables and fish, ensuring perfect browning and crispiness.



BN620-1

Enamelled tray, 20mm deep



BNP608T

Teflon-coated tray, 8mm depth, to be placed on the grid



GTP

Partially extractable telescopic guides (1 level) Extraction: 300 mm Material: Stainless steel AISI 430 polished



KIT1TR6N

Splashback, 60x75 cm suitable for 60 cm Victoria cookers, black



PALPZ

Pizza shovel with fold away handle width: 315mm length : 325mm



SFLK1

Child lock



BBQ

Double sided plate BBQ. Suitable for recreating succulent and crispy dishes in the oven with the typical taste of grilled cooking. The ribbed side is particularly suitable for meats and cheeses. The smooth side for fish, seafood and vegetables.



BN640

Enamelled tray, 40mm deep

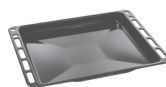

GRILLPLATE

Universal griddle for induction, gas, ceramic and electric hobs. Non-stick surface ideal for cooking meat, cheese and vegetables. Dimensions: 410 x 240 mm.



GTT

Totally extractable telescopic guides (1 level) Extraction: 433 mm Material: Stainless steel AISI 430 polished



KITH60

Height extension kit (950 mm), suitable for TR60 cookers



SCRP

Induction and ceramic hobs and teppanyaki scraper



SMOLD

Set of 7 silicone moulds for ice creams, ice lollies, pralines, ice cubes or to portion food. Usable from -60°C to +230°C

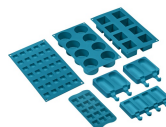

STONE

Rectangular refractory stone. Ideal for cooking pizzas with the same results as a typical wood-fired oven. Can also be used for baking bread, focaccias and other recipes such as pies, flans or biscuits Dimensions: L42 x H1,8 x P37,5 cm.

































TPKPLATE

Universal plate for induction, gas, ceramic and electric hobs. Non-stick surface ideal for cooking fish, eggs and vegetables. Dimensions: 410 X 240 mm.



Symbols glossary

 <p>P Power booster: option allows the zone to work at full power when very intense cooking is necessary.</p>	 <p>Child lock: some models are fitted with a device to lock the programme/cycle so it cannot be accidentally changed.</p>
 <p>A A: Product drying performance, measured from A+++ to D / G depending on the product family</p>	 <p>Installation in column: Installation in column</p>
 <p>Knobs control</p>	 <p>Air cooling system: to ensure a safe surface temperatures.</p>
 <p>Triple glazed doors: Number of glazed doors.</p>	 <p>ECO-logic: option allows you to restrict the power limit of the appliance real energy saving.</p>
 <p>Enamel interior: The enamel interior of all Smeg ovens have a special antacid lining which helps keep the interior clean by reducing the amount of cooking grease adhering to it.</p>	 <p>Upper and lower element only: a traditional cooking method best suited for single items located in the centre of the oven. the top pf the oven will always be hottest. Ideal for roast, fruit cakes, bread etc.</p>
 <p>Lower heating element only: This function is ideal for foods that require extra base temperature without browning, e.g. pastry dishes, pizza. Also suitable for slow cooking of stews and casseroles.</p>	 <p>Circulaire: The combination of the fan and circular element around it gives a hot air cooking method. This provides many benefits including no preheat if cook time is more than 20 minutes, no flavour transfer when cooking different foods at the same time, less energy, and shorter cook times. Good for all types of food.</p>
 <p>Grill element: Using of grill gives excellent results when cooking meat of medium and small portions, especially when combined with a rotisserie (where possible). Also ideal for cooking sausages and bacon.</p>	 <p>Half grill: For rapid cooking and browning of foods. Best results can be obtained by using the top shelf for small items, the lower shelves for larger ones, such as chops or sausages. For half grill heat is generated only at the centre of the element, so is ideal for smaller quantities.</p>
 <p>Light</p>	 <p>Giant zone: The giant zone offers extra space and flexibility.</p>
 <p>Overheat protection: The safety system that automatically turns off the hob in case of overheating of the control unit.</p>	 <p>Induction: The work of these hobs is based on the principle of electromagnetic induction. The heat is generated directly in the bottom of the pan during its contact with the hob.</p>
 <p>All glass inner door: All glass inner door, a single flat surface which is simple to keep clean.</p>	 <p>The inner door glass: can be removed with a few quick movements for cleaning.</p>
 <p>Side lights: Two opposing side lights increase visibility inside the oven.</p>	 <p>Automatic opening: some models have Automatic opening door when the cycle is finished which is a perfect solution for handle-less kitchen units as no handle is needed. For safety reasons, the door locks automatically when the machine is in use to avoid it being opened inadvertently.</p>

-
-  Indication of residual heat: After the glass ceramic hob is switched off the residual heat indicator shows which of the heating zones still remains hot. When the temperature drops below 60 ° C, the indicator goes out.
 -  The oven cavity has 4 different cooking levels.
 -  Electronic control: Allows you to maintain temperature inside the oven with the precision 2-3 ° C. This enables to cook meals that are very sensitive to temperature changes, such as cakes, souffles, puddings.
 -  The capacity indicates the amount of usable space in the oven cavity in litres.
 -  The oven cavity has 2 different cooking levels.
 -  Telescopic rails: allow you to pull out the dish and check it without having to remove it from the oven entirely.
 -  Tilting grill: the tilting grill can be easily unhooked to move the heating element and clean the roof of the appliance in one simple step.
 -  The capacity indicates the amount of usable space in the oven cavity in litres.

Benefit

Induction hob

Induction offers fast cooking and precise temperature control

Through the use of suitable cookware, induction is easy to use and maintain, safe and responsive

Ever Clean Enamel

Easy oven cleaning thanks to the special antacid lining which helps to reduce the amount of dirt adhering to the surface.

Buttons control

Easy and intuitive timer setting with a simple buttons

Circulaire

The best cooking performances guaranteed by ventilated circular flow.

Multiple fans and heating elements guarantee the perfect aerodynamic heat flow, allowing homogeneous and quicker cooking inside the cavity.

Multilevel cooking

Several cooking levels allow maximum flexibility of use

Multilevel halogen light

Internal halogen lighting on different levels guarantees excellent visibility

Removable inner glass

Internal door glasses are easily removable for complete cleaning

Tangential cooling

New cooling system with tangential fan and airflow from the door to the splashback

Telescopic guides

Easy extraction and safe insertion of trays into the oven thanks to telescopic guides

Adjustable height

Cooker top flushed with the working area thanks to adjustable feet

Pizza stone (optional accessory)

Baking with refractory stone for soft and crispy pizza and yeast products (STONE optional accessory)

BBQ (optional accessory)

Barbeque cooking directly in the oven with the double-sided grill

AirFry (AIRFRY optional accessory)

Lighter and tastier food thanks to airfry basket

Cold door

During any function, the external door glass is cold, avoiding any risk of burns

Isothermic Cavity

The best cooking performance at the highest energy efficiency

Single turbine

The oven has a fan equipped with a circular heating element allowing cooking with rotating heat