

WMI147C

EAN Code	8017709302825
Product Family	Washing Machine
Commercial width	60 cm
Commercial depth	Standard capacity
Installation	Fully integrated
Load type	Frontal



Programme / Functions

Controls

Programmes graphics

No. of programmes

Programmes

Electronic

Written in EN

15

Eco 40-60



Cotton 20°



Cotton 40°



Cotton 60°



Cotton 90°



Mix 30°



Synthetics 40°



Synthetics 30°



Wool Cold



Delicate 30°



Wool 30°



Synthetics Cold



Quick Wash 15' 30°



Drain + Spin



Rinse + Spin

Washing Temperature

Cool

20°C

30°C

40°C

60°C

90°C

Special programmes



Wool



Mix



Quick 30 min



Sport

Display

Residual time indicator

delay start

Recommended load indicator

programme status indication

Display type



Buttons/Options



Delay timer



Prewash



Additional rinse



No spin



Rinse hold



Anti-wrinkle (easy ironing)



Intensive

On/off indicator (light)

Yes

Programme progress indicator (light)

On display

End of cycle indicator (light)



Technical Features



Type of motor Standard

Electronic control functioning Yes

Programme selection knob Yes

Programme/temperature selection knob Yes

Spin speed selection on display/LED No spin/ 600/ 800/ 1000/ 1200/ 1400

Polypropilene tank Yes

Basket Stainless steel

Drum capacity 52 l

Liquid detergent accessory as standard Yes

Door diameter 30 cm

Door opening 110°

Automatic variable load Yes

Antifoam system Yes

Load balancing system Automatic

Easy to access filter Yes

Child lock (functions block) Control block

Anti-flood system Yes

Furniture door can be fitted on right or left side with adjustable hinges Yes

Performance / Energy Label



Load capacity 7 kg

Max spin speed 1400 rpm

Energy efficiency class A++

Washing efficiency class A

Spin efficiency class B

Energy rating A++B

Noise level washing 56 dB(A) re 1pW

Total time cycle - 150 min

Cotton 60° full load

Energy consumption - Cotton 60° half load 0.82 kWh

Total cycle time - 150 min

Cotton 60° half load

Energy consumption - Cotton 40° half load 0.64 kWh

Noise level spinning	72 dB(A) re 1pW	Total cycle time - Cotton 40° half load	150 min
Normative programmes	Cotton 60° and Cotton 40°	Total annual energy consumption (Washing)	193 KWh
Energy consumption - Cotton 60° full load	1.03 KWh	Total annual water consumption	10340 l
		Energy consumption - Stand by left on mode	0.8 W
		Energy consumption - Stand by off mode	0.2 W

Performance / Energy Label NEW



Supplier's name or trademark	SMEG	Spin-drying efficiency class	B
Rated Capacity	7 kg	Airbone acoustical noise class	A
Energy Efficiency Class	E	Airbone acoustical noise	72 dB(A) re 1 pW
Energy_cons_100	77 KWh	Programme duration at rated capacity	2:50 h:min
Water Consumption	44 litres		

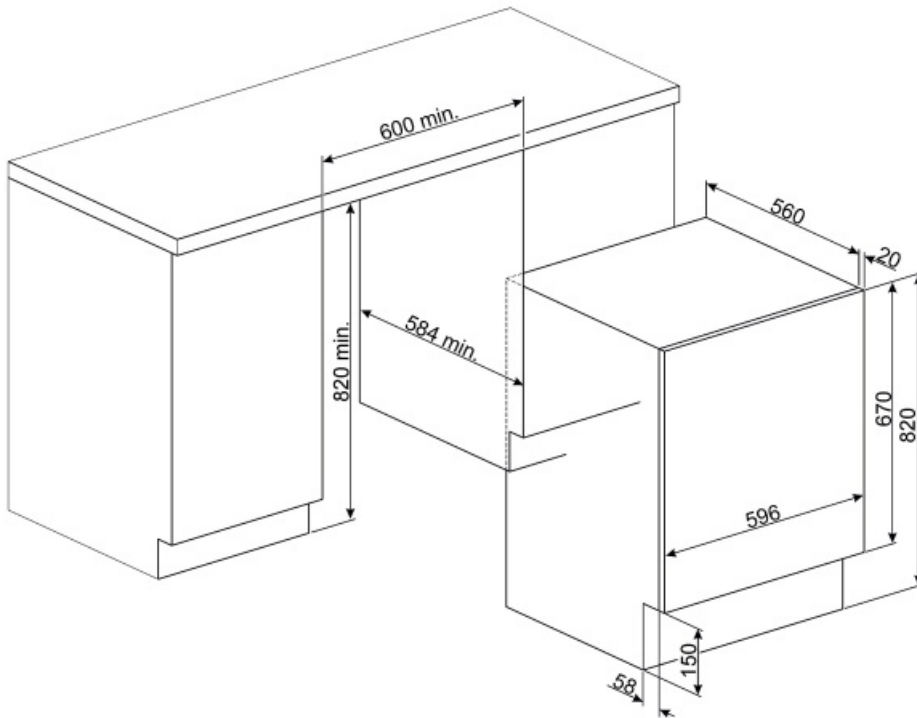

Not included accessories



KITWDHE1























5 cm. raising Kit for fully integrated dishwashers and washer dryers















KITPLV2

Kit extension for dishwasher and washing machine: length mt. 2

Symbols glossary

 <p>A++: Energy efficiency class A++ helps to save up to 20% energy compared to class A. Maximum performance with minimum consumption is guaranteed.</p>	 <p>Easy Iron: this is an option which can be selected to ensure the finished laundry is left with less creases to make ironing easier.</p>
 <p>Variable load: In all models of washing machines is present the system of variable load, according to which the machine automatically diversifies the wash cycle and the time of operation depending on the quantity and type of laundry introduced, allowing a significant saving of water and energy power, up to 30% compared to the versions with fixed load.</p>	 <p>Automatic Load Balancing: provides an ideal distribution of laundry in the drum. In case if the imbalance is detected, the rotation speed starts being controlled in such way to evenly redistribute laundry in the drum, and thus reduce vibration.</p>
 <p>Acoustic signal: informs about the end of the drying cycle, in order to to get things out in time and avoid excessive creasing.</p>	 <p>Child lock: some models are fitted with a device to lock the programme/cycle so it cannot be accidentally changed.</p>
 <p>Delay timer: can be set to run the programme at a convenient time or to take advantage of off-peak energy periods.</p>	 <p>LED display: to show programmes, functions and options selected and the time to the end of the cycle.</p>
 <p>30 cm: Large loading hatch of 30-32-33 cm in diameter, makes laundry loading and unloading easier and faster with maximum ease of use.</p>	 <p>This option advises when the periodic cleaning of the filters is needed, in order to avoid forgetfulness and thus guarantee the perfect functioning of the dryer over time. The convenient position of the filters makes maintenance fast and extremely simple.</p>
 <p>Intensive: this option intensifies the selected program. Cycle duration and water consumption are reduced by taking into account the type of laundry, while still guaranteeing excellent washing results, even in the case of stains that are difficult to eliminate.</p>	 <p>No spin option: this option allows to exclude the last spin phase, draing the water from the tank</p>
 <p>Prewash: program designed for heavily soiled garments.</p>	 <p>For lightly soiled fabrics in cotton and linen</p>
 <p>Cotton 40°: For soiled fabrics in cotton</p>	 <p>Cotton 60°: For soiled fabrics in cotton</p>
 <p>Cotton 90°: For soiled fabrics in cotton</p>	 <p>Delicate 30°: Clothing such as underwear, hosiery and luxury fabrics should be dried on the delicate cycle to help extend the life of the clothing.</p>
 <p>To drain the water in the machine.</p>	 <p>Extra Rinse: Extra Rinse: adds an extra rinse cycle to that already provided in the program chosen, to remove any residual detergent. This function is particularly suitable for those with allergies or skin problems.</p>
 <p>Mix 30°: washing program that allows to to wash your cotton and synthetic clothes together without sorting them.</p>	 <p>Mixed fabrics: this cycle is designed for lightly soiled laundry in a mix of cottons and synthetics, or can be used just to refresh stored items.</p>

-
- | | | | |
|---|--|---|---|
|  | Rapid 15-30 ° : Rapid washing program at 30 °, let to clean slightly dirty items in a very short time. |  | Super fast 30 min: a programme designed to wash small amounts of laundry fast, ideal for washing lightly soiled garments. |
|  | Terminato il lavaggio il ciclo si blocca con l'acqua in vasca |  | To drain the water into the basket + centrifuge action |
|  | Gym: Gym, a cycle designed for washing lightly soiled garments, ie sports wear, this is a fast wash which is also kind to fabrics. |  | Synthetic 30 °: washing program at 30 ° for Synthetics items |
|  | Synthetic 40 °: washing program at 30 ° for Synthetics items |  | Synthetics: Synthetics washing program is designed for non-cotton items that need a slightly more delicate wash |
|  | Wool 30°: this programme for wool or delicate fabrics uses slower rotations of the drum to ensure the utmost care for clothing. |  | Wool: this programme for wool or delicate fabrics uses slower rotations of the drum to ensure the utmost care for clothing. |
|  | Wool Cold: this programme for wool or delicate fabrics uses slower rotations of the drum to ensure the utmost care for clothing. |  | Drum has maximum capacity of 7kg of dry laundry. |
|  | Energy efficiency class E | | |