

DIMENSIONS

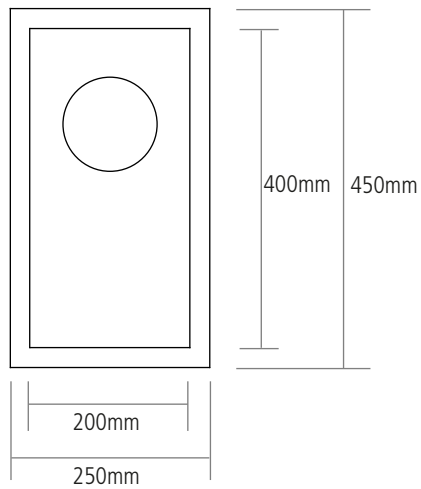

BOWL DEPTH: 140MM

MIN. BASE UNIT: 300MM

UNDERMOUNT CUT-OUT SIZE: 200 x 400MM

INSET CUT-OUT SIZE: 229 x 429MM

NOTE: For cut-out shape go to www.caple.co.uk for template